

Krmiljenje hladilnih sistemov

Control in Refrigeration Systems

Janez Primožič - Rajko Svečko

Prispevek predstavlja krmiljenje hladilnih sistemov. Namen raziskave je pomoč pri projektiranju hladilnih sistemov oziroma pri določevanju optimalnih parametrov, ki vplivajo na delovanje hladilnih sistemov. Za obravnavo je bila potrebna analiza trenutnega stanja ponudnikov oziroma izdelovalcev opreme za krmiljenje hladilnih sistemov. Opremo lahko delimo na dva dela. Obstaja oprema za krmiljenje preprostih hladilnih sistemov, ki se največkrat sestoji iz elektronskih termostatov za krmiljenje elementov v hladilnih komorah ali miniaturnih mikroprocesorskih naprav za krmiljenje manjših kompresorskih agregatov. Uporaba našete opreme je postala že širokoporabna, tako da sta njena prednost nizka cena in preprosta uporaba. Slabe lastnosti omenjene opreme pa so predvsem neuporabnost za zahtevnejše hladilne sisteme ter nezmožnost optimizacije hladilnih sistemov v smislu povečevanja hladilnega števila in varčevanja z električno energijo.

Poudarek prispevka je zaradi naštetih dejstev predvsem v krmiljenju zahtevnejših hladilnih sistemov z uporabo prostoprogramljivih mikroprocesorjev in sistema SCADA.

© 2004 Strojniški vestnik. Vse pravice pridržane.

(Ključne besede: sistemi hladilni, sistemi krmilni, naprave krmilne, sistemi SCADA)

This paper describes the control of refrigeration systems. The goal of the research is to support the design of refrigeration systems and to define the optimum parameters that influence refrigerating systems. A second aim of the investigation was an analysis of currently available control equipment for refrigeration systems and the producers. The equipment can be divided into two segments: equipment for the control of simple refrigeration systems, which consists of electronic thermostats for controlling the elements of the refrigeration rooms; and miniature microprocessor-based equipment used for controlling the smallest compressor aggregates. The advantages of this equipment are its wide consumption, low cost and simple usage. Its drawbacks are inappropriateness for complex refrigeration systems in the sense of increasing the coefficient of performance (COP) and the consumption of electrical energy.

The main emphasis of the paper is on the control of complex refrigeration systems based on programmable microprocessors and SCADA (supervisory control and data acquisition) systems.

© 2004 Journal of Mechanical Engineering. All rights reserved.

(Keywords: refrigeration systems, control systems, control equipment, SCADA systems)

0 UVOD

Hladilni sistemi, ki jih prispevek obravnava, so parni krožni postopki na podlagi Carnotovega hladilnega krožnega postopka ([1] do [3]). Tehnologije izdelave hladilnih strojev so na področju strojništva dobro znane, ker pa je krmiljenje močno povezano s področjem avtomatike, se pojavlja potreba po poglobljenem razumevanju delovanja krmilnih sistemov hladilnih naprav. Z vidika strojništva pomeni razumevanje avtomatike izraba vseh prednosti, s katerimi lahko izboljšamo delovanje hladilnih sistemov. Z vidika avtomatike je razumevanje fizikalnega ozadja

0 INTRODUCTION

The refrigeration systems dealt with in this article employ vapour-cycle processes based on the Carnot refrigeration cycle ([1] to [3]). In mechanical engineering, the technology of producing refrigeration machines is well known, however, their control is closely connected to automation. Therefore, it is vital to go into further details on the working process of the control system of refrigeration machines. To really understand automation, from the point of view of mechanical engineering, means to make good use of the advantages by which the work of refrigeration systems can be improved. From the automation point of view, for

delovanja hladilnih sistemov pogoj za kakovostno izdelano krmilje.

Prispevek opisuje načine krmiljenja neposrednih in posrednih hladilnih sistemov. Izdelana je primerjava med krmiljenjem z uporabo namenskih elektronskih termostatov in prostoprogramljivih mikropostopkorskih krmilnikov. Glavni del obravnave je namenjen predstavitvi krmiljenja hladilnih sistemov s prostoprogramljivimi mikroprocesorskimi krmilniki [8]. Rezultat obravnave so algoritmi, ki omogočajo optimalno krmiljenje zahtevnih hladilnih sistemov, tako na ravni kompresorskega agregata kakor tudi elementov v samem prostoru, ki ga hladimo.

1 HLADILNI SISTEMI

Hladilne sisteme lahko glede na način prenosa toplote delimo na neposredne in posredne. Razlog navedbe teh dveh tipov hladilnih sistemov je v tem prispevku prav ta, da se krmiljenje enega in drugega načina razlikuje.

Neposredni hladilni sistem sestavljajo glavni štirje elementi: kompresor ali sklop kompresorjev, kondenzator, ekspanzijski ventil in uparjalnik oziroma sklop uparjalnikov. Celoten sistem je napolnjen z enim hladivom. Krmiljenje takšnega sistema bo opisano v naslednjih poglavjih.

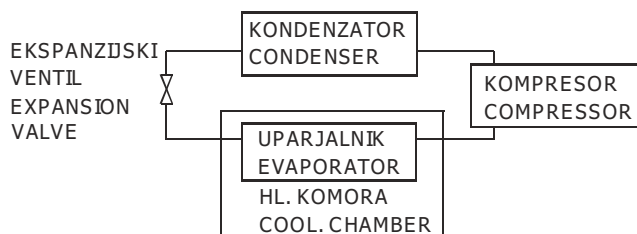

Sl. 1. *Neposredni hladilni sistem*
Fig. 1. *The direct refrigeration system*

Posredni hladilni sistem je sistem sestavljen iz dveh delov. Primarni del je zelo podoben neposrednemu sistemu, le da uparjalnik namesto zraka hladi sekundarno hladivo, to je hladilna mešanica vode in propilen glikola ali etilen glikola [4]. V sekundarnem delu pa v hladilniku zraka s kroženjem hladnega sekundarnega hladiva, hladimo zrak v hlajenem prostoru (hladilni komori).

Postopek, ki pri neposrednem hladilnem sistemu za hlajenje zraka poteka v hlajenem prostoru, pri posrednem sistemu poteka v uparjalniku za hlajenje sekundarnega hladiva. Hladivo torej v primarnem delu uparjalnika prehaja v plinasto fazo in pri tem odvzema toploto sekundarnemu hladivu v sekundarnem delu uparjalnika. Sekundar uparjalnika tako hladi hladilno mešanico, ki jo imamo na želenem temperaturnem režimu stalno pripravljeno v zbiralniku hladilne mešanice.

qualitative control, it is vitally important to understand the physical background to refrigeration systems.

The article describes methods of control for direct and indirect refrigeration systems. A comparison has been made between control using electronic thermostats and control using programmable controllers. The main part of the discussion is the presentation of control using programmable microprocessor controllers [8]. This results in algorithms that enable optimum control of complex refrigeration systems at the level of compressor aggregates as well as the elements in the cooled room.

1 REFRIGERATION SYSTEMS

Depending on the way the heat is transmitted, refrigeration systems can be put into two categories: direct and indirect. The reason for discussing these two is the fact that the control of the first differs from the control of the second.

The direct refrigeration system consists of four elements: a compressor (or a set of compressors), a condenser, an expansion valve and an evaporator (or a set of evaporators). The entire system is filled with a single refrigerant. The control of this kind of system is described later.

The indirect refrigeration system consists of two parts. The first part resembles the direct system, it is different only in that the evaporator cools a secondary medium instead of air. The secondary medium is a cooling mixture of water and propylene glycol or ethylene glycol [4].

The phenomenon which occurs in the evaporator (in the cold store) in the direct system, takes place in the cooling-mixture evaporator in the indirect system. The transition of the refrigerant into a gas takes place in the cooling-mixture evaporator where it decreases the heat of the cooling mixture that is going through the exchanger. The secondary circuit of the heat exchanger cools the cooling mixture, which is maintained at the desired temperature in the reservoir.

Na ravni hladilne komore imamo hladilnik, ki je po obliki podobno uparjalniku. Ne moremo ga imenovati uparjalnik, saj se v njem ne opravlja uparjanje. Hladilna mešanica potuje skozi hladilnik in na ta način odvzema toploto hlajenemu prostoru – komori. V bližini hladiva, najpogosteje pa kar zunaj komore, imamo naslednje elemente za krmiljenje temperature v komori:

- črpalko hladilne mešanice Č,
- tripotni ventil hladilne mešanice T,
- temperaturno zaznavalo hladilne mešanice TIC,
- boljer z grelcem za odtaljevanje hladilnika z zaščitnim termostatom B.

Krmiljenje elementov na primarni strani prenosnika toplote poteka enako kakor pri neposrednem sistemu, medtem ko ima krmiljenje sekundarnega dela svoje posebnosti, ki bodo predstavljene v nadaljevanju.

In the cold store there is a cooler, which is a similar shape to the evaporator. However, it cannot be called an evaporator, because there is no evaporation occurring inside it. The cooling mixture flows through the cooler and, in this way, decreases the temperature of the chamber that is being cooled. Near the cooler or, frequently, outside the chamber, there are the following elements for controlling the temperature of the chamber:

- a pump for the cooling mixture P,
- a three-way valve for the cooling mixture V,
- a temperature probe for the cooling mixture TIC,
- a boiler with a heater for defrosting the cooler (with a protection thermostat H).

The element control on the primary circuit of the heat exchanger works the same as in the direct system, while the secondary-circuit control has its specific features, dealt with later on in the article.

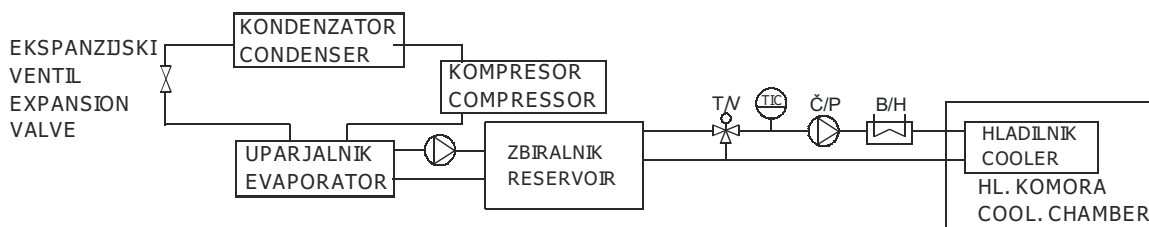

Sl. 2. Posredni hladilni sistem
Fig. 2. The indirect refrigeration system

2 KRMILJENJE HLADILNIH SISTEMOV

2 CONTROL IN REFRIGERATION SYSTEMS

2.1 Krmiljenje preprostega hladilnega sistema

2.1 Simple refrigeration system control

Preprosti hladilni sistem, delujoč po načelu uparjanja in kompresije hladiva, je sestavljen iz kompresorja, kondenzatorja, uparjalnika in ekspanzijskega ventila.

The simple refrigeration system, which works by the evaporation and refrigerant compression principle, consists of the compressor, the condenser, the evaporator and the expansion valve.

Krmiljenje opisanega preprostega hladilnega sistema je v praksi večinoma izvedeno z elektronskimi termostati. Elektronski termostat s temperaturnim tipalom dobiva podatek o temperaturi v hladilni komori. Glede na izmerjeno temperaturo in v samem elektronskem termostatu nastavljeno zeleno temperaturo vključuje elemente hladilnega sistema. Če se temperatura v komori zviša nad zeleno temperaturo s pozitivno razliko, se vključi hlajenje. To pomeni, da elektronski termostat vklopi kompresor, ventilatorje kondenzatorja, polnilni ventil ter ventilatorje uparjalnika. Po doseženi zeleni temperaturi v komori se naštetni elementi hkrati izklopijo, dokler ni ponovne potrebe po hlajenju.

In practice, the described simple refrigeration system is executed with the help of electronic thermostats. The electronic thermostat obtains the information on temperature in the cold store with the help of the temperature probe. It switches on elements of the cooling system in accordance with the measured temperature and the set temperature in the electronic thermostat. As the temperature in the chamber rises above the desired temperature plus the difference, the cooling is switched on. In other words, the electronic thermostat switches on the compressor, the fans of the condenser, the expansion valve, and the fans of the evaporator. As the desired temperature in the chamber is reached, these elements are switched off simultaneously, and stay off until the next cooling situation.

Kakor je bilo omenjeno že v prejšnjih poglavjih, je treba uparjalnik redno odtaljevati. V ta namen ima elektronski termostat možnost nastavitve parametrov odtaljevanja. Tako lahko izbiramo med naslednjimi nastavitvami:

- časom med odtaljevanji (ta čas je lahko dejanski čas ali čas delovanja hlajenja in znaša od štiri do osem ur, kar je odvisno od skladiščenega blaga oziroma odprtosti vrat hladilne komore);
- najdaljše trajanje odtaljevanja;
- temperaturo na lamelah uparjalnika, ki izklopi odtaljevanje;
- čas odcejanja po odtaljevanju (to je čas, ko električni grelniki ne delujejo več in se kapljice le še odcedijo iz uparjalnika);
- zakasnitev ventilatorjev po odcejanju (kapljice vode, ki so se zaradi odtaljevanja pojavile na uparjalniku, bi z vklopom ventilatorjev razpršilo po prostoru in blagu, ki ga hladimo. Navzlic temu najprej za kratek čas vklopimo hlajenje brez ventilatorjev uparjalnika in tako dosežemo, da kapljice na uparjalniku zamrznejo in se ne razpršijo po prostoru.).

Pri navedenem krmiljenju hladilnega sistema ne moremo govoriti o kakršnikoli optimizaciji sistema v pomenu povečevanja hladilnega števila oziroma povečevanju energijske učinkovitosti.

The evaporator must be defrosted regularly. For this reason, it is possible to set the defrosting parameters on the electronic thermostat.

We can choose among the following settings:

- the time period between the defrosting acts (the actual time or the cooling period time; that is somewhere between four and eight hours, depending on the stored goods or the period of time the doors of the cold store are open)
- the maximum duration of the defrosting process
- the temperature on the evaporator fins, which switches off the defrosting process
- the dripping time after the defrosting act (the time when the electric heaters have stopped working and the drops are dripping out of the evaporator)
- the fan delay after dripping time (the drops of water which appear on the evaporator would be sprayed about the cold store and across the goods by switching on the fans. Instead, we switch on the cooling without the fans of the evaporator first, and ensure that the drops freeze on the evaporator and are not sprayed about.)

With this kind of refrigeration system control, we cannot speak about optimizing the system in the sense of increasing the COP or the energy efficiency.

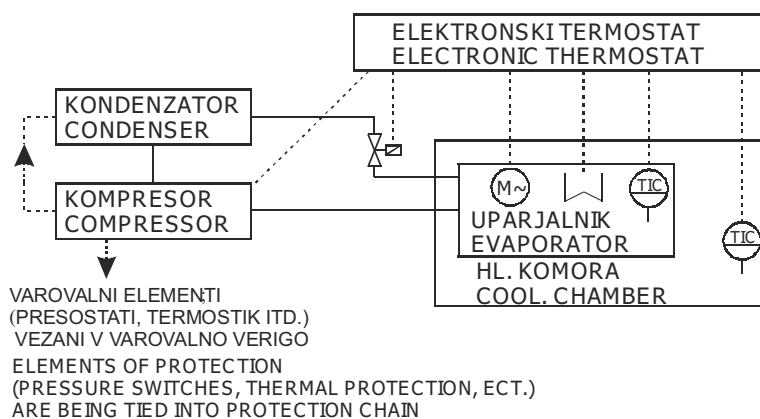

Sl. 3. Shema enostavnega hladilnega sistema s pripadajočim krmiljenjem
Fig. 3. A scheme of the simple refrigeration system and its control

2.2 Krmiljenje zapletenega neposrednega hladilnega sistema

Zapleteni hladilni sistem se v primerjavi s preprostimi hladilnimi sistemi razlikuje v naslednjem:

- sestavlja ga večje število hladilnih komor oziroma uparjalnikov,
- sestavlja ga večje število kompresorjev,
- zračni kondenzator je večji (tudi večje število ventilatorjev) in deluje stopenjsko.

Pri takšnih hladilnih sistemih je smiselna uporaba mikroprocesorskih krmilnikov, pri katerih lahko v vsakem

2.2 Complex refrigeration system control

The complex refrigeration system differs from the simple refrigeration system in the following ways:

- it consists of more cooling chambers or evaporators
- it consists of more compressors
- the air condenser is bigger (and has more fans); it works in stages.

It is reasonable to use microprocessor control in this kind of refrigeration system, for we can take into consideration all states of the system

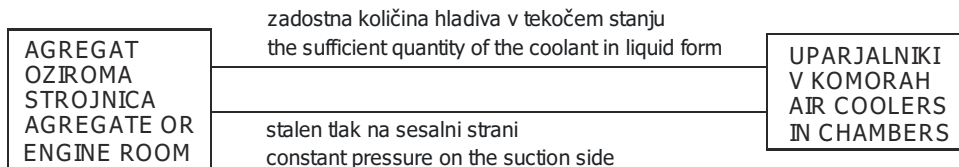

Sl. 4. Načelna shema zapletenega neposrednega hladilnega sistema
 Fig. 4. The principle of the complex refrigeration system

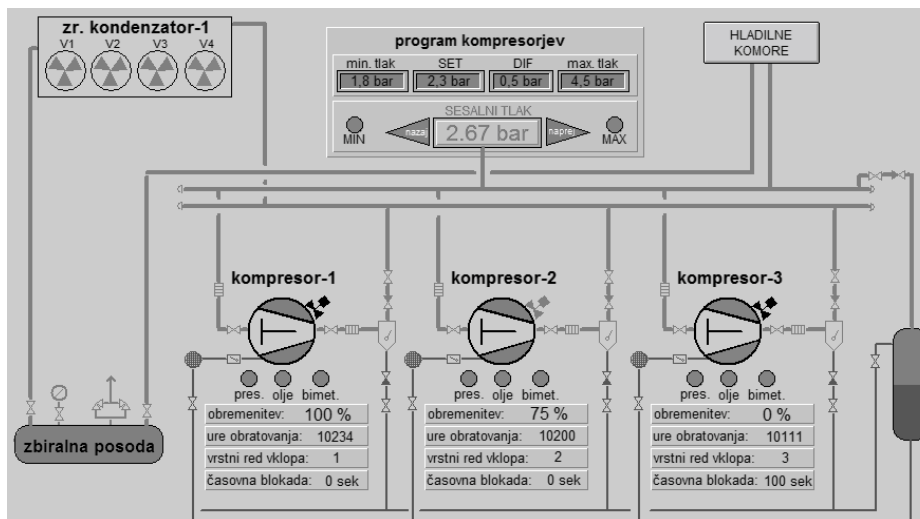

Sl. 5. Vzporedna vezava treh kompresorjev

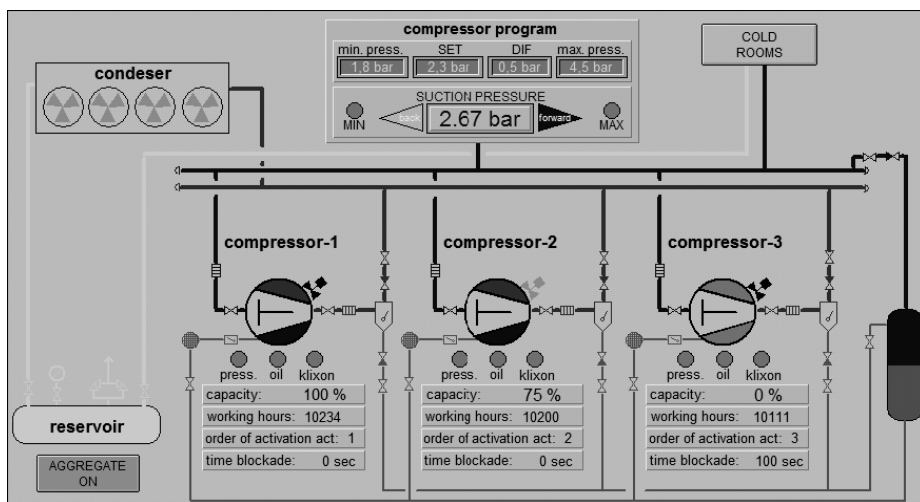

Fig. 5. Parallel binding of the three compressors

trenutku upoštevamo vsa stanja sistema in s tem na sistem vplivamo tako, da je učinek sistema največji [6].

Prvi del zapletenega hladilnega sistema je kompresorski agregat, pri večjih sistemih pa je lahko to vsa oprema, ki je v strojnici. Njegova naloga je, da vzdržuje stalen tlak na sesalni in tlačni strani sistema. Glavni element samega agregata hladilnega sistema

and so manipulate the system in a way that makes it most efficient [6].

The first part of the complex cooling system is a compression aggregate; in larger systems this may be the only equipment inside the engine room. The compressor aggregate preserves the pressure on a suction and a discharge side of the system. The main

je sklop kompresorjev ter zračni oziroma uparilni kondenzator z ventilatorji. Število kompresorjev kakor tudi število ventilatorjev kondenzatorja je odvisno od velikosti sistema.

Drugi del zapletenega hladilnega sistema so hladiva v posameznih hlajenih prostorih, ki skrbijo za vzdrževanje potrebnega temperaturnega režima.

2.3 Krmiljenje kompresorjev

Slika 5 prikazuje tri vzporedno vezane kompresorje, katerih naloga je vzdrževanje želene ga tlaka na sesalni strani hladilnega sistema.

Temelj za krmiljenje kompresorjev je tako imenovani računalniški program kompresorjev. V ta namen imamo na sesalnem vodu nameščeno tlačno tipalo, ki s signalom v vsakem trenutku daje informacijo o sesalnem tlaku. Sesalni tlak se v sistemu spreminja zaradi neenakomerne obremenitve s strani uporabnikov, to je dejanskega števila hladilnih komor, ki trenutno hladijo. Pogoj za vklop kompresorjev je torej povišanje sesalnega tlaka nad določeno vrednost. To vrednost imenujemo zelena vrednost (točka SET) sesalnega tlaka. Vrednost nastavljene točke SET je seveda odvisna od temperaturnega režima, za katerega je hladilni sistem narejen, oziroma od hladilnega medija.

Če sesalni tlak doseže vrednost točke SET in razliko DIF, torej SET + DIF, se prične tako imenovani program kompresorjev naprej oziroma analogno temu - pri točki SET in negativni razliki (SET - DIF) program nazaj. Opisano prikazuje tudi slika 6.

Glede na število in tehnološke zahteve hladilnih komor sta določena število in tip kompresorjev. V primeru, da imamo tri kompresorje s

elements of the aggregate are a set of compressors and an air or an evaporative condenser with fans. The number of the compressors and the number of the fans of the condenser depend on the size of the system.

The second part of the complex refrigeration system are coolers in separate rooms, which preserve the required temperature regime.

2.3 Compressor control

Figure 5 presents three parallel multiplex bound compressors. Their task is to preserve the desired pressure on the suction side of the refrigeration system.

The so-called compressor program is the basis of compressor control. For this reason, there is a pressure probe settled on the suction line. By means of a signal, the pressure probe constantly provides information on the suction pressure. The suction pressure changes due to consumers unequally loading the system. Actually, this is the number of cold stores in action. In order for compressors to be switched on, the suction pressure must rise above the set value (the SET point). The value set for the SET point depends on the temperature regime for which the cooling system is made for, or on the cooling medium.

When the suction pressure reaches the value set plus the difference (SET+DIF) the compressor program is activated, or similarly, with the set minus the difference (SET-DIF), the backward program comes into action. This is clear from Figure 6.

The number and the type of compressors are selected according to the number and the technological requirements of the cold stores.

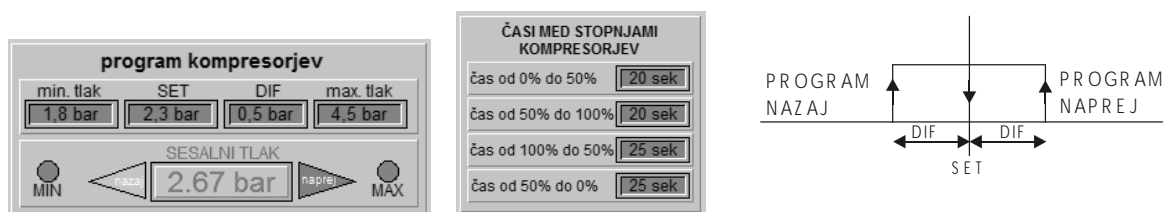

Sl. 6. Program kompresorjev naprej - nazaj

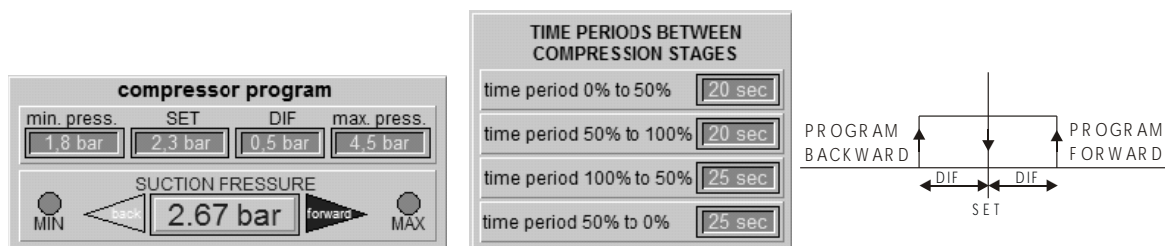

Fig. 6. Compressor program forward-backward

stopnjami 50 % ali 100 %, to pomeni, da bo celotna zmogljivost sistema kompresorjev razdeljena na 6 stopenj.

Z vklopom programa kompresorjev NAPREJ so izpolnjeni pogoji za vklop stopenj kompresorjev. Najprej se vklopi prva stopnja kompresorja, ki je prvi pripravljen za start, nato druga stopnja tega kompresorja in tako dalje do druge stopnje kompresorja, ki je kot zadnji določen za start.

Pri programu kompresorjev so zelo pomembni časi med stopnjami. V osnovi program deluje tako, da uporabnik nastavi zelene čase med stopnjami kompresorjev. Torej, ko pride do pogoja za program kompresorjev naprej, mora najprej preteči čas do vklopa prve stopnje, po vklopu le-te zopet čas do naslednje stopnje in tako dalje. Podobno je pri programu kompresorjev nazaj. Po pretečenem času se najprej izklopi druga stopnja kompresorja, ki se je vklopil zadnji, zatem po pretečenem času njegova prva stopnja in tako dalje do izklopa prve stopnje kompresorja, ki se je vklopil prvi. Večina samostojnih krmilnikov kompresorjev, ki se pojavljajo na tržišču, deluje po opisanem postopku. Naloga teh krmilnikov je torej vključevanje stopenj kompresorjev tako, da vzdržujejo sesalni tlak kar se da stalen in v bližini točke SET.

2.4 Smernice za povečanje hladilnega števila z izboljšanim krmiljenjem kompresorjev

Hladilno število, kot podatek o učinkovitosti hladilnega sistema, je določeno kot razmerje med odvedeno toploto Q_2 in vloženim delom A ([1]). Enačba hladilnega števila ima obliko:

$$\varepsilon_H = Q_2/A$$

Pri zgoraj omenjenem krmiljenju večjega števila vzporedno vezanih kompresorjev se dogaja,

Providing there are three compressors of 50 or 100% capacity degress, the entire capacity of the compressor system is divided into six stages.

All the requirements for the activation of the stages of the compressors are fulfilled by switching on the forward compressor program. Firstly, the first stage of the compressor ready to start is activated, then the second stage of the compressor, and so on, up to the second stage of the compressor, which is the last intended to be activated.

The time periods between the stages are of chief importance in the compressor program. The program works in the following process. The consumer sets the desired time values between the stages of the compressors. That is, fulfilling the requirements for activation of the forward program, a time must pass before the activation of the first stage, after that, again, time must pass to the next stage and so on. The backward program works in a similar way. After a certain time has passed, the second stage of the lastly activated compressor is stopped, after that a time period must pass and then its first stage is stopped, and so on until the first stage of the firstly activated compressor is stopped. Most of the independent compressor controllers appearing on the market work on this principle. Their task is to switch on the compressor stages, in order to keep the suction pressure as constant as possible and close to the SET point.

2.4 Guidelines for increasing the coefficient of performance (COP) by improving the compressor control

COP, in the sense of information about the efficiency of the cooling system, is defined as a ratio of the heat removal Q_2 to the work input A ([1]). The equation of COP is:

When controlling a large number of multiplex bound compressors it sometimes happens that the

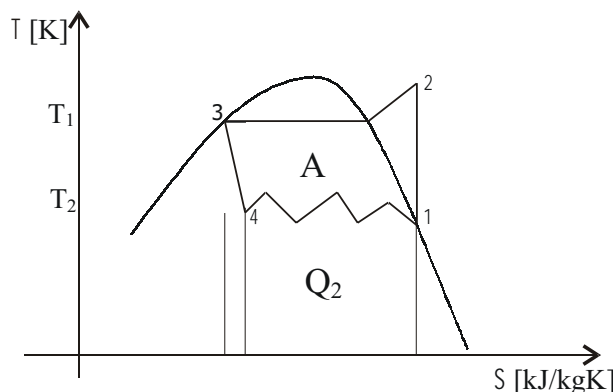

Sl. 7. Parni hladilni postopek v diagramu T-S – nihanje tlaka uparjanja
Fig. 7. Vapour cycle process in a T-S diagram - oscillating of vapour pressure

da sesalni tlak ni vedno enak, ampak se giblje v bližini točke SET. To pomeni, da na sliki 7 nimamo več premice med točkama 4 in 1, ampak neko nepravilno obliko, ki je odvisna od nihanja sesalnega tlaka. Sesalni tlak se spreminja po krivulji, katere oblika je odvisna od števila trenutno vklopljenih uparjalnikov v posameznih hlajenih prostorih ter od odvzema toplote iz le-teh. Hladilno število bi torej lahko povečali, če bi sesalni tlak vzdrževali čim višji in čimbolj stalen. Ker se naša obravnava nanaša predvsem na krmiljenje batnih kompresorjev, vezanih v vzporedni sistem, iščemo izboljšave na tem področju.

Pri izboljšanju krmiljenja kompresorjev se osredotočamo na vzdrževanje stalnega sesalnega tlaka s še večjo natančnostjo, kakor je opisano v prejšnjem poglavju.

Večjo natančnost vzdrževanja stalnega sesalnega tlaka lahko dosežemo s počasnejšim odzivom opisanega krmilja. Zamisel počasnejšega odziva je naslednja. Med spreminjanjem sesalnega tlaka procesor opazuje hitrost njegovega višanja oziroma nižanja. Če pri programu kompresorjev NAPREJ procesor zazna nižanje sesalnega tlaka, je to znak, da je v danem trenutku vklopljenih dovolj stopenj za trenutno obremenitev. Nepotrebno bi bilo vklopiti še eno stopnjo kompresorjev, če je zaznavalo sesalnega tlaka zaznalo upad višanja sesalnega tlaka. V tem primeru izvedemo upočasnitev programa NAPREJ tako, da postavimo časovne zakasnitve med stopnjami na vrednost nič ([5]). Zaradi tega se podaljša čas med stopnjami. Časi do vklopa stopenj, ki še niso vklopljene od takrat, ko se je naraščanje tlaka za trenutek ustavilo, se tako podaljšajo.

Podobno se dogaja pri programu kompresorjev NAZAJ. Pogoji za izklop stopenj je program kompresorjev NAZAJ in iztek časovnih zakasnitev posameznih stopenj. V primeru, da se med programom kompresorjev NAZAJ začne naraščati sesalni tlak, se časi med stopnjami postavijo na nič, kar pomeni, da se odziv krmilja upočasni.

Opisano lahko prikažemo tudi z uporabo časovnih diagramov, kar je razvidno s slike 8 [7].

Z navedenim krmiljenjem stopenj kompresorjev dosežemo, da se stopnje kompresorjev po nepotrebem ne vklopijo oziroma izklopijo. Na ta način se preveliko zviševanje oziroma zniževanje sesalnega tlaka umiri, kar pa pomeni manjše nihanje krivulje med točkama 4 in 1 v diagramu T-S s slike 7. Manjše nihanje omenjene krivulje vsekakor pomeni izboljšanje hladilnega števila.

2.5 Vzdrževanje temperature v komorah pri neposrednih hladilnih sistemih

Povprečno temperaturo v komori krmilje ves čas primerja z zeleno in po potrebi vklopi ventilatorje ter polnilni ventil uparjalnika. Želena

suction pressure is not always constant; although it is however, near the set point. According to Figure 7, this means that there is no straight line between points 4 and 1, there is an irregular shape instead, which depends on the suction pressure oscillation. The shape of the suction-pressure-change is a curve, which depends on the number of activated evaporators in the individual rooms and their heat removal. Preserving the suction pressure as high and as constant as possible, the COP can be increased. This research is an attempt to look for ways to improve the control of the reciprocating compressors that are bound in the multiplex system.

In order to improve the control of the compressor, we focus on preserving the suction pressure even more precisely than it was done in the previous section.

By decelerating the described transient response of the control system we can achieve a higher precision in preserving the suction pressure at a constant level. This is the idea of the slower response. The processor monitors the rising or falling speed of the suction pressure as it changes. Providing there are enough stages active for the present load of the system, the processor perceives a fall of the pressure in the forward program. Providing the suction pressure probe perceives a slowing rise of the suction pressure, it is unnecessary to activate another stage of the compressors. In this case we execute the deceleration of the forward program, so that we set the time delays between stages to zero ([5]). Consequently, the time periods between the stages are extended. The time periods to the activation of the stages that have been idle from the time the pressure increasing stopped for a while, are extended.

A similar process takes place in the backward program. The requirements for deactivating the stages are the compressor program backward and the delay of the stages being completed. In the event that the rising of the suction pressure takes place during the backward program, the time periods between the stages are set to zero, which means the reaction of the control system is decelerated.

This is presented in more detail in the time diagrams in Figure 8 [7].

With this kind of compressor stage control, we achieve stages that are not activated or deactivated unnecessarily. A too frequent increase or decrease of the suction pressure becomes less frequent and, consequently, the oscillation of the curve between points 4 and 1 in the T-S diagram (Figure 7) is reduced. Of course, a reduced oscillation of the curve means an improvement in the COP.

2.5 Temperature control in a direct refrigeration system

The controller constantly compares the average temperature to the required temperature and activates the fans and the expansion valve of the

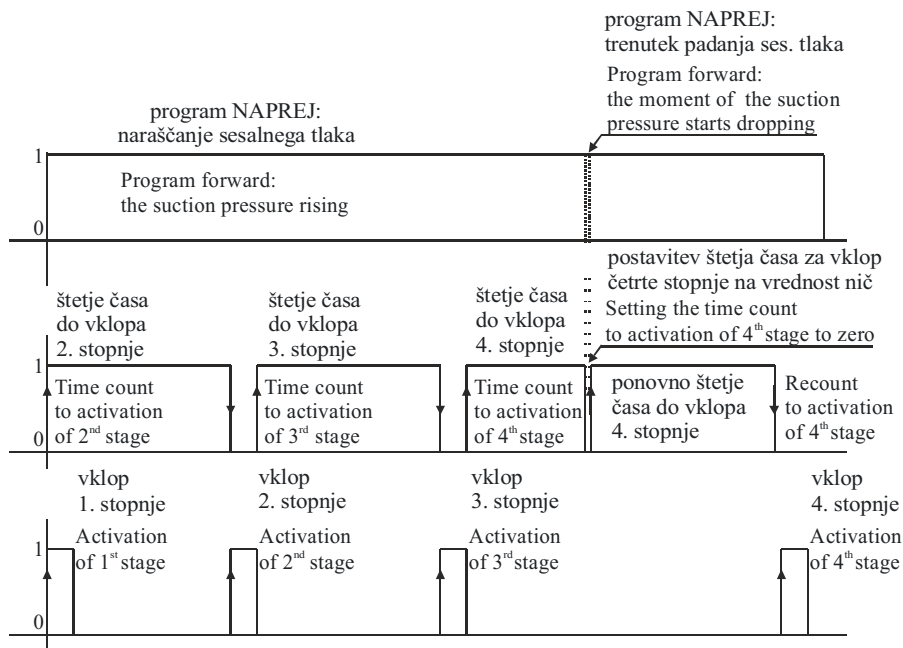

Sl. 8. Upočasnitev vklopa stopenj kompresorjev v primeru nižanja sesalnega tlaka pri programu NAPREJ
 Fig. 8. Deceleration of compressor stages in the event of the dropping of suction pressure in program forward

vrednost temperature smo v obravnavanem primeru označili z oznako SET, razliko med preklopi pa z oznako DIF. V primeru, da se povprečna temperatura poveča nad vrednost $SET + DIF$, se vključi hlajenje komore in ostane vklopljeno, dokler se povprečna temperatura ne zmanjša na ali pod vrednost SET. V primeru, da bi za vzdrževanje temperature v komori potrebovali tudi grelnike, bi se le-ti vklopili pri zmanjšanju povprečne temperature pod vrednost $SET - DIF$, vključeni pa bi ostali do vrednosti SET.

2.6 Odtaljevanje uparjalnika pri neposrednih hladilnih sistemih

Odtaljevanje je pri hladilnih komorah zelo pomemben postopek, ki v osnovi ne pripomore k hlajenju komore, ampak celo povečuje toplotne dobitke, saj pri postopku odtaljevanja z grelniki vnašamo toploto v notranjost komore in tudi ustavljamo postopek hlajenja. Ne glede na to je odtaljevanje postopek, ki je nujno potreben. Na lamelah uparjalnika v komori se pri postopku hlajenja nabira srež. Če pravočasno ne poskrbimo za njegovo odstranitev, se sreža nabere toliko, da je pretok zraka med lamelami zelo oviran, lahko pa tudi onemogočen. V takšnem primeru uparjalnik ne more več opravljati naloge hlajenja. Za odtaljevanje hladiv v hladilnih komorah uporabljamo odtaljevanja z grelniki, zrakom, vodo ali vročim plinom. Ne glede na način odtaljevanja veljajo pri krmiljenju odtaljevanja splošna načela, ki so opisana v nadaljevanju.

evaporator, if necessary. In the case that we are dealing with, the required temperature is defined by SET and the difference between shifts by DIF. Providing the average temperature rises above $SET + DIF$, the cooling of the chamber is activated and is in operation until the average temperature drops to, or under, the SET value. Providing we require heaters for heating in order to preserve the temperature in the chamber, they are activated after the average temperature drops below the $SET - DIF$ value, and continue to operate until the temperature reaches the SET value.

2.6 Defrosting process in a direct refrigeration system

The defrosting process is a very important process in the refrigeration of cold stores. Basically, it does not contribute to the refrigeration of the chamber, it even increases the heat loss, because in the process of defrosting with heaters, we bring the heat into the chamber and interrupt the refrigeration. Despite this fact, the defrosting process is inevitable. Ice and hoar frost appear on the surface of the fins of the cooler during this process. Unless we remove them, they become so large that they obstructs the air flow through the fins. In this case the cooler can no longer perform its function. To remove the hoar frost from the coolers, we do the defrosting using heaters, air, water, or hot gas. No matter what method we choose, there are certain principles to be followed during defrosting control.

Prvi korak pri odtaljevanju je tako imenovani ČAS MED ODTALJEVANJI. To ni dejanski čas, temveč čas dejanskega hlajenja, ki mora preteči od prenehanja nekega odtaljevanja do naslednje sprožitve odtaljevanja. Uporabnik ta čas nastavlja med vrednostjo treh do osem ur. Izbira je odvisna predvsem od namembnosti komore. V primeru, da uporabnik pogosto odpira vrata komore in vnaša blago z večjo relativno vlago, temperatura uparjanja ali hladilne mešanice na hladivu pa je dovolj nizka, je potreba po odtaljevanju pogostejša.

Naslednji korak, ki prične teči, ko pride do postopka odtaljevanja (preteku časa med odtaljevanji), je ČAS ODTALJEVANJA. V tem času poteka odtaljevanje uparjalnika. Ventilatorji mirujejo, delujejo pa grelniki ali ventil vročega plina. Ta korak se konča, ko temperatura v uparjalniku doseže dovolj visoko vrednost (med 4 °C in 10 °C). Ta vrednost je določena s parametrom TEMPERATURA IZKLOPA ODTALJEVANJA.

Če v nastavljenem času odtaljevanja temperatura na hladilniku ne bi dosegla omenjene vrednosti, bi se korak končal po preteku časa odtaljevanja. Koraku odtaljevanja sledi korak ODCEJANJA. V tem koraku mirujejo vsi električni elementi. V tem času se kapljice vode iz lamel uparjalnika odcedijo v kad oziroma odtok. Naslednji korak je ZAKASNITEV VENTILATORJEV. Če bi takoj po odcejanju vklopili ventilatorje uparjalnika, bi to povzročilo razpršenje preostalih kapljic, ki se jim ni uspelo odcediti iz lamel, v prostor. Za preprečitev tega je treba najprej vklopiti hlajenje (polnilni ventil), šele po nastavljenem času pa se vklopijo ventilatorji. Tako preostale kapljice zamrznejo na lamelah in jih ventilatorji ne morejo razpršiti v prostor.

The first step is the so-called TIME PERIOD BETWEEN DEFROSTING ACTS. This is not the actual time but a time of effective cooling, which is supposed to pass until the end of a certain defrosting act and to the next activation of defrosting. The user may set the time value at three to eight hours. The choice depends on what the chamber is used for. The defrosting is required more frequently when the user frequently opens the doors and brings in goods with a higher relative moisture, and the temperature of the evaporation or the cooling mixture on the cooler is low enough.

The next step is activated after the time period of the defrosting has passed. This step is called TIME PERIOD OF THE DEFROSTING ACT. At this point the defrosting of the cooler takes place. The fans are idle but the heaters or the hot-gas valve is activated. The step ends when the temperature in the cooler reaches a high enough value (between 4 and 10°C). This value is defined by a parameter THE TEMPERATURE ENDING THE DEFROSTING ACT.

If the temperature of the cooler does not reach the value mentioned in the set period of time, this step is finished after the defrosting time has passed. The DRIPPING step follows. Now all the elements are idle. In this time, the water drops drip from the fins of the cooler into the tray or the outlet. The step that follows is THE FAN DELAY. Activating the fans of the cooler immediately after the dripping would cause spraying about the remaining drops of water, which have not managed to drip out of the fins. To prevent that from happening it is necessary to activate the cooling (expansion valve) first, and only after the set time the fans can be activated. Now the drops freeze on the surface of the fins and cannot be sprayed about by the fans.

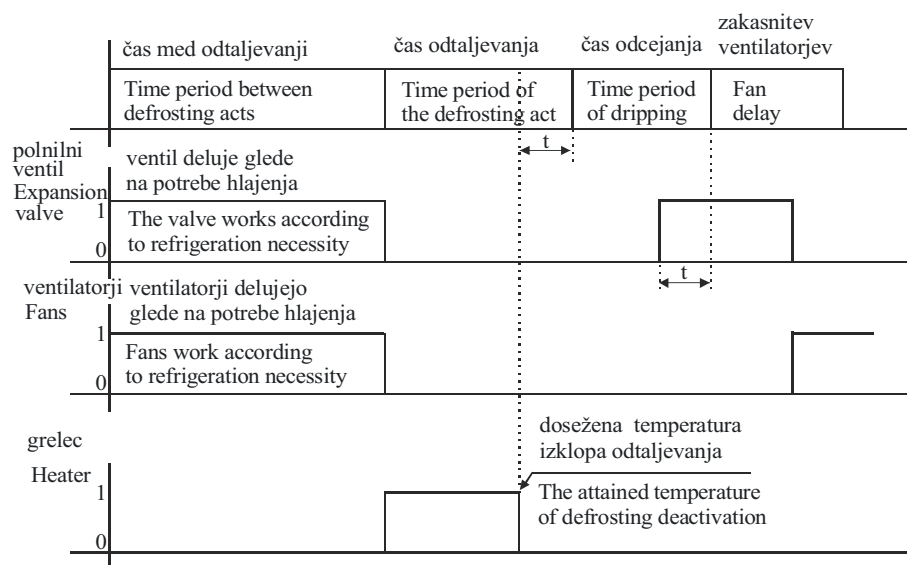

Sl. 9. Odtaljevanje hladilnika z upoštevanjem celotnega časa postopka odtaljevanja
Fig. 9. Defrosting the cooler in terms of the total time of the defrosting process

S končanjem koraka ZAKASNITEV VENTILATORJEV se vrnemo na prvi korak, imenovan ČAS MED ODTALJEVANJI. Tako se postopki ponavljajo. Na sliki 9 so prikazani koraki odtaljevanja v časovnem diagramu.

2.7 Vzdrževanje temperature v komorah pri posrednih hladilnih sistemih

Tako kakor pri neposrednih hladilnih sistemih tudi pri posrednih merimo temperaturo ali povprečne temperatur v komori. Glede na izmerjeno in dejansko temperaturo v komori se vključujejo in izključujejo ventilatorji hladilnika. Podobno vlogo kakršno ima pri neposrednih sistemih polnilni ventil, ima pri posrednih sistemih črpalka in tripotni ventil hladilne mešanice na vstopu v hladilnik.

Bistvena prednost posrednega hladilnega sistema pred neposrednim je ta, da lahko z uporabo zveznega pogona motornega ventila in proporcionalno integracijsko diferencialnega (PID) krmilnika, dosegamo poljubno vrednost temperature na lamelah hladilnika in s tem temperaturo izpihanega zraka. Tako lahko pri določenih vrstah živil (npr. skladiščenje jabolk) dosežemo manjši odvzem vlage.

Temperaturno zaznavalo meri temperaturo hladilne mešanice na izstopu iz tripotnega ventila. Ta je pri normalnem delovanju oziroma v primeru hlajenja in delovanja črpalke praktično tudi temperatura lamel hladilnika. S primerjavo želene temperature hladilne mešanice v hladilniku z dejansko izmerjeno vpliva PID krmilnik na lego tripotnega ventila. Črpalka deluje ves čas hlajenja, prav tako tudi ventilatorji hladilnika.

Po dosegu želene temperature prostora se izklopijo ventilatorji hladilnika ter črpalka hladilne mešanice. Lego ventila je v času, ko ni potrebe po hlajenju, bolje obdržati v takšni legi, v kakršni je bil v

As THE FAN DELAY is completed, we return to step one, the TIME PERIOD BETWEEN THE DEFROSTING ACTS. The steps are being repeated constantly. Figure 9 shows these steps in a time diagram.

2.7 Temperature control in an indirect refrigeration system

The temperature or the average temperature inside the chamber is measured in direct systems as well as in indirect refrigeration systems. The fans in the chamber are activated and deactivated according to the measured and the actual temperatures. In the indirect system, the pump and the three-way valve of the cooling mixture at the entrance of the cooler have a similar function to that of the expansion valve in the direct system.

The advantage of the indirect system is that we can achieve any temperature value in the coil of the cooler, and therefore the temperature of the blown out air, by using a valve with a proportional actuator and PID controller. Consequently, we can achieve a lesser removal of the moisture from a certain type of food (i.e., apple storage).

The temperature probe measures the temperature of the cooling mixture on the exit of the three-way valve. The temperature, in the normal state or in cooling and pump activation, is the same as the temperature of the coil of the cooler. The PID controller influences the position of the three-way valve by comparing the required temperature of the cooling mixture in the cooler to the measured temperature. The pump and the fans of the cooler are active during the whole time period of the cooling process.

As the required temperature is attained, the fans of the cooler and the pump of the cooling mixture are shut off. During these times the refrigeration is unnecessary, it is better to preserve the position of the

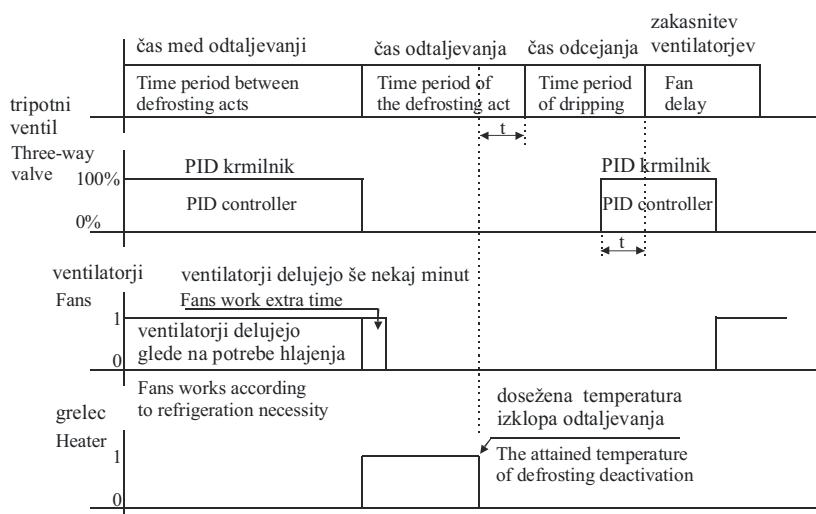

Sl. 10. Odtaljevanje hladilnika pri posrednem sistemu
Fig. 10. Defrosting the cooler in an indirect system

trenutku prenehanja hlajenja. Tako bo ob ponovni potrebi po hlajenju ventil hitreje dosegel lego, ki je potrebna za doseganje želene temperature hladilne mešanice.

2.8 Odtaljevanje hladilnikov pri posrednih hladilnih sistemih

Kakor je bilo že poprej navedeno, je sredstvo, ki se pri posrednih hladilnih sistemih pretaka skozi hladivo zraka, ledna voda ali glikol. Količina vode oziroma glikola, ki je v nekem trenutku v hladilniku zraka, ima večjo toplotno zmogljivost pri segrevanju oziroma shlajevanju kakor na primer freon, ki se pri neposrednih sistemih uparja v hladivu. Zaradi navedenega učinka je treba pri odtaljevanju hladiva upoštevati določene posebnosti, ki se razlikujejo od odtaljevanja uparjalnikov pri neposrednih sistemih.

Pred začetkom odtaljevanja hladilnika je treba najprej popolnoma zapreti tripotni ventil hladilne mešanice. Črpalka naj deluje nepretrgano naprej. Ventilatorji hladiva naj še nekaj minut delujejo, da tako še nekoliko ohladijo prostor, kajti akumulacija hladu je v hladilniku nezanimljiva. Čas, ki ga navajamo kot nekaj minut, je odvisen predvsem od velikosti hladiva, običajno pa je ta vrednost štiri minute.

Po preteku tega časa naj se ventilatorji izklopijo, vklopi pa naj se grelnik za odtaljevanje. Od tu dalje je postopek povsem podoben odtaljevanju pri neposrednih sistemih, le da nalogo termostata, ki izklopi grelnike, nadomešča kar temperaturno zaznavalo hladilne mešanice, ki je v fazi hlajenja rabilo kot krmiljena veličina.

3 SKLEP

Ne glede na to, ali imamo neposreden ali posreden hladilni sistem, je izbira med klasičnim in prostoprogramljivim mikropostopkorskim krmiljenjem odvisna od zapletenosti hladilnega sistema ter od tehnoloških zahtev hladilne komore. Če imamo velike zahteve glede nadzora nad krmiljenjem hladilnih naprav v hladilni komori, je uporaba prostoprogramljivih krmilnih sistemov neizogibna. Enako velja tudi v primeru zapletenega sistema na ravni kompresorskega agregata.

V prispevku želimo poudariti, da je v primeru prostoprogramljivih krmiljenj vredno izdelati krmilje, ki izboljšuje učinkovitost hladilnega sistema ter večje udobje pri nadzoru elementov hladilne komore. Analogno obravnavani nalogi bi podobno lahko obravnavali tudi preostala področja hladilništva.

4 LITERATURA 4 REFERENCES

- [1] ASHRAE (American Society of Heating, Refrigerating and Air-Conditioning Engineers): *Handbook - Fundamentals*, Atlanta, 1997, Chapter 1: Thermodynamics and refrigeration cycles, 12-19
- [2] Vujić, S. (1983) Rashladni uređaji. Mašinski fakultet, Beograd, 109-118
- [3] Kladnik, R. (1989) Visokošolska fizika 1. del, DZS, Ljubljana, 210-215

valve from the moment the cooling was stopped. Thus, in the case of restarting the refrigeration, the valve will be able to immediately reach the required position needed to attain the required temperature of the cooling mixture.

2.8 Defrosting process in an indirect refrigeration system

As already stated, the medium that flows through the air cooler is water or glycol. The amount of water or glycol that is in the air cooler at a certain moment has a higher persistency when being heated or refrigerated than, for example, freon, which transforms itself into a vapor in the cooler. Because of this effect, it is important to consider certain particularities, which differ from those in the direct system defrosting.

It is crucial to shut off the three-way valve completely before starting the defrosting of the cooler. The cold in the cooler is not to be ignored, therefore, the fans should continue to work in order to cool the air even more. The time depends on the size of the cooler, but it usually takes four minutes.

As the above time period passes, the fans should be shut off and the heater should be activated for defrosting. From this point onwards, the procedure resembles the defrosting in direct systems, with one difference. The thermostat that shuts off the heaters is replaced by the temperature probe of the cooling mixture.

3 CONCLUSION

A direct or an indirect refrigeration system, the choice between classical and microprocessor control, depends on the complexity of the cooling system and the technological requirements of the cold store. Assuming we have high-quality requirements for controlling the cooling machines in the cold store, choosing microprocessor control is inevitable. The same goes for the complex system at a level of the compression aggregate.

In this paper we have tried to emphasize that it pays to choose a form of control that results in an improvement in the refrigeration system and offers more comfort in supervising the elements in the cold store.

- [4] ASHRAE (American Society of Heating, Refrigerating and air-conditioning engineers): *Handbook - Refrigeration, Atlanta*, 1998, Chapter 4: Secondary coolants in refrigeration systems, 1-6
- [5] OMRON: SYSMAC Program C200H operation manual, 1992, 159-163
- [6] Avtomatika Metronik: Revija o avtomatizaciji procesov, Ljubljana, oktober 1999, Trendi v razvoju SCADA sistemov, 7-9
- [7] Cajhen, R. (1990) Pomnilniško programljivi krmilni sistemi, Univerza v Ljubljani, 54-55
- [8] <http://www.ikk-online.com/main/d9v18zx1/d9v1ly3l/d9v6pe27/page.html>

Naslov avtorjev: Janez Primožič
prof.dr. Rajko Svečko
Univerza v Mariboru
Smetanova 17
2000 Maribor
rajko.svecko@uni-mb.si

Authors' Address: Janez Primožič
Prof.Dr. Rajko Svečko
University of Maribor
Smetanova 17
2000 Maribor, Slovenia
rajko.svecko@uni-mb.si

Prejeto: 16.10.2003
Received:

Sprejeto: 8.4.2004
Accepted:

Odprto za diskusijo: 1 leto
Open for discussion: 1 year