

## Pregled brušenja z velikimi hitrostmi in učinkovitih abrazivnih orodij

### A Review of High-Speed Grinding and High-Performance Abrasive Tools

Peter Krajnik - Janez Kopač

*Prispevek se nanaša na pregled sodobnih vidikov brušenja glede na zahteve po povečani produktivnosti in kakovosti obdelave. Predstavljen je osnovni mehanizem brušenja in uporabe, ki se nanašajo na najnovejšo tehnologijo brušenja z velikimi hitrostmi (BVH) z zelo učinkovitimi orodji. Z napredkom tehnologije BVH je treba zahtevam obdelave z velikimi hitrostmi prilagoditi tudi obdelovalni stroj, sistem za hlajenje in nadzor postopka. Nadalje je v manjšem obsegu obravnavana še celovitost brušene površine in proizvodna ekonomika BVH.*

© 2004 Strojniški vestnik. Vse pravice pridržane.

**(Ključne besede: brušenje zelo hitro, abrazivi, integriteta površin)**

*This paper reviews the modern aspects of grinding with regards to enhanced productivity and manufacturing quality demands. The basic mechanism of grinding and the applications for the state-of-the-art technology of high-speed grinding (HSG) with high-performance grinding wheels are presented. In addition to the improvements in the technology associated with HSG, the grinding machine-tool, the coolant system and the process monitoring also need to adapt to high-speed machining. In addition, the ground-surface integrity and the economic efficiency of HSG are also briefly discussed.*

© 2004 Journal of Mechanical Engineering. All rights reserved.

**(Keywords: high speed grinding, abrasives, surface integrity)**

#### 0 UVOD

Povečevanje zahtev po zelo kakovostnih in robustnih proizvodih, predvsem v avtomobilski industriji, proizvodnji turbin in ležajev, terjajo nove in izboljšane postopke brušenja, ki zagotavljajo najboljše učinke glede na produktivnost in natančnost ob sprejemljivih stroških. Povečanje postopkovne učinkovitosti ob zmanjšanju stroškov je bilo v zadnjih letih doseženo z izrabo prednosti brušenja z velikimi hitrostmi, ki uporablja najnovejše abrazive, veziva z izboljšano obrabno odpornostjo in ustrezne stroje. Izbira ustreznega postopka je odvisna od koncepta obdelovalnega stroja, uporabe različnih abrazivnih orodij in okvira krmiljenja parametrov postopka.

Uporabe BVH so razširile področje brušenja od tradicionalnih končnih obdelovalnih postopkov do zelo učinkovitih natančnih obdelav. Postopkovni razvoj je pripeljal do novega primera brušenja, ki se nanaša na konfiguracijo izboljšane postopka z zelo učinkovitimi zmožnostmi [1].

Dandanes, ko je kakovost obdelovalnih postopkov z velikimi hitrostmi prav tako pomembna

#### 0 INTRODUCTION

Increasing demands for high-quality and robust products, particularly in the automotive, turbine and bearing industries, require new and improved grinding processes that provide the best performance with respect to productivity and precision at a reasonable cost. Increased manufacturing performance and reduced costs have both been achieved in recent years through the exploitation of advances in high-speed grinding (HSG), which utilizes the latest abrasives, bonding systems with improved wear resistance, and appropriate machine-tools. The selection of an effective procedure is dependent on the machine-tool concept, the employment of different abrasive tools and a frame of process parameters' manipulation.

Applications of HSG have expanded the field of grinding from the traditional finish machining process to high-performance precision machining. Process development has led to a new grinding paradigm, which refers to the configuration of an improved process with high-performance capabilities [1].

Nowadays, when the quality in high-speed machining processes is just as important as the effi-

kakor njihova učinkovitost, morajo biti postopki brušenja predrugačeni. Ekonomična in učinkovita izraba BVH je omejena na zožen postopkovni okvir, ki omogoča optimalno gospodarnost. Primerno BVH lahko dosežemo le z učinkovito integracijo upravljanja kakovosti ([2] in [3]), ki se nanaša na neposreden sistem nadzora postopka, večnivojsko nadzorovanje napak, vizualizacijo, neposredne/posredne meritve, prilagodljivo krmiljenje in diagnozo kakovosti na daljavo. Široki vidiki integracije upravljanja kakovosti presega okvir tega prispevka.

Cilj tega prispevka se nanaša na pregled osnovnih vidikov brušenja s poudarkom na primerih sodobnega BVH težko obdelovalnih kovinskih materialov z orodji iz zelo učinkovitih abrazivov.

## 1 OSNOVE BRUŠENJA IN ODREZOVALNO NAČELO

Brušenje je postopek odrezovanja, ki se nanaša na obdelavo z geometrijsko nedefiniranimi rezalnimi robovi. Mehanizem brušenja predstavlja zapleteni postopek odvzema materiala, ki vključuje brus s popolnoma naključno strukturirano topografijo in zrno z običajno negativnim kotom cepilne ploskve (sl. 1a).

Brušenje se nanaša na odvzem materiala posameznih zrn, katerih rezalni rob je omejen s silo in tirnico. Začetek odrezovanja karakterizira elastična deformacija, kateri sledi plastično tečenje materiala obdelovanca (sl. 1b). Nastanek odrezka se začne v točki, kjer se debelina odrezka ujema z globino rezanja. Na nastajanje odrezka bistveno vplivajo pogoji trenja, lastnosti tečenja materiala obdelovanca in rezalna hitrost. Dosleden opis mehanizma odrezovanja torej vključuje zapletene zveze prodiranja med dvema trdima materialoma, elasto-plastno mehaniko in tribološke vidike, ki vplivajo na odrezovalno kinematiko in dotikalne pogoje.

ciency, grinding processes have to be redesigned. The economic and effective employment of HSG is limited to a narrow machining frame, which leads to optimum cost efficiency. Adequate HSG is only achieved by effective quality-management integration ([2] and [3]), which refers to an online process monitoring system, multilevel error control, visualisation, in/post process measurements, adaptive control and remote quality diagnosis. The broad aspects of integrated quality management are beyond the scope of this paper.

The objectives of this paper are therefore to review the basic aspects of grinding and to point out the paradigms of the modern HSG of hard-to-machine ferrous materials with high-performance abrasives.

## 1 FUNDAMENTALS OF THE GRINDING AND CUTTING PRINCIPLE

Grinding is a machining cutting operation that refers to machining with geometrically undefined cutting edges. The mechanism of the grinding process is a complex material-removal process, including a grinding wheel with a perfectly randomly structured topography and a grain with a generally negative rake angle (Figure 1a).

Grinding refers to material removal by individual grains whose cutting edge is bounded by force and path. The initial cutting interface is characterized by elastic deformation, which is followed by plastic flow of the workpiece material (Figure 1b). The chip formation initiates at a point where the chip thickness corresponds to the cutting depth. The interface friction conditions, the flow characteristics of the material and the cutting speed have a significant influence on chip formation. A consistent cutting-mechanism description therefore comprises complex penetration relationships between two hard materials, elasto-plastics mechanics and aspects of tribology, which all influence the kinematics and contact condition.

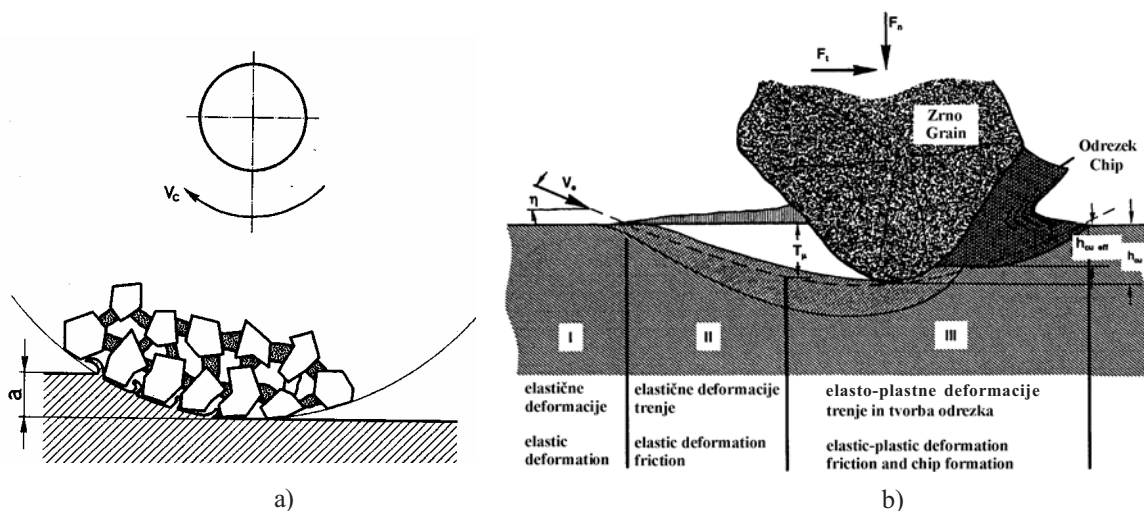

Sl. 1. Makro in mikro načelo brušenja ([5] in [6])  
Fig. 1. Macro and micro grinding principle ([5] and [6])

Porabljeno delo za nastanek odrezka je zmnožek mehanske moči in časa brušenja. Pri brušenju mehanska moč pomeni moč za brušenje, ki je zmnožek obodne rezalne sile in rezalne hitrosti. Večina dela za nastanek odrezka se spreminja v termično energijo, tj. toploto, ki se porazdeli v obdelovanec, brus, odrezke, hladilno-mazalno sredstvo in okolico.

## 2 ZELO UČINKOVITI ABRAZIVI

Bistvene prednosti povečane produktivnosti pri brušenju z velikimi hitrostmi se nanašajo na povečano obstojnost zelo učinkovitih brusov. Zahteve za ta orodja se nanašajo na njihovo dopustno vrtilno hitrost in odpornost proti obrabi in lomu. Poleg tega so zaželeni še dobre značilnosti dušenja, velika togost in ustrezna toplotna prevodnost [1]. To poglavje se nanaša na BVH jekel z uporabo brusov iz:

- kubičnega borovega nitrida (KBN)
- mikrokristalinskega aluminijevega oksida ( $Al_2O_3$ )

### 2.1 Abrazivi CBN

Zaradi visoke trdote, termične in kemične odpornosti je KBN idealen zelo učinkovit abraziv. V primerjavi z običajnimi abrazivi ima KBN najmanjšo obrabo in zaradi tega stabilno rezalno zmogljivost v daljšem časovnem obdobju. Prednosti se zlasti nanašajo na brušenje težko obdelovalnih legiranih jekel s trdoto nad 55 HRC, npr. hitrorezna in kromova jekla. Posamezno zrno KBN (sl. 2) je trdo in ima veliko toplotno prevodnost ter v primerjavi z običajnim zrnom stokrat večjo obstojnost. Zaradi inherentne ostrine omogočajo hladnejšo obdelavo in zagotavljajo veliko celovitost obdelane površine z manjšo hrapavostjo [4].

Brusi KBN se običajno sestojijo iz aluminijastega, jeklenega, keramičnega, smolnatega nosilnega telesa in tankega brusilnega sloja. Brusne značilnosti brusov KBN določajo karakteristike zrna, njihov tip, koncentracija in vezivo. Omogočene so rezalne hitrosti do 280 m/s.

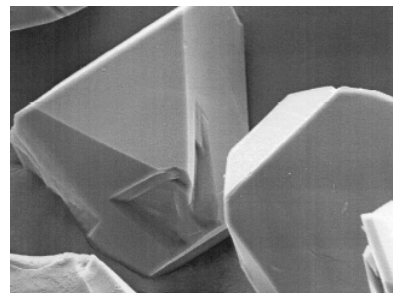
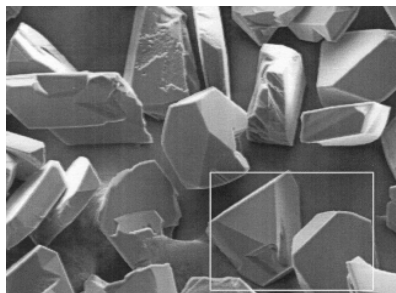
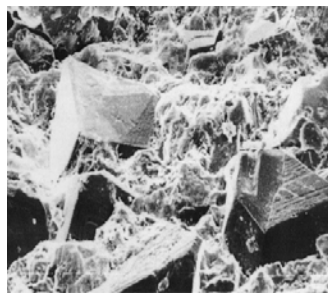

Sl. 2. Mikrostruktura KBN [1]  
Fig. 2. CBN microstructure [1]

The work performed during chip formation is the product of the mechanical power input and the grinding time. In grinding, mechanical power refers to the grinding power, which results from the product of the tangential cutting force and the cutting speed. The work for chip formation is mainly transformed into thermal energy, i.e., heat, which is distributed to the workpiece, grinding wheel, chips, coolant and the surroundings.

## 2 HIGH-PERFORMANCE ABRASIVES

The important advantage of increased productivity during grinding at high cutting speeds is the increased tool life of high-performance grinding wheels. The grinding tools for HSG are subjected to special requirements in terms of their allowed rotational speed and resistance to wear and fracture. Good damping characteristics, high rigidity, and adequate thermal conductivity are also desirable [1]. This section refers to the HSG of steels with grinding wheels of:

- Cubic boron nitride (CBN)
- Microcrystalline aluminium oxide ( $Al_2O_3$ )

### 2.1 CBN abrasives

Because of its high level of hardness, its thermal and chemical resistance, CBN is a perfectly suited high-performance abrasive. Compared with conventional abrasives, CBN has minimal wear and therefore its cutting ability is stable over a longer period of time. In addition, it offers advantages, especially in the grinding of hard-to-machine steels with large proportions of alloy and hardnesses of 55 HRC and above, e.g., high-speed steels and chrome steels. An individual CBN grain (figure 2) is hard and has a high thermal conductivity and will therefore have a life that is a hundred times that of a conventional grain. Because of its inherent sharpness, CBN tends to machine cooler, providing a high surface integrity and a superior surface finish [4].

CBN grinding wheels generally consist of an aluminium, steel, ceramic or artificial resin base and a thin grinding layer. The grinding characteristics of a CBN grinding wheel are determined by the grain characteristics, the type of grain, its concentration and the bonding system. Cutting speeds of 280 m/s are possi-

Sodobna večplastna veziva za bruse KBN vključujejo kovinsko sintrana in keramična veziva, velike trdote in odpornosti proti obrabi. Poravnava takšnih orodij je težavna glede na njihovo veliko trdnost. Prednosti brusov KBN je povezana z visoko ceno.

## 2.2 Mikrokristalinski aluminijev oksid (sintrani korund $Al_2O_3$ )

V nasprotju z dragim brušenjem s KBN so različni proizvajalci orodij nedavno ponudili orodja, ki integrirajo običajne abrazive, ki omogočajo večjo stopnjo odvzema materiala pri velikih hitrostih. Keramično vezani brusi omogočajo ekonomske prednosti kakor tudi odlično učinkovitost orodja velike poroznosti, čigar odprta struktura omogoča samoostrenje. Orodja iz sintranega korunda omogočajo BVH do rezalnih hitrosti 180 m/s. Zaradi njegove zmogljivosti in osnovnih značilnosti zapira vrzel med zelo trdimi superabrazivi (diamant in KBN) ter običajnimi brusnimi abrazivi. Sintrani korund združuje lastnosti keramike (K) in zlitega aluminijevega oksida (S) v keramično vezanem brusu za BVH [4]. Ta kombinacija (sl. 3a) omogoča agresivno odrezovanje, dobro stabilnost oblike in veliko obstojnost.

Običajni korund določajo prednostne makrolomne ploskve (sl. 3b), iz katerih se krhajo razmeroma veliki delci. Zaradi mikrokristalinske strukture (0,5  $\mu m$ ) sintranega korunda ta nima prednostnih lomnih površin (slika 3c), zato so odlomljeni delci razmeroma majhni, s čimer zrna obdržijo svojo ostrino [6]. Sintrani korund je sorazmerno poceni abraziv, ki se je cenovno uvrstil med običajne in zelo drage abrazive KBN z merljivimi izboljšavami brušenja za faktor tri do pet [4].

Nova generacija brusov s skrajno velikimi hitrostmi (rezalne hitrosti do 500 m/s) se nanaša na keramično vezan brus KBN s plastičnim nosilnim telesom, ki je ojačan z ogljikovimi vlakni [9]. Zahteve

ble. Modern multi-layer bonding systems for CBN grinding wheels include sintered metal bonds and vitrified bonds, which possess a high bond hardness and wear resistance. The dressing of these tools is difficult because of their high mechanical strength. However, the performance of CBN wheels comes at a price.

## 2.2 Microcrystalline Aluminium Oxide (sintered corundum $Al_2O_3$ )

To compete with to CBN grinding, various grinding-tools manufacturers have recently launched grinding tools that integrate conventional abrasives for a higher MRR at high cutting speeds. Vitrified bonded wheels offer not only economic advantages but also the excellent performance of a highly porous tool, whose open structure enables self-sharpening. Sintered corundum tools offer HSG up to cutting speeds of 180 m/s. Because of their characteristics and efficiency they are closing the gap between the very hard superabrasives (diamond and CBN) and the conventional grinding abrasives. Sintered corundum combines the properties of the ceramic (K) and fused aluminium oxide (S) into vitrified grinding wheels [7]. This combination (Figure 3a) exhibits a high level of sharpness, aggressive cutting, good form holding and a long life.

Conventional corundum has preferential macro fracture planes (Figure 3b), from which relatively large particles chip away. Because of its microcrystalline structure (0.5  $\mu m$ ), sintered corundum does not have preferential fracture planes (Figure 3c), hence the particles that chip away are relatively small and the grains retain their sharpness [6]. Aluminium oxide is a relatively low-cost abrasive, which has positioned itself in economic terms between the conventional and the very expensive CBN abrasives, with measurable improvements in grinding by a factor of three to five times [4].

The new generation of ultra-high-speed grinding wheels (cutting speeds up to 500 m/s) consist of a vitrified CBN wheel with a CFRP (carbon-fibre-reinforced plastics) core [9]. The requirements for such

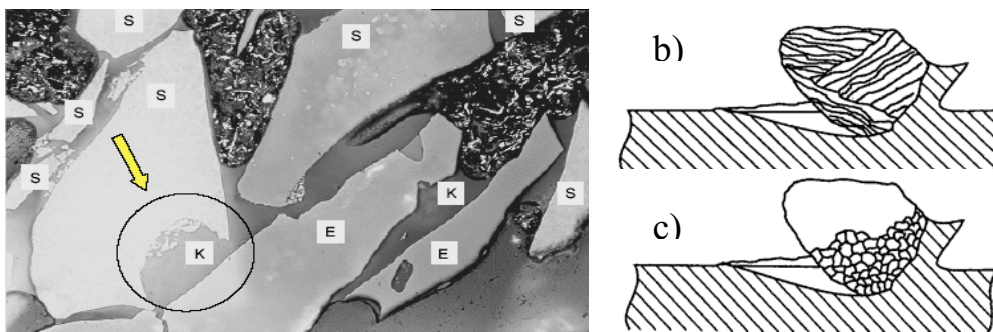

Sl. 3. Mikrostruktura sintranega korunda ([7] in [6])

Fig. 3. Sintered corundum microstructure ([7] and [6])



teh brusov se nanašajo na zelo veliko trdnost nosilnega telesa z majhnimi radialnimi raztezki, kvaziizotropične značilnosti materiala, majhno težo in dobre lastnosti dušenja.

### 3 BRUŠENJE Z VELIKIMI HITROSTMI

BVH opredeljuje težnja po izboljšanju ekonomike postopka s povečanjem stopnje odvzema materiala ob hkratnem izboljšanju stabilnosti in zmožnosti postopka ter kakovosti obdelave. V tem pomenu je povečanje rezalne hitrosti prvi pogoj za povečanje produktivnosti.

V tehnološkem načelu se BVH nanaša bodisi na:

- zelo učinkovito brušenje v smislu zmanjšanja časa obdelave, pri čemer je kakovost obdelave nespremenjena;
- zelo kakovostno brušenje za doseganje velike kakovosti obdelave pri stalni ravni obdelovalne zmogljivosti.

Postopek brušenja je zaradi kompleksnosti zelo težaven za analizo. Običajno se tehnološke študije postopka brušenja nanašajo na model, ki je veljaven le v omejenem področju z danimi robnimi pogoji. Model na osnovi vstopnih veličin omogoča simuliranje izstopnih veličin in je tako lahko namenjen za ocenitev postopkovnih učinkov [8]. Poenostavljena primerjava med različnimi postopki BVH lahko temelji na primerjavi različnih parametrov, ki se nanašajo na vstopne, postopkovne in izstopne veličine. Postopkovna razmerja so lahko povzeta grafično (sl. 4).

wheels include a very high core-material strength with a small radial expansion, quasi-isotropic material characteristics, low weight and good damping properties.

### 3 HIGH-SPEED GRINDING PROCESS

HSG is characterised by efforts to improve the economics of the process by increasing material removal rates (MRR) and simultaneous improvements of process stability, capability and machining quality. In this way, an increased cutting speed is a prerequisite for increased productivity.

In technological terms HSG refers to either:

- High-performance grinding in order to reduce the machining time while maintaining the same level of quality.
- High-quality grinding in order to enhance machining quality while maintaining a constant machining capacity.

The grinding process is very difficult to analyse due to its inherent complexity. Usually, a technological study of a grinding process refers to a model that is valid in only a limited field within given boundary conditions. A model can be used to predict process output and thus establish a relation between input and output quantities [8]. However, a simplified comparison between various HSG procedures can be established by comparing different parameters, which refer to input, process and output characteristics. The process relations can be summarized graphically (Figure 4).

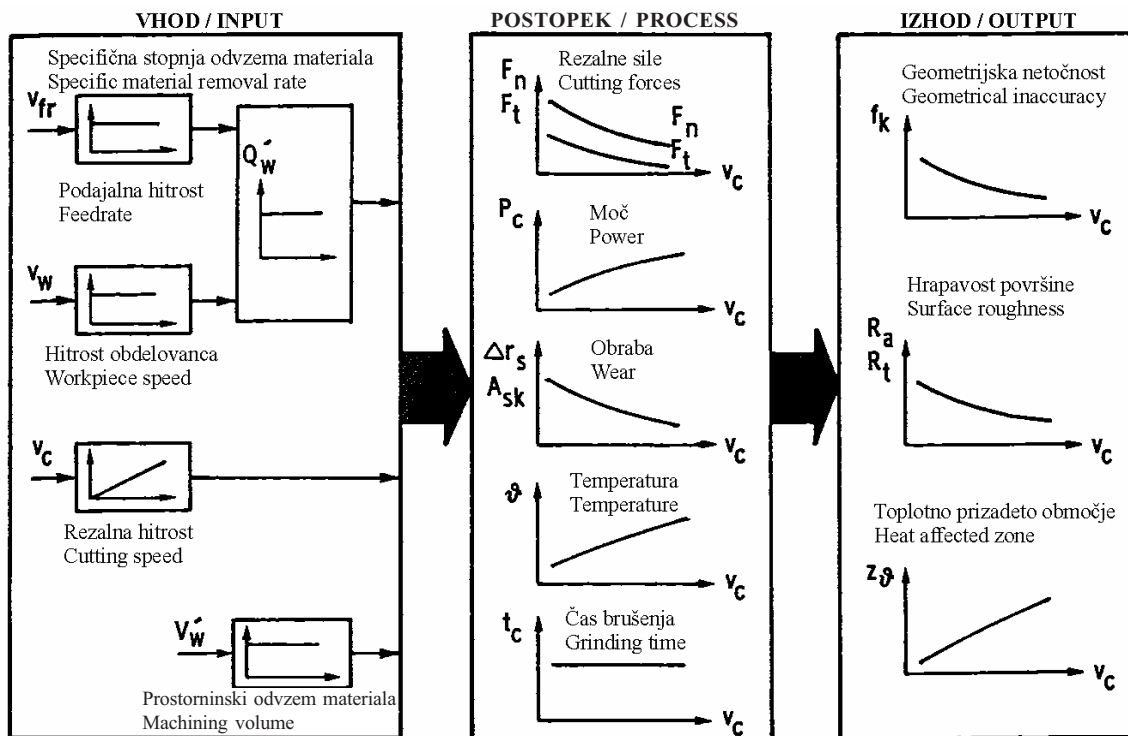

Sl. 4. Postopkovna razmerja BVH [11]  
Fig. 4. HSG process coherence [11]

Glede na naključno porazdelitev in obliko rezalnih robov so za analizo nastanka odrezka uporabljene izkustvene metode. Odvzem materiala in nastanek odrezka je odvisen od strukture brusa ter kinematičnih in geometrijskih parametrov. Debelina nedeformiranega odrezka  $h_{cu}$ , enačba (1), je torej odvisna od statične gostote rezalnih robov  $C_{stat}$ , kinematičnih in geometrijskih veličin; kjer se  $v_w$  nanaša na hitrost obdelovanca,  $v_c$  na rezalno hitrost,  $a$  na globino rezanja,  $d_{eq}$  na ekvivalenten premer brusa in  $\alpha, \beta, \gamma$  na pozitivne eksponente.

$$h_{cu} \approx k \left[ \frac{1}{C_{stat}} \right]^\alpha \left[ \frac{v_w}{v_c} \right]^\beta \left[ \frac{a}{d_{eq}} \right]^\gamma \quad \text{mm} \quad (1)$$

Na podlagi tega razmerja lahko sklepamo, da se povečanje rezalne hitrosti ob nespremenljivosti vseh preostalih parametrov izraža v zmanjšanju nedeformirane debeline odrezka. Tipična ekvivalentna debelina odrezkov pri BVH znaša med 0,5 in 10  $\mu\text{m}$ .

Specifična stopnja odvzema materiala  $Q_w'$  (2) označuje količino odvzetega materiala obdelovanca v časovni enoti na širino brusa in lahko rabi kot cenilka učinkovitosti in ekonomičnosti BVH.

$$Q_w' = \frac{Q_w}{b_D} = \frac{dV_w/dt}{b_D} \quad \text{mm}^3/\text{mm} \times \text{s} \quad (2)$$

Sposobnost brušenja določa brusno razmerje  $G$ , enačba (3), ki se nanaša na razmerje odvzete količine materiala obdelovanca in za to potrebne količine abraziva. Za doseganje ekonomičnega BVH mora biti velikost brusnega razmerja  $G$  vsaj 100. V primeru optimiranega postopka lahko dosežemo razmerja  $G$  1000 in več.

$$G = \frac{V_w}{\Delta V_s} \quad \text{mm}^3/\text{mm}^3 \quad (3)$$

S povečanjem rezalne hitrosti se razmerje  $G$  eksponentno povečuje; odrezki postajajo krajši in tanjši, obremenitev abrazivnih zrn in veziva se zmanjša, s tem pa se poveča obstojnost orodja in razmerje  $G$ .

Nadalje je pomembna določitev toplotnih lastnosti BVH, ki so odvisne od več medsebojno odvisnih spremenljivk, to so toplotne lastnosti obdelovanca in abraziva, variacije toplotne porazdelitve itn. Natančno razmerje med parametri brušenja in temperaturo je odvisno od celotnega toplotnega toka in porazdelitve toplotne energije. Slednji cenilki sta potrebni za napoved toplotnih značilnic postopka. Toplotni tok lahko ocenimo s specifično energijo za brušenje  $e_c$  en. (4).

$$e_c = A \cdot (Q_w')^{-t} \quad \text{J}/\text{mm}^3 \quad (4)$$

In view of the random distribution and shapes of cutting edges, empirical methods are applied to analyse chip formation during grinding. Material removal and chip formation depend on the structure of the grinding wheel as well as on kinematical and geometrical parameters. The undeformed chip thickness,  $h_{cu}$  (Eq.1), is therefore dependent on the static density of the cutting edges,  $C_{stat}$ , and on the kinematical and geometrical variables; where  $v_w$  is the workpiece speed,  $v_c$  the cutting speed,  $a$  the depth of cut,  $d_{eq}$  the equivalent grinding-wheel diameter, and  $\alpha, \beta, \gamma$  are positive exponents.

On the basis of this relationship it can be established that an increase in the cutting speed, assuming all other conditions are constant, will result in a reduction in the undeformed chip thickness. Equivalent chip thicknesses of between 0.5 and 10  $\mu\text{m}$  are a characteristic feature of HSG.

The specific material removal rate  $Q_w'$  (Eq.2) indicates the amount of workpiece volume removed per unit of time and the grinding contact width, which can be used as an assessment criteria for HSG performance and economics.

The grinding capacity is stated in terms of the grinding ratio  $G$  (Eq.3), which corresponds to the ratio of material removed from the workpiece and the necessary volume of abrasive required. In order to make a HSG process economic, a minimum  $G$  ratio of 100 must be aimed for. In the case of optimised processes,  $G$  ratios of 1000 and higher are not unusual.

With an increase of the cutting speed the  $G$  ratio begins to grow exponentially; the chips become shorter and thinner, the load on the abrasive and the bonding system is reduced, and therefore, the wheel life and the  $G$  ratio increase.

Furthermore, it is important to determine the thermal characteristics of HSG process, which are dependent on several interacting variables, such as the thermal properties of the workpiece and the abrasive, the variations in heat partitioning, etc. The exact relationship between the grinding parameters and the temperature depends on the total heat flux and the partitioning of the thermal energy. The latter two estimates are required for a prediction of the thermal characteristics of the process. The heat flux can be estimated from the specific grinding energy  $e_c$  (Eq.4).

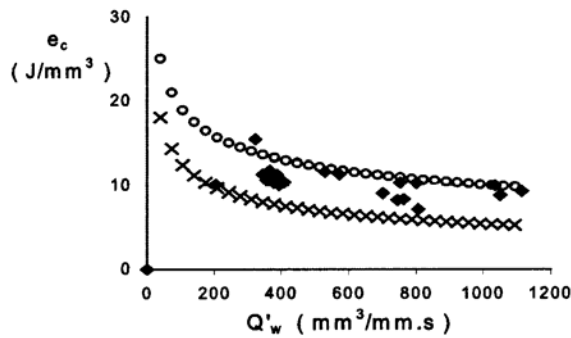

Sl. 5. Specifična energija [12]

Fig. 5. Specific energy [12]

Specifična energija za brušenje variira s specifično stopnjo odvzema materiala, kjer sta stalni  $A$  in  $t$  odvisni od materiala obdelovanca in abraziva ter razmer pri brušenju [12]. Pri majhni specifični stopnji odvzema materiala se specifična energija za brušenje povečuje in eksponentno zmanjšuje z večanjem specifične stopnje odvzema materiala (sl. 5), še posebej pri velikih rezalnih hitrostih [13].

Zanimivo dejstvo pri BVH je, da se pri zelo velikih hitrostih brusar temperatura obdelovanca značilno zniža. S povečanjem hitrosti brusar se najprej zviša, potem pa se začne pri določenih okoliščinah in pri dovolj veliki hitrosti brusar nižati (sl. 6). To si lahko razlagamo s tem, da je čas stika med abrazivnimi zrnji in obdelovancem izredno kratek. Površina obdelovanca ni v toplotnem ravnotežju in tako se toplotni impulz v začetni fazi porazdeli po površini še preden prodre v obdelovanec. Morebitno prodiranje toplote v obdelovanec pa v naslednji fazi prepreči oblikovanje naslednjega odrezka, ki jo odnese. Ti učinki so očitni pri mejni hitrosti brusar okoli 100 m/s [20].

#### 4 CELOVITOST BRUŠENE POVRŠINE IN HLADILNO MAZALNA SREDSTVA

Toplotne lastnosti brušenja se nanašajo na skoraj celotno spremembo energije za brušenje v toploto, vendar se manjši del te energije porabi za generiranje površine in kopičenje v odrezkih in obdelovancu v obliki zaostalih napetosti. Tako so vse komponente v brusni coni izpostavljene toplotnim obremenitvam [8]. Raztros toplote je odvisen od toplotne prevodnosti komponent, strategije hlajenja in značilnic postopka.

Lastnosti brušene površine bistveno vplivajo na funkcionalne lastnosti obdelane komponente. Toplotni vnos lahko povzroči strukturne spremembe, kakor so lokalne zakalitve ter formiranje trde in krhke martenzitne strukture. V povezavi z zaostalimi napetostmi lahko tako pride do nastanka in širjenja razpok (sl. 7).

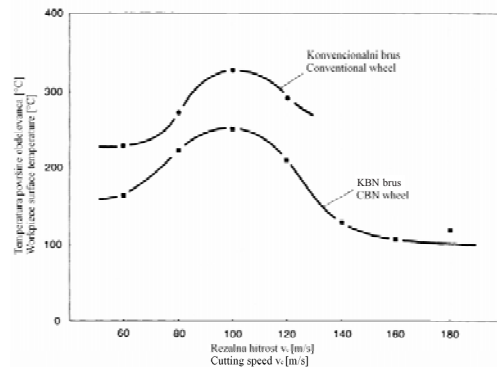

Sl. 6. Porazdelitev temperature obdelovanca [20]

Fig. 6. Workpiece temperature distribution [20]

The specific grinding energy varies with the specific MRR, where the constants  $A$  and  $t$  depend on the workpiece/abrasive material and the grinding conditions [12]. At a lower specific MRR the specific grinding energy increases, and exponentially decreases when the specific MRR increases (Figure 5), especially at high cutting speeds [13].

An interesting fact about HSG is that at very high wheel speeds the workpiece temperature drops significantly. At first the temperature rises with increasing wheel speed, but under certain circumstances if the wheel speed is increased enough the temperatures actually begin to fall again (Figure 6). The explanation given for this relates to the extremely brief period of time that the abrasive grains are in contact with the workpiece. The workpiece surface is not in thermal equilibrium and the heat pulse initially spreads out over the surface before penetrating into the workpiece. However, before this can happen, the next chip is created, taking the heat with it. The boundary wheel speed where these effects start to be apparent is about 100m/s [20].

#### 4 GROUND-SURFACE INTEGRITY AND GRINDING FLUIDS

The thermal properties of grinding result in an almost complete conversion of the grinding energy into heat; however, a smaller amount of energy is required for surface generation and the phenomena of energy residing in the chips and the workpiece in the form of residual stresses. Thus, all the components that interface in the grinding zone are subjected to thermal loads [8]. Heat dissipation is mainly dependent on the components' thermal conductivities, coolant supply strategies and process characteristics.

The properties of the ground surface layer are significant with regard to the component's operational characteristics. The thermal impact can result in structural alterations like annealed zones and the formation of a hard and brittle martensitic structure. Combined with residual stresses, this can cause crack initiation and propagation (Figure 7).

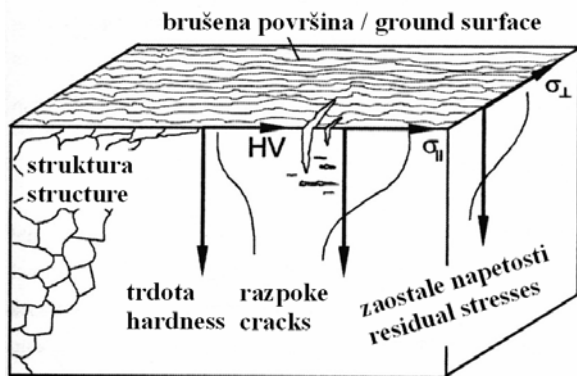

Sl. 7. Brušena površina [14]  
Fig. 7. Ground surface layer [14]

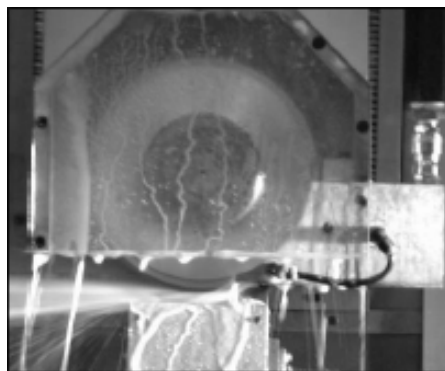

Sl. 8. Hladilno-mazalni sistem za BVH [16]  
Fig. 8. HSG cooling/lubrication system [16]

Vplive mehanskih in toplotnih učinkov na material obdelovanca opisujejo različni modeli celovitosti obdelane površine [8].

Da se izognemo toplotnim poškodbam, katere povzročijo nastajanje toplote, je bistveno znižanje temperature v brusni coni. To omogočajo hladilno-mazalna sredstva za brušenje, ki prevzamejo velik del nastale toplote. Poleg tega te tekočine tudi mažejo rezalne robove, zmanjšujejo hrapavost obdelane površine in čistijo pore brusa. Pri povečanih rezalnih hitrostih in globinah rezanja postane mazanje do določene mere pomembnejše od hlajenja. V uporabah BVH to funkcijo najbolje izpolnjujejo nekonvencionalna olja za brušenje, na osnovi estra in polialfaolefina [15].

Velike hitrosti brusa povzročajo nastanek zračne zavese, ki otežuje hlajenje in mazanje v brusni coni. Dovod hladilno-mazalnih sredstev za brušenje pod visokim tlakom omogočajo posebne razpršilne šobe. Tako tudi oblika razpršilne šobe, njen položaj in pretok vplivajo na učinkovitost in kakovost brušenja.

Toplotne poškodbe pri brušenju lahko torej povzročijo nezadosten dovod hladilno mazalnega sredstva, neprimerno načrtovan postopek, neustrezna poravnava ali prekomerna obraba brusa. Glede na to, da spada brušenje med postopke končnih obdelav, lahko zaradi toplotnih poškodb pride do zavrnitve obdelancev in nepotrebnih stroškov.

## 5 STROJI ZA BRUŠENJE Z VELIKIMI HITROSTMI

Brusi iz zelo učinkovitih abrazivov se še vedno večinoma uporabljajo na običajnih strojih za brušenje, ki so bili prvotno konstruirani za uporabo običajnih brusov. Tehnološko mejo BVH v večini primerov ne določajo orodja za brušenje, temveč brusilni stroji. Z upoštevanjem zmožnosti sodobnih abrazivov so novo razviti stroji za brušenje predstavili mejo učinkovitosti proti velikim stopnjam odvzema materiala.

The influences of mechanical and thermal grinding effects on the workpiece material can be described by various surface-integrity models [8].

In order to avoid thermal damage caused by heat generation it is crucial to lower the temperature in the grinding zone. This is achieved with grinding fluids, which dissipate a large portion of the generated heat. In addition, these fluids also lubricate the cutting edges, improve the surface finish and clean the pores in the grinding wheel. Lubrication becomes, to some extent, more important than cooling as the cutting speed and the depth of cut increase. In HSG this function is best fulfilled by unconventional grinding oils, based on esters and polyalphaolefins [15].

A high grinding-wheel speed generates a thick air curtain, which aggravates the cooling and lubrication in the grinding zone. Grinding fluids are delivered to the grinding zone via nozzles under high pressure (Figure 8). Thus, nozzle shape, positioning and flow rate also have an influence on the grinding performance and the quality.

Thermal damage during grinding can therefore be caused by an insufficient grinding-fluid supply, improperly designed processes or unsuitably dressed or worn grinding wheels. Grinding is a finishing process, and for that reason thermal damage can result in workpiece rejection and increased costs.

## 5 HSG MACHINE-TOOLS

Even today, high-performance abrasive wheels are mostly used on conventional grinding machine-tools that were originally designed for use with conventional wheels. The technological limit in HSG is, in many cases, not set by the abrasive wheels, but by the machine-tools. Newly developed machines, which take account of the capabilities of modern abrasives, have shifted the performance limit for grinding towards higher MRR.



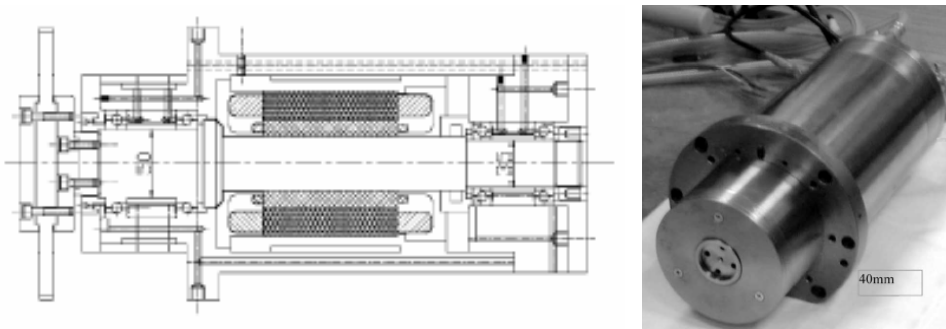

Sl. 9. Zelo hitro vreteno  
Fig. 9. High speed spindle unit

Prednosti BVH so lahko izrabljene le, ko je osnutek stroja za brušenje prilagojen zahtevam tehnologije BVH, tj. da obratuje pri velikih hitrostih. Povečanje hitrosti brusa je tesno povezana s konstrukcijo stroja. Takšno povečanje hitrosti lahko vzbudi eno izmed naravnih frekvenc stroja in povzroči slabo kakovost obdelave in zmanjšanje obstojnosti orodja. S tem mora biti posebna pozornost namenjena sami zasnovi brusilnega stroja, ki mora zmanjšati nevarnost pojava resonanc [10]. Za izvedbo BVH z velikimi rezalnimi hitrostmi je potrebno glavno vreteno, ki združuje kompaktni asinhronski motor velike moči in hibridne hidrostatične/hidrodinamične ležaje, ki omogočajo velike vrtilne frekvence (sl. 9).

Vreteno je glavni gradnik stroja za brušenje z velikimi hitrostmi in zajema 60% celotne cene stroja. Sistem brus/vreteno/motor mora obratovati ekstremno natančno in z najmanjšimi vibracijami, s čimer se zmanjša nivo dinamike postopka. S tem se zahteva velika togost celotnega stroja. Do določene mere se togost lahko poveča z uporabo sodobnih materialov z velikimi moduli elastičnosti in nosili zaprtih prerezov. S povečanjem rezalnih hitrosti se povečuje imenska moč. Zato je treba upoštevati konstrukcijsko pravilo za zmanjšanje toplotnih deformacij, ki ga dosežemo z zmanjšanjem nastale

The advantages of HSG can be exploited only when the grinding machine-tool concept is adapted to meet the requirements of HSG technology, i.e., to operate at high cutting speeds. An increased wheel speed has implications for machine-tool design. For example, an increased wheel speed can excite one of the machine-tool's natural frequencies and cause poor workpiece quality and a reduced wheel life. Thus, care must be taken in the design of HSG machine-tools to reduce the risk of resonance occurring [10]. In order to perform HSG at high cutting speeds, a grinding-wheel spindle with a compact, high-power induction motor and hydrostatic/hydrodynamic hybrid bearings, which enable high rotational speeds, is required (Figure 9).

The spindle is the key component of a HSG machine-tool and accounts for nearly 60% of the total machine-tool cost. The grinding wheel/spindle/motor system must run with extreme accuracy and minimum vibration in order to minimise the level of process dynamics. Therefore, a high level of rigidity is required for the entire machine-tool. To a certain extent, stiffness can be increased by the use of modern materials with a large Young's modulus and profiles that have closed cross-sections. Increasing the cutting speeds tends to intensify the nominal power. For this reason a design rule to minimise the influence of thermal deformations has to be considered. Thermally induced deformations have to be minimised by minimising

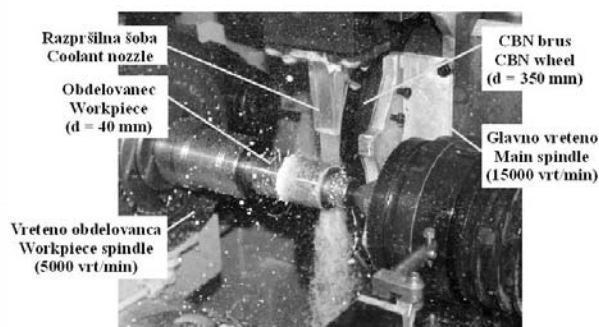
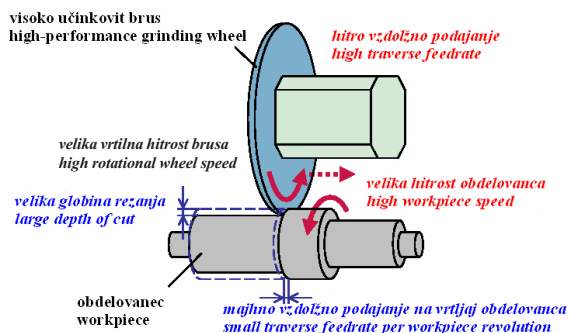

Sl. 10. Brušenje z velikimi hitrostmi KBN  
Fig. 10. CBN high-speed grinding

toplote in njenega prenosa, uporabo materialov z majhnimi razteznostnimi koeficienti in simetrično gradnjo strojev [17].

## 6 PROIZVODNA EKONOMIKA BVH

BVH izpodriva običajno brušenje zaradi zmanjšanja stroškov obdelave za en obdelovanec z največjo stopnjo odvzema materiala. Te stroškovne prednosti so posebej značilne za velikoserijsko proizvodnjo; za maloserijsko proizvodnjo je uporaba običajnih postopkov še vedno primernejša. Za določitev proizvodne ekonomike BVH se lahko uporabi naslednja stroškovna cenilka [18]:

$$C = C_1 + C_{sd} \cdot t_e + C_2 + C_3 + C_4 \quad (5)$$

$C_1$  – stalni del stroškov

$C_{sd}$  – cena strojne obdelave in dela na časovno enoto

$t_e$  – čas obdelave obdelovanca

$C_2$  – stroški orodja

$C_3$  – stroški hladilno-mazalnega sredstva

$C_4$  – dodatni stroški

BVH določa visoka cena strojne ure zaradi visoke nabavne cene stroja (~500.000 €) in velike amortizacije, močno zmanjšan čas obdelave in višji stroški orodja (~5.000 €). Višjo ceno zelo učinkovitih brusov nadomesti znatno višji obdelovalni potencial. Konkurenčnost BVH se nanaša na večjo obstojnost orodij in s tem zmanjšanjem zastojev, npr. zaradi poravnave brusa. V relativnem pomenu imajo prav stroški orodja največji potencial za prihranke celotnih stroškov BVH. Kakovost orodja je določena z učinkovitostjo brušenja in obstojnostjo. Orodje velike kakovosti omogoča večji odvzem materiala in zmanjšanje časa obdelave, ki s ceno strojne obdelave neposredno vpliva na celotne stroške brušenja (sl. 11).

the generation of heat, avoiding heat transmission, using materials with low thermal expansion coefficients and building symmetrical machines [17].

## 6 HSG EFFICIENCY ECONOMICS

HSG is replacing conventional grinding because it reduces the cost per part by maximising MRR. These cost benefits are particularly significant in high-volume production grinding; for the grinding of small series, it is generally better to continue using conventional procedures. To determine the economics of HSG the following expression for the cost estimation can be employed [18]:

$C_1$  – fixed part of the costs

$C_{sd}$  – costs of machining and labour per unit time

$t_e$  – machining time per workpiece

$C_2$  – tool costs

$C_3$  – coolant costs

$C_4$  – additional costs

HSG is characterised by a high hourly machine-tool cost because of the higher purchase costs of the machine-tool (~500,000 €) and the high depreciation, the significantly reduced machining time and the higher tool costs (~5,000 €). The higher tool cost of high-performance wheels is offset by a considerably higher machining potential. The competitiveness of HSG is related to the longer tool life and thus the reduction in downtime, e.g., dressing intervals. In relative terms, the tool costs have the greatest potential for savings in total HSG costs. The quality of the tool is defined by its grinding performance and tool life. A high-quality grinding wheel enables greater MRR and a reduction of the machining time, which takes into account the machine-tool hourly costs and in turn has a direct influence on the total grinding costs (Figure 11).

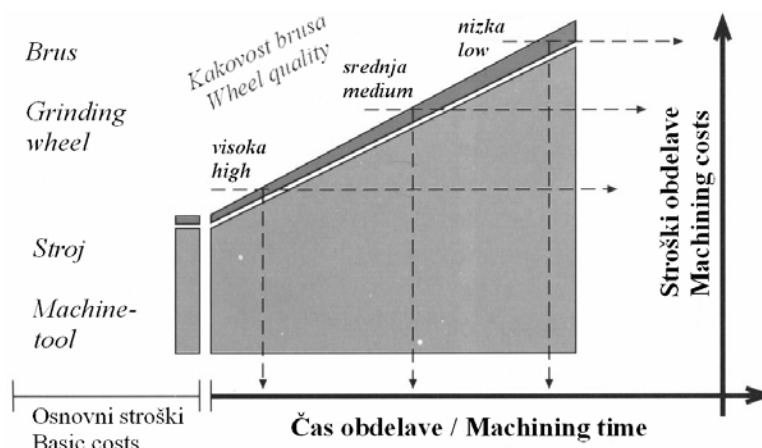

Sl. 11. Vpliv kakovosti orodja na stroške obdelave [19]

Fig. 11. The effect of grinding-wheel quality on machining costs [19]

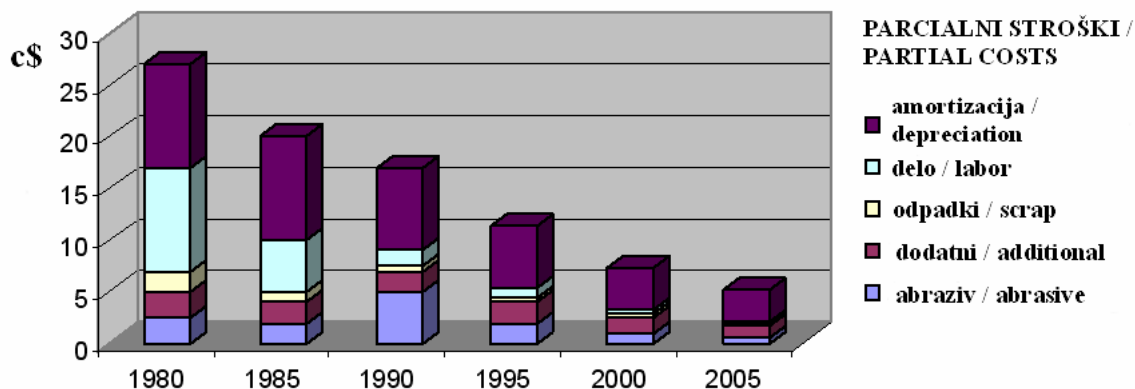

Sl. 12. Klasifikacija stroškov brušenja ležajnih mest kolenskih gredi [20]

Fig. 12. Classifying camshaft-lobe grinding costs [20]

V zadnjem desetletju je analiza stroškov BVH v avtomobilski industriji potrdila zmanjšanje celotnih stroškov obdelave za vsaj polovico (sl. 12). Raziskava se nanaša na brušenje ležajnih mest kolenskih gredi [20]. Poleg tega je napredek BVH z minimiranjem odpadkov omogočil ekološko ustrežnejše brušenje.

Primerjava stroškov običajnega in brušenja z velikimi hitrostmi je potrdila izrazite ekonomske koristi BVH za približno faktor dva.

## 7 SKLEPI

Tehnologija brušenja je znatno napredovala pri učinkovitosti, ki se nanaša na produktivnost in natančnost. K temu napredku so zlasti prispevala sodobna orodja s povečano obrabno obstojnostjo abrazivov in izboljšanimi vezivi, večja zanesljivost postopkov z boljšim nadzorom in krmiljenjem. Zato bodo nadaljnje raziskave in razvoj na področju brušenja zelo pomembne za stalno dograjevanje postopkovnega znanja. Cilji se torej nanašajo na povečano produktivnosti in prilagodljivosti kakor tudi na zmanjšanje proizvodnih stroškov. S tem dajejo sodobna orodja in stroji za brušenje ter izboljšave postopka temelj prihodnjih tehnologij brušenja.

Kakor smo poudarili, je povečana rezalna hitrost pri brušenju najpomembnejši dejavnik za izboljšanje kakovosti, obstojnosti orodja in produktivnosti. V končni fazi lahko opisno povzamemo odvisnosti postopka BVH. V tem smislu se prednosti BVH nanašajo na zmanjšanje rezalnih sil, obrabe orodij in hrapavosti obdelane površine. Z večanjem rezalne hitrosti, procesne moči oz. rezalne zmogljivosti se povečuje tudi vnos toplotne energije v obdelovanec, ki povzroča zvišanje temperature v rezalni coni, ki lahko povzroči toplotne strukturne poškodbe. Zmanjšanje stičnega časa med abrazivnim zrnom in obdelovancem ter učinkovito hlajenje lahko

A HSG cost analysis in the automotive industry over the last decade has proved a reduction in the total machining costs by at least a factor of two (Figure 12). The study refers to the grinding of steel camshaft lobes [20]. The development of HSG has also minimised scrap costs and therefore enabled ecologically appropriate grinding.

A cost comparison between conventional and high-speed grinding has also confirmed the economic benefits of HSG, which were found to be approximately a factor of two.

## 7 CONCLUSIONS

Grinding technology has improved considerably in terms of productivity and precision. Modern tools with enhanced, wear-resistant abrasives and improved bond systems together with higher process reliability due to better process monitoring and control have all contributed to this. Hence, future research and development in the field of grinding will be very important for the continuous improvement of process knowledge. The objectives therefore refer to the paradigms of increased productivity and flexibility as well as the reduction of manufacturing costs. In this way modern grinding tools and machine-tools along with improved processes form the basis for a future-oriented grinding technology.

We have emphasized that an increased grinding cutting speed is the most important factor in achieving improved quality, tool life and productivity. At last we are able to summarize HSG process coherences descriptively. In this way the advantages of HSG refer to a reduction in the grinding forces, the grinding-wheel wear, and the workpiece surface roughness. As the cutting speed and the process power increase, the quantity of thermal energy that is introduced into the workpiece also increases due to the higher cutting capacity, which causes an increase in the temperature in the cutting zone that in turn can cause thermal subsurface damage. Reducing the length of the contact time of the abrasive grain with the workpiece and efficient cooling can reduce the quan-

zmanjša količino prenosa toplote v obdelovanec in pojav toplotno prizadetega območja.

V končni fazi je treba poudariti, da ima BVH vse lastnosti za prevzem vodilne vloge na področju zelo učinkovitih tehnologij brušenja. Kljub temu BVH ni doseglo predvidenega vodilnega položaja. Prvič zaradi visokih investicijskih stroškov, povezanih z brusilnimi stroji, ki omogočajo velike hitrosti in sodobnimi orodji, ter drugič zaradi pomanjkanja temeljnega postopkovnega znanja, ki omogoča učinkovito izrabo postopka. Zaradi nedvoumne konkurenčnosti obravnavanega postopka, bo v prihodnosti tudi v slovenski industriji treba razmisliti o investicijah v sodobno opremo za zelo učinkovito brušenje. S tem predstavlja BVH nov izziv za slovensko proizvodnjo.

tity of heat transfer into the workpiece and the emergence of a heat-affected zone.

Finally, it should be stressed that HSG has all the attributes to bring it to the front position of high-performance grinding technologies. However, HSG has not achieved the dominance once envisaged. First, due to the high investment costs of high-speed machine-tools and modern grinding wheels, and second, due to a lack of fundamental process knowledge for effective process exploitation. Because of the unequivocal competitive position of the discussed procedure, Slovenian industry will necessarily have to consider future investments in modern high-performance grinding systems. In this way, HSG represents a new challenge for Slovenian manufacturing.

## 8 LITERATURA

## 8 REFERENCES

- [1] Jackson, M.J., C.J. Davis, M.P. Hitchiner, B. Mills (2001) High-speed grinding with CBN grinding wheels – Applications and future technology, *Journal of Materials Processing Technology*, 110, 78-88.
- [2] Kopač, J., P. Krajnik, A. Sluga (2003) Precision grinding and quality control, V: J. Madl (eds.). ICPM 2003, proceedings : 2nd International Congress of Precision Machining, 3-6 September 2003, Prague, Czech Republic. Department of Manufacturing Technology, Faculty of Mechanical Engineering, 36-41.
- [3] Marinič, S., A. Sluga (2001) Quality design in early phases of product development. *Manuf. syst. (Aachen)*, vol. 31, no. 2, 93-98.
- [4] Salmon, S.C. (1992) Modern grinding process technology, *McGraw-Hill*, Inc.
- [5] Muren, H. (1995) Odrezavanje in odnašanje, *Fakulteta za strojništvo, Univerza v Ljubljani*.
- [6] Klocke, F. (2001) Manufacturing technology I, *WZL-RWTH Aachen*.
- [7] Klocke, F., R. Bot (2003) Untersuchungen an Schleifscheiben aus Sol-Gel-Korund, <http://www.wzl.rwth-aachen.de>.
- [8] Tönshoff, H.K., J. Peters, I. Inasaki, T. Paul (1992) Modelling and simulation of grinding processes, *Annals of the CIRP*, Vol. 41/2, 677-688.
- [9] Yamazaki, S., K. Syoji, T. Kuriyagava, Y. Ogura (2003) Development of an ultra-high speed grinding wheel, *Key Engineering Materials Vols. 238-239, 271-276, Trans Tech Publications Switzerland*.
- [10] Ebrell, S., W.B. Rowe, M.N. Morgan (2003) Process characterisation of grinding AISI 52100 with vitrified CBN, *Key Engineering Materials Vols. 238-239, 333-340, Trans Tech Publications Switzerland*.
- [11] König, W., F. Klocke (1996) Fertigungsverfahren (Band 2), *VDI Verlag Duesseldorf*.
- [12] Stephenson, D.J., T. Jin (2003) Physical basics in grinding, V: K. Werner, F. Klocke, E. Brinksmeier (eds.). ECG 2003, proceedings : 1<sup>st</sup> European Conference on Grinding, 6-7 November 2003, Aachen, Germany. Fortschr.-Ber. VDI Reihe 2 Nr. 643, *VDI Verlag Duesseldorf*.
- [13] Ramesh, K., S. H. Yeo, S. Gowri, L. Zhou (2001) Experimental evaluation of super high-speed grinding of advanced ceramics, *The International Journal of Advanced Manufacturing Technology*, 92, 87-92, *Springer Verlag London*.
- [14] Brinksmeier, E., T. Wilke (2003) Influence of process design on residual grinding stresses, V: K. Werner, F. Klocke, E. Brinksmeier (eds.). ECG 2003, Proceedings : 1<sup>st</sup> European Conference on Grinding, 6-7 November 2003, Aachen, Germany. Fortschr.-Ber. VDI Reihe 2 Nr. 643, *VDI Verlag Duesseldorf*.
- [15] Hoerner, D. (2003) Modern grinding fluids – Can highly sophisticated base stocks improve significantly grinding performance V: K. Werner, F. Klocke, E. Brinksmeier (eds.). ECG 2003, proceedings : 1<sup>st</sup> European Conference on Grinding, 6-7 November 2003, Aachen, Germany. Fortschr.-Ber. VDI Reihe 2 Nr. 643, *VDI Verlag Duesseldorf*.
- [16] Ramesh, K., S.H. Yeo, Z.W. Zhong, K.C. Sim (2001) Coolant shoe development for high efficiency grinding, *Journal of Materials Processing Technology*, 114, 240-245..
- [17] Van Brussel, H. (2003) Contemporary state and chance of precision growth in production, V: J. Madl (eds.). ICPM 2003, Proceedings : 2nd International Congress of Precision Machining, 3-6 September 2003, Prague, Czech Republic. Department of Manufacturing Technology, Faculty of Mechanical Engineering, 36-41.



- [18] Henn, K. (1984) Qualität und Kosten beim spitzenlosen Durchlaufschleifen, Fakultät für Maschinenwesen der Rheinisch-Westfälischen Technischen Hochschule Aachen.
- [19] Haefli, P., H. Reiser (2000) High-precision profile grinding with PremaDia, Grinding of Metals, Diamond for Industry, *De Beers Industrial Diamonds*.
- [20] Hitchiner, M. (2003) Practical challenges to the application of high wheel speeds to grinding, INTERTECH 2003, Proceedings: An International Technical Conference on diamond, Cubic Boron Nitride and Their Applications, 28 July-1 August 2003, Vancouver, *The Industrial Diamond Association of America*.

Naslov avtorjev: Peter Krajnik  
prof.dr. Janez Kopač  
Univerza v Ljubljani  
Fakulteta za strojništvo  
Aškerčeva 6  
1000 Ljubljana  
peter.krajnik@fs.uni-lj.si  
janez.kopac@fs.uni-lj.si

Authors' Address: Peter Krajnik  
Prof.Dr. Janez Kopač  
University of Ljubljana  
Faculty of Mechanical Eng.  
Aškerčeva 6  
SI-1000 Ljubljana, Slovenia  
peter.krajnik@fs.uni-lj.si  
janez.kopac@fs.uni-lj.si

Prejeto: 13.1.2004  
Received:

Sprejeto: 8.4.2004  
Accepted:

Odprto za diskusijo: 1 leto  
Open for discussion: 1 year