

## Dinamični model rotorskega sistema z gibkim členom in dvema nesoosnima gredema

### A Dynamic Model of a Rotor System Consisting of a Flexible Link with Misaligned Shafts

Marijonas Bogdevičius - Bronislovas Spruogis - Vytautas Turla

*Zanesljivost in trajnost strojno gnanih sistemov, ki jih uporabljamo v prenosih, sta odvisni od izbire povezovalnih elementov v gonilih. Pomembno je, da pri takšnih sistemih pravilno ocenimo in izravnamo pojav nesoosnosti. V pričujočem prispevku predstavljamo dinamični model rotorskega sistema, ki sestoji iz motorja in delovnega stroja z gredema, ki sta povezani z elastično izravnalno gredno vezjo.*

*Enačbe gibanja polovičnih grednih vezi in rotorskih sistemov smo izpeljali na način, ki omogoča določitev kinetične in potencialne energije, kinetičnih in dinamičnih parametrov deformiranega sistema ter lege in oblike gibkega člana, ki povezuje sistem. Izračunali smo tudi krivuljo pospeškov elastičnih sil gibkega člana (gredne vezi).*

© 2004 Strojniški vestnik. Vse pravice pridržane.

**(Ključne besede: gonila kompleksna, vezi gredne, nesoosnost, modeli dinamični, metode končnih elementov)**

*The reliability and durability of the machine-drive systems used in transport depend on the selection of the connecting elements used in the drives. In such systems the evaluation and compensation of incoaxiality is an important task. In this paper we discuss the dynamic model of a rotary system consisting of an engine and a working machine with the shafts connected by an elastic compensation coupling.*

*The equations of motion of the half-couplings and the rotary systems are derived in such a way that the kinetic and potential energies, the kinetic and dynamic parameters of the deformed system, and the location and shape of the flexible link joining the system can be determined. We have also calculated the hodograph of the elastic forces of the flexible link (coupling).*

© 2004 Journal of Mechanical Engineering. All rights reserved.

**(Keywords: complex drive, couplings, misalignment, dynamic models, finite element methods)**

#### 0 UVOD

Rotorski sistem sestoji iz mnogih, sočasno vrtečih se, členov. Zaradi nesoosnosti grednih vezi, neuravnoveženosti posameznih delov, zunanjih in drugih motenj ter zaradi sprememb v dovedeni energiji se členi vrtijo nepravilno. Ti dejavniki povzročijo povečanje dinamične obremenitve v strojih in mehanizmih, kar poveča vrtilno vibriranje. V pričujoči študiji smo raziskovali, kako lahko zmanjšamo vrtilno vibriranje in sile, ki ga povzročajo. Ugotovili smo, da je eden najbolj učinkovitih načinov zmanjšanja vibracij izboljšanje konstrukcije strojnih sestavnih delov in zamenjava teh elementov z deli, ki so odporni proti vibriranju. Za ta namen lahko uporabimo učinkovite naprave za prenos kroženja in za stabilizacijo, npr.: različne sklopke in dušilnike vibriranja.

#### 0 INTRODUCTION

A rotor system consists of many synchronously rotating links. Because of the misalignment of the coupling-link shafts, the non-balanced parts, the external and other disturbances, and the variations in the supplied energy, the links rotate irregularly. These factors result in an increased dynamic load in machines and mechanisms that gives rise to rotary vibration. In this study we have investigated how to reduce these rotary vibrations and the forces that cause them. We found that one of the most effective ways of decreasing vibrations is to improve the construction of the machine's assembly elements and substitute these elements with parts that are resistant to vibration. For this we can use effective rotary-motion transmission and stabilization devices in the form of various clutches and vibration dampers.

Tu predstavljamo dinamično analizo nelinearne, torzijske, gibke gredne vezi z elastičnimi členi [1]. Z rezultati analize ravnovesnega stanja in prehodnega osciliranja smo določili optimalna razmerja grednih vezi. Mohiuddin in Khulief [2] sta prikazala splošni dinamični model velikega sistema rotorskih ležajev z razpokano gredjo. Model predvideva gredi s klinastimi deli, več diskov in anizotropne ležaje. Upoštevali smo tudi vpliv togosti gibke gredne vezi na amplitudo torzijskega vrtilnega momenta [3].

Trdnost in zanesljivost zobnikov v stroju sta močno odvisni od izbire pravih elementov gredne vezi. V primeru takšnih strojev je zelo pomembno, da pravilno ocenimo izravnavo nesoosnosti gredi. V pričujoči študiji predstavljamo dinamični model rotorskega sistema, ki sestoji iz asinhronnega motorja in delovnega stroja, čigar gredi sta povezani s izravnalno sklopko. Sklopka, ki rabi kot gibek člen med motorjem in gredema delovnega stroja, ima lahko različne prostostne stopnje. Glede nesoosnosti pa smo dinamično povezanih gredi rešili z uporabo metode končnih elementov.

Za prikaz geometrijske oblike gredne vezi in člena med polovičnima grednima vezema v primeru nesoosnih gredi uporabimo zapletene elemente. Izpeljemo matematične odvisnosti med globalnimi točkami sklopke v začetnih in deformiranih legah in določimo njihove soodnose. Ugotovimo matematičen odnos med silami, ki delujejo na zapletene elemente sklopke; prav tako izračunamo sile in momente, ki delujejo v polovični gredni vezi in se prenašajo na pripadajoči gredi ter na podporne dele. Razvijemo enačbe gibanja za sistem polovične gredne vezi in rotorja ter jih združimo v matematični model. Dobljena rešitev omogoči, da izračunamo kinetično in potencialno energijo, kinematične in dinamične parametre deformiranih sistemov ter ugotovimo lego in obliko gibke gredne vezi.

## 1 DINAMIČNI MODEL ROTORSKEGA SISTEMA

Analizirali bomo sistem, ki je sestavljen iz motorja in delovnega stroja, čigar gredi sta povezani z gibko gredno vezjo (gibko sklopko – GS). Motor in delovni stroj sta pritrjena na gibke opornike, ki dušijo vibriranje. Predpostavljamo, da so okvir delovnega stroja in diski rotorjev popolnoma togi, kar pomeni, da ima sistem zgoščene parametre. Dinamiko povezanih gredi bomo raziskali z metodo končnih elementov (MKE).

Zunanje vzbujanje sistema je posledica radialne in kotne nesoosnosti povezanih gredi motorja in delovnega stroja. Naredili smo naslednje predpostavke: deformacije so majhne, gredi rotorjev sta gibki telesi in bočne sile so zanemarljive.

We present a dynamic analysis of a nonlinear torsional flexible coupling with elastic links [1]. The results of analyses of the steady-state and transient-oscillation performances are applied to determine optimum proportions for the couplings. Mohiuddin and Khulief [2] presented a general dynamic model for a large-scale rotor-bearing system with a cracked shaft. The model accommodates shafts with tapered portions, multiple disks and anisotropic bearings. The influence of the stiffness of a flexible coupling on the amplitude of the torsional torque is considered [3].

The strength and the reliability of the gears in machines very much depend on choosing the right coupling elements. For such machines it is very important to evaluate the compensation of the shafts' misalignment. In this study we present a dynamic model of a rotor system consisting of an asynchronous engine and a working machine, the shafts of which are connected by a compensating clutch. The clutch, which serves as a flexible link between the engine and the shafts of the working machine, can have many degrees of freedom. For the case of misalignment, the dynamics of the connected shafts is solved using the finite-element method.

We present the geometry of the coupling as well as the link between its half-couplings using complex elements for the case when the shafts are misaligned. We derive mathematical dependencies between the global points of the clutches in the initial and deformed positions and determine their interrelations. We establish a mathematical relation between the forces influencing the complex elements of the clutch; and the forces and moments acting in the half-coupling, which are transferred to the corresponding shafts and the support parts, are calculated. We develop the equations of motion for the half-coupling and the rotor system and join them in a mathematical model. The solution allows us to calculate the kinetic and potential energies, the kinematics and dynamics parameters of the deformed systems, as well as establish the location and the shape of the flexible coupling.

## 1 DYNAMIC MODEL OF A ROTOR SYSTEM

We will analyse a system composed of an engine and a working machine, whose shafts are connected by a flexible coupling (a flexible clutch – FC). The engine and the working machine are attached to flexible supports that suppress the vibration. We assume that the frame of the working machine and the disks of the rotors are absolutely stiff, i.e., the system possesses concentrated parameters. The dynamics of the connected shafts will be investigated using the finite-element method (FEM).

The external excitation of the system is caused by the radial and angular misalignment of the connected engine and working-machine shafts. We have made the following assumptions: the deformations are small, the shafts of the rotors are flexible bodies, and the lateral forces are negligible.

Slika 1 prikazuje dinamični model rotorskega sistema, čigar globalni sistem koordinat je  $OXYZ$ . Za sistem prve polovične gredne vezi smo izbrali koordinatni sistem  $O_1X_1Y_1Z_1$ , za sistem druge polovične gredne vezi pa smo izbrali koordinatni sistem  $O_2X_2Y_2Z_2$ . Vsaka polovična gredna vez ima lahko šest prostostnih stopenj. Poleg tega ima lahko gibka gredna vez (GS) še precej več notranjih prostostnih stopenj (v odvisnosti od strukture povezovalne gredne vezi). Dinamiko modela smo razrešili z uporabo MKE. Vrednosti začetnih deformacij gredi so znane. Analizirali bomo, kako nastane deformacija rotorskega sistema, prav tako bomo ugotovili premike, kote deformacije in njihove odvode ([4] do [10]).

Fig. 1 shows the dynamic model of the rotor system, whose global system of coordinates is  $OXYZ$ . For the system of the first half-coupling we selected the  $O_1X_1Y_1Z_1$  coordinate system, while for the system of the second half-coupling we selected the  $O_2X_2Y_2Z_2$  coordinate system. Every half-coupling can have six degrees of freedom. Furthermore, a flexible coupling (FC) can have many more internal degrees of freedom (depending on the structure of the connecting coupling). The dynamics is solved using the FEM. The values of the initial deformations of a shaft are known. We will analyse how the deformation of the rotor system occurs, and we will also find the displacements, the angles of deformation and their derivatives ([4] to [10]).

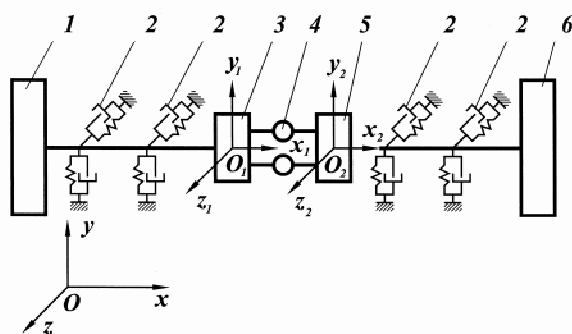

Sl. 1. Dinamični model rotorskega sistema: 1 – rotor motorja; 2 – gibki oporniki; 3 – prva polovična gredna vez; 4 – gibki povezovalni elementi polovične gredne vezi; 5 – druga polovična gredna vez; 6 – rotor delovnega stroja; I – gonilna gred; II – gnana gred

Fig. 1. Dynamic model of the rotor system: 1 – engine rotor; 2 – flexible supports; 3 – first half-coupling; 4 – half-coupling's flexible connecting elements; 5 – second half-coupling; 6 – rotor of the working machine; I – driving shaft; II – driven shaft

### 1.1 Geometrijska oblika sklopke

Analizirali bomo splošen primer sklopke: gonilna gred I in gnana gred II rotorskega sistema sta povezani s polovično gredno vezjo. Števili prve in druge polovične gredne vezi sta  $i = 1$  in  $i = 2$ . Števila zapletenih elementov (KE) v gibki gredni vezi so  $j = 1, 2, \dots, NZ$ , pri čemer je  $NZ$  skupno število zapletenih

### 1.1 Geometry of the Clutch

We will analyse a general case for the clutch: the driving shaft I and the driven shaft II of the rotor system are connected by a half-coupling. The numbers of the first and second half-couplings are  $i = 1$  and  $i = 2$ . The numbers of the complex elements (CE) in the flexible coupling are  $j = 1, 2, \dots, NZ$ , where

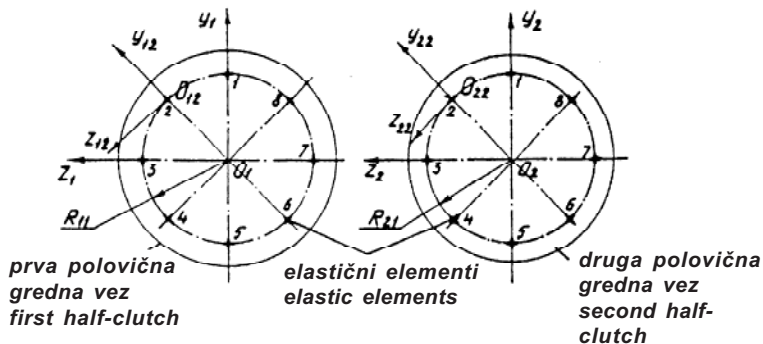

Sl. 2. Shematični prikaz geometrije gredne vezi, če je  $NZ = 8$   
Fig. 2. Schematic view of the coupling geometry when  $NZ = 8$

elementov v gibki gredni vezi (sl. 2). Zahtevni elementi so razvrščeni v krogih s premeroma  $R_{11}$  in  $R_{21}$  (sl. 2).

Točke so določene s koordinatnim sistemom  $O_{ij}X_{ij}Y_{ij}Z_{ij}$ . Polovični gredni vezi sta povezani z zapletenimi elementi, od katerih vsak sestoji iz treh elementov (sl. 3).

$NZ$  is the total number of complex elements in the flexible coupling (Fig.2). The complex elements are arranged in circles with radii  $R_{11}$  and  $R_{21}$  (Fig. 2).

The points are defined in the coordinate system  $O_{ij}X_{ij}Y_{ij}Z_{ij}$ . The half-couplings are interlinked by complex elements, with each of them consisting of three elements (Fig. 3).

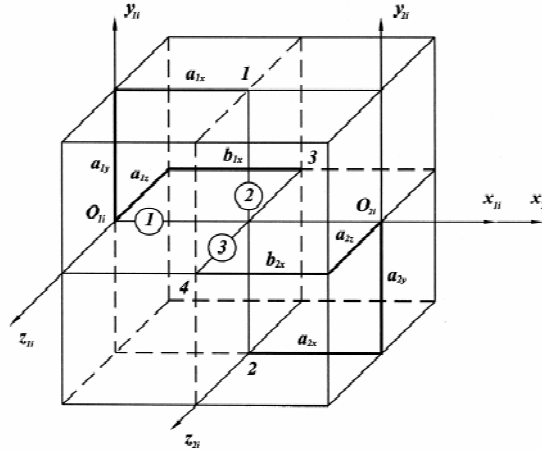

Sl. 3. Zahtevni element: 1 – prvi element deluje v vzdolžni smeri; 2 – drugi element deluje v prečni smeri; 3 – tretji element deluje pravokotno na prečno in vzdolžno smer

Fig. 3. Complex element: 1 – the first element acts in the axial direction; 2 – the second element acts in the radial direction; 3 – the third element acts perpendicular to the radial and axial directions

### 1.2 Sile in momenti sil, ki delujejo na zapletene elemente

Koordinate točk  $O_1$  in  $O_2$  v koordinatnem sistemu  $OXYZ$  (sl. 1) so naslednje:

$$\{X\}_{O_1} = \{X_0\}_{O_1} + \{U(t)\}_{O_1} \quad (1)$$

$$\{X\}_{O_2} = \{X_0\}_{O_2} + \{U(t)\}_{O_2} \quad (2),$$

kjer so  $\{X_0\}_{O_1}$ ,  $\{X_0\}_{O_2}$  začetne koordinate točk  $O_1$  in  $O_2$ , in sta  $\{U(t)\}_{O_1}$ ,  $\{U(t)\}_{O_2}$  premika točk  $O_1$  in  $O_2$ .

Razmerje med koordinatnima sistemoma  $O_1X_1Y_1Z_1$  in  $O_{1i}X_{1i}Y_{1i}Z_{1i}$  lahko izrazimo takole:

$$\{X_1\} = \{X_{1i}\}_{1i} + [G_{1i}]\{X_{1i}\} \quad (3),$$

kjer so  $\{X_{1i}\}_{1i}$  koordinate točke  $O_{1i}$  v koordinatnem sistemu  $O_{1i}X_{1i}Y_{1i}Z_{1i}$ ,  $[G_{1i}]$  matrika koordinatne premene in  $\{X_{1i}\}$  koordinate zapletenega elementa  $i$  polovične gredne vezi 1.

Razmerje med koordinatnima sistemoma  $O_2X_2Y_2Z_2$  in  $O_{2i}X_{2i}Y_{2i}Z_{2i}$  lahko izrazimo na naslednji način:

$$\{X_2\} = \{X_{2i}\}_{2i} + [G_{2i}]\{X_{2i}\} \quad (4),$$

### 1.2 Forces and moments of the forces acting on the complex elements

The coordinates of points  $O_1$  and  $O_2$  in the coordinate system  $OXYZ$  (Fig. 1) are as follows:

where  $\{X_0\}_{O_1}$ ,  $\{X_0\}_{O_2}$  are the initial coordinates of the points  $O_1$  and  $O_2$ , and  $\{U(t)\}_{O_1}$ ,  $\{U(t)\}_{O_2}$  are the displacements of the points  $O_1$  and  $O_2$ .

The relationship between the coordinate systems  $O_1X_1Y_1Z_1$  and  $O_{1i}X_{1i}Y_{1i}Z_{1i}$  can be expressed as follows:

where  $\{X_{1i}\}_{1i}$  are the coordinates of the point  $O_{1i}$  in the  $O_{1i}X_{1i}Y_{1i}Z_{1i}$  coordinate system,  $[G_{1i}]$  is the matrix of coordinates transformation, and  $\{X_{1i}\}$  are the coordinates of the complex element  $i$  of the half-coupling 1.

The relationship between the coordinate systems  $O_2X_2Y_2Z_2$  and  $O_{2i}X_{2i}Y_{2i}Z_{2i}$  can be expressed as follows:

kjer so  $\{X_{2i}\}_{2i}$  koordinate točke  $O_{2i}$  v koordinatnem sistemu  $O_2X_2Y_2Z_2$ ,  $[G_{2i}]$  matrika koordinatne premene in  $\{X_{2i}\}$  koordinate zahtevnega elementa  $i$  polovične gredne vezi 2.

Razdalja med točkama  $O_{1i}$  in  $O_{2i}$  je naslednja:

$$\{L_{i,1}(t)\} = \{X\}_{2i} - \{X\}_{1i} = \{X_0\}_{O_2} + \{U(t)\}_{O_2} + [A_2]\{X_{2i}\}_{2i} - \{X_0\}_{O_1} - \{U(t)\}_{O_1} - [A_1]\{X_{1i}\}_{1i} \quad (5)$$

in časovni odvod vektorja  $\{L_{i,1}(t)\}$  je:

$$\frac{d}{dt}\{L_{i,1}(t)\} = \{\dot{U}(t)\}_{O_2} + [\dot{A}_2]\{X_{2i}\}_{2i} - \{\dot{U}(t)\}_{O_1} - [\dot{A}_1]\{X_{1i}\}_{1i} \quad (6),$$

kjer sta  $[A_1], [A_2]$  matriki koordinatne premene;

$$\frac{d}{dt}[A_i] = [\dot{A}_i], \quad \text{in/and} \quad \frac{d}{dt}\{U(t)\} = \{\dot{U}(t)\} \quad i = 1, 2$$

Premik med točkama  $O_{1i}$  in  $O_{2i}$  je:

$$\Delta L_{i,1}(t) = |\{L_{i,1}(t)\}| - |\{L_{i,1}(t=0)\}| \quad (7).$$

Premik prvega elementa v  $i$ -tem zahtevnem elementu je:

$$\Delta U_{i,1}(t) = \begin{cases} \Delta L_{i,1}(t), & \Delta L_{i,1}(t) < 0 \\ 0, & \Delta L_{i,1}(t) \geq 0 \end{cases} \quad (8).$$

Hitrost premika prvega elementa v  $i$ -tem zahtevnem elementu izrazimo takole:

$$\Delta \dot{U}_{i,1}(t) = \frac{d}{dt}(\Delta L_{i,1}(t)) = \frac{d}{dt}|\{L_{i,1}(t)\}| - \frac{d}{dt}|\{L_{i,1}(t=0)\}| = \frac{d}{dt}|\{L_{i,1}(t)\}| = \frac{\{\dot{L}_{i,1}(t)\}^T \{L_{i,1}(t)\}}{|\{L_{i,1}(t)\}|} \quad (9).$$

Razdalja med točko 1 in točko 2 v  $i$ -tem zahtevnem elementu prve polovične gredne vezi in druge polovične gredne vezi je naslednja:

$$\{L_{i,2}(t)\} = \{X\}_{2i,2} - \{X\}_{1i,1} = \{X_0\}_{O_2} + \{U(t)\}_{O_2} + [A_2](\{X_{2i}\}_{2i} + [G_{2i}]\{X_{2i,2}\}) - \{X_0\}_{O_1} - \{U(t)\}_{O_1} - [A_1](\{X_{1i}\}_{1i} + [G_{1i}]\{X_{1i,1}\}) \quad (10),$$

kjer je  $\{X_{1i,1}\}^T = [a_{1x}, a_{1y}, 0]$ ;  $\{X_{2i,2}\}^T = [-a_{2x}, -a_{2y}, 0]$  (glej sl. 3).

Časovni odvod je:

$$\frac{d}{dt}\{L_{i,2}(t)\} = \{\dot{U}(t)\}_{O_2} + [\dot{A}_2](\{X_{2i}\}_{2i} + [G_{2i}]\{X_{2i,2}\}) - \{\dot{U}(t)\}_{O_1} - [\dot{A}_1](\{X_{1i}\}_{1i} + [G_{1i}]\{X_{1i,1}\}) \quad (11).$$

Premik med točkama 2 in 1 v drugem elementu  $i$ -tega zahtevnega elementa je:

$$\Delta L_{i,2}(t) = |\{L_{i,2}(t)\}| - |\{L_{i,2}(t=0)\}| \quad (12).$$

$$\Delta U_{i,2}(t) = \begin{cases} 0, & \Delta L_{i,2}(t) \geq 0 \\ \Delta L_{i,2}(t), & \Delta L_{i,2}(t) < 0 \end{cases} \quad (13).$$

Hitrost premika v drugem elementu zahtevnega  $i$ -tega elementa lahko izrazimo takole:

where  $\{X_{2i}\}_{2i}$  are the coordinates of point  $O_{2i}$  in the  $O_2X_2Y_2Z_2$  coordinate system,  $[G_{2i}]$  is the matrix of coordinates transformation, and  $\{X_{2i}\}$  are the coordinates of the complex element  $i$  of the half-coupling 2.

The distance between the points  $O_{1i}$  and  $O_{2i}$  is as follows:

and the derivative of vector  $\{L_{i,1}(t)\}$  with respect to time is equal to:

where  $[A_1], [A_2]$  are the matrices of coordinates transformation;

The displacement between the points  $O_{1i}$  and  $O_{2i}$  is:

The displacement of the first element in the  $i$ -th complex element is:

The velocity at which the displacement of the first element in the  $i$ -th complex element takes place is expressed as:

The distance between point 1 and point 2 in the  $i$ -th complex element of the first half-coupling and the second half-coupling is equal to:

where  $\{X_{1i,1}\}^T = [a_{1x}, a_{1y}, 0]$ ;  $\{X_{2i,2}\}^T = [-a_{2x}, -a_{2y}, 0]$  (see Fig.3).

The derivative with respect to time is as follows:

The displacement between points 2 and 1 in the second element of the  $i$ -th complex element is equal to:

The velocity of the displacement in the second element of the  $i$ -th complex element can be expressed as:

$$\Delta \dot{U}_{1,2}(t) = \frac{d}{dt}(\Delta L_{1,2}(t)) = \frac{\{\dot{L}_{1,2}(t)\}^T \{L_{1,2}(t)\}}{\{|L_{1,2}(t)|\}} \quad (14).$$

Razdalja med točko 3 in točko 4 v  $i$ -tem zahtevnem elementu prve in druge polovične gredne vezi je:

The distance between point 3 and point 4 in the  $i$ -th complex element of the first and the second half-coupling is equal to:

$$\begin{aligned} \{L_{i,3}(t)\} = \{X\}_{2i,4} - \{X\}_{1i,3} = \{X_0\}_{02} + \{U(t)\}_{02} + [A_2] (\{X_2\}_{2i} + [G_{2i}] \{X_{2i}\}_4) - \\ \{X_0\}_{01} - \{U(t)\}_{01} - [A_1] (\{X_1\}_{1i} + [G_{1i}] \{X_{1i}\}_3) \end{aligned} \quad (15),$$

kjer je  $\{X_{1i,3}\}^T = [b_{1x}, 0, -a_{1z}]$ ;  $\{X_{2i,4}\}^T = [-b_{2x}, 0, -a_{2z}]$  (glej sl. 3).

where  $\{X_{1i,3}\}^T = [b_{1x}, 0, -a_{1z}]$ ;  $\{X_{2i,4}\}^T = [-b_{2x}, 0, -a_{2z}]$  (see Fig.3).

Časovni odvod vektorja je:

The derivative of the vector with respect to time is as follows:

$$\frac{d}{dt} \{L_{i,3}(t)\} = \{\dot{U}(t)\}_{02} + [A_2] (\{X_2\}_{2i} + [G_{2i}] \{X_{2i,4}\}) - \{\dot{U}(t)\}_{01} - [A_1] (\{X_1\}_{1i} + [G_{1i}] \{X_{1i,3}\}). \quad (16).$$

Premik tretjega elementa  $i$ -tega zahtevnega elementa je naslednji:

The displacement of the 3rd element of the  $i$ -th complex element is as follows:

$$\Delta U_{i,3}(t) = \Delta L_{i,3}(t) = \left| \{L_{i,3}(t)\} \right| - \left| \{L_{i,3}(t=0)\} \right| \quad (17).$$

Hitrost premika v tretjem elementu  $i$ -tega zahtevnega elementa lahko izrazimo takole:

The velocity of displacement in the third element of the  $i$ -th complex element can be expressed as:

$$\Delta \dot{U}_{i,3}(t) = \frac{d}{dt} \left( \left| \{L_{i,3}(t)\} \right| - \left| \{L_{i,3}(t=0)\} \right| \right) = \frac{\{\dot{L}_{i,3}(t)\}^T \{L_{i,3}(t)\}}{\{|L_{i,3}(t)\}|} \quad (18).$$

Sila, ki deluje na prvi element  $i$ -tega zahtevnega elementa, je:

The force acting on the first element of the  $i$ -th complex element is as follows:

$$\{F_{i,1}(t)\} = F_{i,1}(\Delta U_{i,1}(t), \Delta \dot{U}_{i,1}(t)) \frac{\{L_{i,1}(t)\}}{\{|L_{i,1}(t)\}|} \quad (19),$$

kjer je

where

$$F_{i,1}(\Delta U_{i,1}(t), \Delta \dot{U}_{i,1}(t)) = (F_{T,i,1} + f_{T,i,2} F_{i,2}^N + f_{T,i,3} F_{i,3}^N) \text{sign}(\Delta \dot{U}_{i,2}(t)) + \sum_{k=1}^{n_1} (k_{1i,2i,k} \cdot \Delta U_{i,1}^k(t) + h_{1i,2i,k} \cdot \Delta \dot{U}_{i,1}^k(t)) \quad (20),$$

kjer je  $F_{T,i,1}$  sila trenja;  $F_{i,2}^N, F_{i,3}^N$  sta normalni sili, ki sta iz drugega in tretjega elementa preneseni na prvi element;  $f_{T,i,2}, f_{T,i,3}$  sta koeficienta trenja;  $k_{1i,2i,k}, h_{1i,2i,k}$  sta koeficienta togosti oziroma dušenja;  $n_1$  je število elementov.

where  $F_{T,i,1}$  is the frictional force;  $F_{i,2}^N, F_{i,3}^N$  are the normal forces transferred to the first element from the second and third elements;  $f_{T,i,2}, f_{T,i,3}$  are the frictional coefficients;  $k_{1i,2i,k}, h_{1i,2i,k}$  are the stiffness and damping coefficients, respectively; and  $n_1$  is the number of elements.

Sila, ki deluje na drugi element  $i$ -tega zahtevnega elementa, je enaka:

The force acting on the second element of the  $i$ -th complex element is equal to:

$$\{F_{i,2}(t)\} = F_{i,2}(\Delta U_{i,2}(t), \Delta \dot{U}_{i,2}(t)) \frac{\{L_{i,2}(t)\}}{\{|L_{i,2}(t)\}|} \quad (21),$$

kjer je

where

$$F_{i,2}(\Delta U_{i,2}(t), \Delta \dot{U}_{i,2}(t)) = (F_{T,i,2} + f_{T,i,1} F_{i,1}^N + f_{T,i,3} F_{i,3}^N) \text{sign}(\Delta \dot{U}_{i,2}(t)) + \sum_{k=1}^{n_2} (k_{12,k} \cdot \Delta U_{i,2}^k(t) + h_{12,k} \cdot \Delta \dot{U}_{i,2}^k(t)) \quad (22),$$

kjer je  $F_{T,i,2}$  sila trenja;  $F_{i,2}^N, F_{i,3}^N$  sta normalni sili, ki sta iz prvega in tretjega elementa preneseni na drugi strukturni element;  $f_{T,i,2}, f_{T,i,3}$  sta koeficienta trenja;  $k_{12,k}, h_{12,k}$  sta koeficienta togosti oziroma dušenja;  $n_2$  je število elementov.

where  $F_{T,i,2}$  is the frictional force;  $F_{i,2}^N, F_{i,3}^N$  are the normal forces transferred to the second structural element from the first and third elements;  $f_{T,i,2}, f_{T,i,3}$  are the frictional coefficients;  $k_{12,k}, h_{12,k}$  are the stiffness and damping coefficients, respectively;  $n_2$  is the number of elements.

Sila, ki deluje na tretji sestavni element, je enaka:

The force acting on the third structural element is equal to:

$$\{F_{i,3}(t)\} = F_{i,3}(\Delta U_{i,3}(t), \Delta \dot{U}_{i,3}(t)) \frac{\{L_{i,3}(t)\}}{\{\dot{L}_{i,3}(t)\}} \quad (23)$$

$$F_{i,3}(\Delta U_{i,3}(t), \Delta \dot{U}_{i,3}(t)) = \sum_{k=1}^{n_3} k_{34,k} \cdot \Delta U_{i,3}^k(t) + h_{34,k} \cdot \Delta \dot{U}_{i,3}^k(t) \quad (24),$$

kjer sta  $k_{34,k}, h_{34,k}$  koeficienta togosti oziroma dušenja. Moment sile lahko izrazimo takole:

where  $k_{34,k}, h_{34,k}$  are the stiffness and damping coefficients, respectively.

The moment of force can be expressed as follows:

$$\{M\} = \{r\} \times \{F\} = [B] \{F\} \quad (25),$$

kjer je  $[B]$  antisimetrična matrika:

where  $[B]$  is the skew-symmetric matrix:

$$[B] = \begin{bmatrix} 0 & -r_z & r_y \\ r_z & 0 & -r_x \\ -r_y & r_x & 0 \end{bmatrix}$$

in so  $r_x, r_y, r_z$  projekcije razdalje.

and  $r_x, r_y, r_z$  are the projections of radius.

Vektor vsote sil, ki delujejo na prvi, drugi in tretji element v vsakem zahtevnem elementu prve polovične gredne vezi glede na točko  $O_1$ , je:

The vector of the total force relative to the point  $O_1$  of the forces acting on the first, second and third elements in each complex element of the first half-coupling is:

$$\{F_{O1}\} = \sum_{i=1}^{NZ} \sum_{j=1}^3 \{F_{i,j}\} \quad (26).$$

Vektor celotnega momenta sil, ki delujejo na prvi, drugi in tretji element v vsakem zahtevnem elementu prve polovične gredne vezi glede na točko  $O_1$ , je:

The vector of the total moment relative to the point  $O_1$  of the forces acting on the first, second and third elements in each complex element of the first half-coupling is:

$$\{M_{O1}\} = \sum_{i=1}^{NZ} \sum_{j=1}^3 \{r_{O1}\}_{i,j} \times \{F_{i,j}\} = \sum_{i=1}^{NZ} \sum_{j=1}^3 [B_{O1}]_{i,j} \{F_{i,j}\} \quad (27),$$

kjer so  $\{r_{O1}\}_{i,j}$  koordinate točke, v kateri deluje sila  $\{F_{i,j}\}$ ;  $[B_{O1}]_{i,j}$  je antisimetrična matrika, ki je dobljena iz vektorja  $\{r_{O1}\}_{i,j}$ .

where  $\{r_{O1}\}_{i,j}$  are the coordinates of the point in which the force  $\{F_{i,j}\}$  acts;  $[B_{O1}]_{i,j}$  is the skew-symmetric matrix that is generated from the vector  $\{r_{O1}\}_{i,j}$ .

Vektor vsote sil, ki delujejo na prvi, drugi in tretji element v vsakem zahtevnem elementu druge polovične gredne vezi glede na točko  $O_2$ , je:

The vector of the total force relative to the point  $O_2$  of the forces acting on the first, second and third elements in each complex element of the second half-coupling is:

$$\{F_{O2}\} = -\sum_{i=1}^{NZ} \sum_{j=1}^3 \{F_{i,j}\} \quad (28).$$

Vektor celotnega momenta sil, ki delujejo na prvi, drugi in tretji element v vsakem zahtevnem elementu druge polovične gredne vezi glede na točko  $O_2$ , je:

The vector of the total moment relative to the point  $O_2$  of the forces acting on the first, second and third elements in each complex element of the second half-coupling is:

$$\{M_{O2}\} = -\sum_{i=1}^{NZ} \sum_{j=1}^3 \{r_{O2}\}_{i,j} \times \{F_{i,j}\} = -\sum_{i=1}^{NZ} \sum_{j=1}^3 [B_{O2}]_{i,j} \{F_{i,j}\} \quad (29),$$

kjer so  $\{r_{O2}\}_{i,j}$  koordinate točke, v kateri deluje sila  $\{F_{i,j}\}$ ;  $-[B_{O2}]_{i,j}$  je antisimetrična matrika, ki je dobljena iz vektorja  $\{r_{O2}\}_{i,j}$ .

where  $\{r_{O2}\}_{i,j}$  are the coordinates of the point in which the force  $\{F_{i,j}\}$  acts;  $-[B_{O2}]_{i,j}$  is the skew-symmetric matrix generated from vector  $\{r_{O2}\}_{i,j}$ .

### 1.3 Enačbe gibanja rotorja

### 1.3 Equations of Rotor Motion

Osnovna shema splošnega rotorskega sistema je prikazana v diagramu 1. Rotorski sistem sestoji iz dveh gredi, na katerih sta pritrjeni dve

The principal scheme of a general rotor system is presented in Fig.1. The rotor system consists of shafts, on which half-couplings are

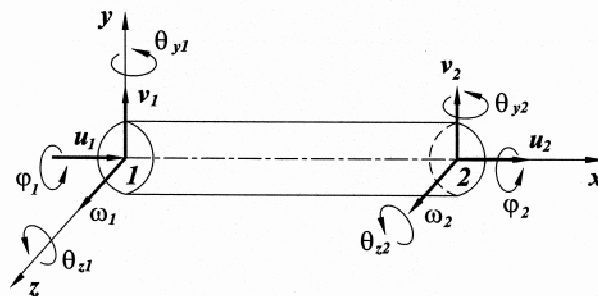

Sl. 4. Palični končni element  
Fig. 4 The beam finite element

polovični gredni vezi; gredi sta podprti z dvema ali več gibkimi oporniki (dušeni ali nedušeni). Vsaka gred je razdeljena v palične končne elemente z naslednjimi lastnostmi: material elementov je homogen z gostoto  $\rho$ , Youngov modul je  $E$  in strižni modul je  $G$ ; intervalno dušenje gredi zanemarimo; prerez je krožen, uporabljena je Bernoulli-Eulerjeva teorija togega (konzolnega) vpetja. Število prostostnih stopenj v vozliščni točki je šest (sl. 4).

Posplošene koordinate paličnih končnih elementov so:

$$\{q\}^T = [u_1, v_1, w_1, \varphi_1, \theta_{y1}, \theta_{z1}, u_2, v_2, w_2, \varphi_2, \theta_{y2}, \theta_{z2}] \quad (30),$$

kjer sta  $q_y, q_z$  kotna premika rotorja:

$$\theta_y = -\frac{dw}{dx}; \quad \theta_z = \frac{dv}{dx}$$

Geometrične značilnosti paličnega končnega elementa so naslednje:  $L$  je dolžina elementa;  $A$  je prerez;  $J_x$  je polarni vztrajnostni moment glede na os  $X$ ;  $J_y, J_z$  sta prečna vztrajnostna momenta glede na osi  $Y, Z$ ;  $J_p$  je polarni vztrajnostni moment;  $J_D$  je prečni vztrajnostni moment.

Kinetično energijo paličnega končnega elementa lahko izrazimo takole:

$$T^{(e)} = \frac{1}{2} \int_0^L \rho A \begin{Bmatrix} \dot{u} \\ \dot{v} \\ \dot{w} \end{Bmatrix}^T \begin{Bmatrix} \dot{u} \\ \dot{v} \\ \dot{w} \end{Bmatrix} dx \quad (31),$$

kjer so  $\dot{u}, \dot{v}, \dot{w}$  premiki glede na osi  $X, Y$  in  $Z$ . Kinetična energija diska je:

$$T_{disk} = \frac{1}{2} \int_0^{L_{disk}} \begin{Bmatrix} \dot{\phi} \\ \dot{\theta}_y \\ \dot{\theta}_z \end{Bmatrix}^T [T_{disk}] \begin{Bmatrix} \dot{\phi} \\ \dot{\theta}_y \\ \dot{\theta}_z \end{Bmatrix} dx \quad (32),$$

kjer je  $L_{disk}$  - dolžina diska;  $[T_{disk}]$  je matrika

$$[T_{disk}] = \rho \begin{bmatrix} J_p & 0 & -J_p \theta_y \\ 0 & J_D & 0 \\ -J_p \theta_y & 0 & J_D \end{bmatrix}$$

mounted, supported by two or more flexible supports (damped or undamped). The shaft is divided into beam finite elements with the following properties: the material of the element is homogeneous, with density  $\rho$ , Young's modulus  $E$  and shear modulus  $G$ ; the interval damping of the shaft is neglected; the cross-section is circular; the theory of Bernoulli-Euler is applied. The number of degrees of freedom at a nodal point is six (Fig. 4).

The generalized coordinates in the beam finite elements are:

where,  $q_y, q_z$  are angular rotor displacements,

The geometrical properties of the beam finite element are as follows:  $L$  is the length of the element;  $A$  is the cross-sectional area;  $J_x$  is the polar moment of inertia with respect to the  $X$  axis;  $J_y, J_z$  are the transverse moments of inertia with respect to the  $Y, Z$  axes;  $J_p$  is the polar moment of inertia;  $J_D$  is the transverse moment of inertia.

The kinetic energy of the beam finite element can be expressed as:

where  $\dot{u}, \dot{v}, \dot{w}$  are displacements with respect to the  $X, Y$  and  $Z$  axes.

The kinetic energy of the disk is:

where  $L_{disk}$  - is the length of the disk;  $[T_{disk}]$  is the matrix



Deformacijsko energijo paličnega elementa lahko izrazimo:

$$\Pi^{(e)} = \frac{1}{2} \int_0^L \left[ EA \left( \frac{du}{dx} \right)^2 + EJ_z \left( \frac{dv}{dx^2} \right)^2 + EJ_y \left( \frac{d^2w}{dx^2} \right)^2 + GJ_p \left( \frac{d\varphi}{dx} \right)^2 + P \left[ \left( \frac{d^2v}{dx^2} \right)^2 + \left( \frac{d^2w}{dx^2} \right)^2 \right] \right] dx \quad (33),$$

kjer je  $P$  vzdolžna obremenitev.

Premiki in kotni premiki rotorja so v približku naslednji:

$$\begin{Bmatrix} u \\ v \\ w \end{Bmatrix} = [N_1] \{q\}, \quad \begin{Bmatrix} \varphi \\ \theta_y \\ \theta_z \end{Bmatrix} = [N_2] \{q\} \quad (34).$$

$$[N_1] = \begin{bmatrix} N_5 & 0 & 0 & 0 & 0 & 0 & N_6 & 0 & 0 & 0 & 0 & 0 \\ 0 & N_1 & 0 & 0 & 0 & N_2 & 0 & N_3 & 0 & 0 & 0 & N_4 \\ 0 & 0 & N_1 & 0 & -N_2 & 0 & 0 & 0 & N_3 & 0 & -N_4 & 0 \end{bmatrix}$$

$$[N_2] = \begin{bmatrix} 0 & 0 & 0 & N_5 & 0 & 0 & 0 & 0 & 0 & N_6 & 0 & 0 \\ 0 & 0 & -\frac{dN_2}{dx} & 0 & \frac{dN_2}{dx} & 0 & 0 & 0 & \frac{dN_3}{dx} & 0 & \frac{dN_4}{dx} & 0 \\ 0 & \frac{dN_1}{dx} & 0 & 0 & 0 & \frac{dN_2}{dx} & 0 & \frac{dN_3}{dx} & 0 & 0 & 0 & \frac{dN_4}{dx} \end{bmatrix}$$

kjer so  $N_i = N_i(x)$  ( $i = 1, 2, \dots, 6$ ) oblikovne funkcije;  $N_1(x), \dots, N_4(x)$  polinomi tretjega reda; in  $N_5(x), N_6(x)$  polinoma prvega reda.

Če v obrazcih za energijo (31) in (32), upoštevamo obrazca (34), dobimo naslednja obrazca za kinetično in deformacijsko energijo paličnega končnega elementa z diskom:

The strain energy of the beam element can be expressed as:

where  $P$  is the axial load.

The displacements and the angular rotor displacements are approximated as follows:

where  $N_i = N_i(x)$  ( $i = 1, 2, \dots, 6$ ) are the shape functions;  $N_1(x), \dots, N_4(x)$  are the third-order polynomials; and  $N_5(x), N_6(x)$  are the first-order polynomials.

Substituting expressions (34) into the energy expressions (31) and (32) gives us the following kinetic and strain-energy expressions for a beam finite element with a disk:

$$T^{(e)} = \frac{1}{2} \{\dot{q}\}^T \left( [M_1^{(e)}] + [M_2^{(e)}(q)] \right) \{\dot{q}\} \quad (35)$$

$$\Pi^{(e)} = \frac{1}{2} \{q\}^T [K^{(e)}] \{q\} \quad (36),$$

kjer je

where

$$[M_1^{(e)}] = \int_0^L \rho A [N_1]^T [N_1] dx \quad (37)$$

$$[M_2^{(e)}(q)] = \int_0^L [N_2]^T [T_{disk}] [N_2] dx \quad (38)$$

$$[K^{(e)}] = \int_0^L \left( [N_3]^T [D] [N_3] \right) dx \quad (39).$$

$$[N_3] = \begin{bmatrix} \frac{dN_5}{dx} & 0 & 0 & 0 & 0 & 0 & \frac{dN_6}{dx} & 0 & 0 & 0 & 0 & 0 \\ 0 & \frac{d^2N_1}{dx^2} & 0 & 0 & 0 & \frac{d^2N_2}{dx^2} & 0 & \frac{d^2N_3}{dx^2} & 0 & 0 & 0 & \frac{d^2N_4}{dx^2} \\ 0 & 0 & \frac{d^2N_1}{dx^2} & 0 & -\frac{d^2N_2}{dx^2} & 0 & 0 & 0 & \frac{d^2N_3}{dx^2} & 0 & -\frac{d^2N_4}{dx^2} & 0 \\ 0 & 0 & 0 & \frac{dN_5}{dx} & 0 & 0 & 0 & 0 & 0 & 0 & \frac{dN_6}{dx} & 0 \end{bmatrix}$$

$$[D] = \text{diag} \left( EA, (EJ_z + P), (EJ_y + P), GJ_p \right) \quad (40).$$

Enačbe gibanja končnega elementa rotorja dobimo z uporabo Lagrangeve enačbe drugega reda in jih lahko prikažemo z matrično enačbo:

The equations of motion of the finite element of the rotor are obtained by using the second-order Lagrange equation, and can be represented by the matrix equation:

$$\left( [M_1^{(e)}] + [M_2^{(e)}(q)] \right) \{\ddot{q}\} + [\dot{M}_2^{(e)}(q)] \{\dot{q}\} + [K^{(e)}] \{q\} = \{F^{(e)}(t, q, \dot{q})\} \quad (41).$$

#### 1.4 Enačbe gibanja sklopke

Učinke vrteče se polovične gredne vezi lahko izpeljemo iz enačb gibanja togega diska. Enačbo kinetične energije sklopke lahko izrazimo:

$$\begin{aligned} T = & \frac{1}{2} \begin{Bmatrix} \dot{q}_1 \\ \dot{q}_2 \\ \dot{q}_3 \end{Bmatrix}^T [T_1] \begin{Bmatrix} \dot{q}_1 \\ \dot{q}_2 \\ \dot{q}_3 \end{Bmatrix} + \frac{1}{2} \begin{Bmatrix} \dot{q}_7 \\ \dot{q}_8 \\ \dot{q}_9 \end{Bmatrix}^T [T_2] \begin{Bmatrix} \dot{q}_7 \\ \dot{q}_8 \\ \dot{q}_9 \end{Bmatrix} + \frac{1}{2} \begin{Bmatrix} \dot{q}_4 \\ \dot{q}_5 \\ \dot{q}_6 \end{Bmatrix}^T [D_1]^T [T_3] [D_1] \begin{Bmatrix} \dot{q}_4 \\ \dot{q}_5 \\ \dot{q}_6 \end{Bmatrix} + \\ & + \frac{1}{2} \begin{Bmatrix} \dot{q}_{10} \\ \dot{q}_{11} \\ \dot{q}_{12} \end{Bmatrix}^T [D_2]^T [T_4] [D_2] \begin{Bmatrix} \dot{q}_{10} \\ \dot{q}_{11} \\ \dot{q}_{12} \end{Bmatrix} = \frac{1}{2} \{\dot{q}\}^T ([M_3] + [M_4(q)]) \{\dot{q}\} \end{aligned} \quad (42),$$

kjer so

$$\begin{aligned} [T_1] &= \text{diag}(m, m_1, m_1) \\ [T_2] &= \text{diag}(J_{p_1}, J_{D_1}, J_{D_1}) \\ [D_1] &= \begin{bmatrix} 1 & 0 & -\theta_{y_1} \\ 0 & 1 & \varphi_1 \\ 0 & -\varphi_1 & 1 \end{bmatrix} \end{aligned}$$

$m_1, m_2$  sta masi prve oziroma druge polovične gredne vezi;  $J_{p_i}, J_{D_i}$  sta masni polarni vztrajnostni moment in masni prečni vztrajnostni moment polovične gredne vezi ( $i = 1, 2$ ).

Enačbe gibanja sklopk dobimo z uporabo Lagrangejeve enačbe drugega reda in jih lahko prikažemo z matrično enačbo:

$$\left( [M_3^{clutch}] + [M_4^{clutch}(q)] \right) \{\ddot{q}\} + [\dot{M}_4^{clutch}(q)] \{\dot{q}\} = \{F^{clutch}(q, \dot{q})\} \quad (43),$$

kjer je  $\{F^{clutch}(q, \dot{q})\}$  nelinearni vektor obremenitve.

#### 1.5 Sistem enačb asinhronnega motorja

Sistem enačb asinhronnega motorja lahko zapišemo kot ([11], [12] in [14]):

$$\{\dot{Z}\} = [A_{asyn}] \{Z\} + \{B_{asyn}(Z, \dot{\varphi}_1)\} \quad (44),$$

kjer sta  $[A_{asyn}]$  in  $\{B_{asyn}(Z, \dot{\varphi}_1)\}$  matrični oziroma vektorski element, ki sta odvisna od rotorske in statorske induktivnosti ter od števila polarnih dvojic;  $\dot{\varphi}_1$  je kotna hitrost rotorja asinhronnega motorja.

Vrtilni moment asinhronnega motorja je nelinearna funkcija elementov vektorja  $\{Z\}$ ,  $M_{asyn}(Z)$ .

#### 1.6 Sistem enačb rotorskega sistema

Splošni matematični model rotorskega sistema lahko oblikujemo po enačbah (44), (41) in (42): sistemov enačb gibanja asinhronnega motorja, rotorjev in sklopk. Splošni sistem enačb lahko

#### 1.4 Equations of Motion of the Clutch

The effects of a rotating half-coupling can be derived from the equations of motion for a rigid disk. The kinetic-energy expression of the clutch can be presented as:

where

$$\begin{aligned} [T_2] &= \text{diag}(m_2, m_2, m_2) \\ [T_3] &= \text{diag}(J_{p_2}, J_{D_2}, J_{D_2}) \\ [D_2] &= \begin{bmatrix} 1 & 0 & -\theta_{y_2} \\ 0 & 1 & \varphi_2 \\ 0 & -\varphi_2 & 1 \end{bmatrix} \end{aligned}$$

$m_1, m_2$  are the mass of the first and the second half-couplings, respectively;  $J_{p_i}, J_{D_i}$  are mass polar inertia moment and transverse inertia moment of half-coupling ( $i = 1, 2$ ).

The equations of motion of the clutches are obtained by using the second-order Lagrange equation and can be represented by the matrix equation:

where  $\{F^{clutch}(q, \dot{q})\}$  is the non-linear load vector.

#### 1.5 System of Equations of the Asynchronous Engine

The system of equations of the asynchronous engine can be written as ([11], [12] and [14]):

where  $[A_{asyn}]$  and  $\{B_{asyn}(Z, \dot{\varphi}_1)\}$  are the matrix and vector elements that depend on rotor and stator inductivities, and the number of pole pairs;  $\dot{\varphi}_1$  is the angular velocity of the rotor of an asynchronous engine.

The torque of an asynchronous engine is a non-linear function of the elements of the vector  $\{Z\}$ ,  $M_{asyn}(Z)$ .

#### 1.6 System of Equations of the Rotor System

A general mathematical model of the rotor system can be constructed from (44), (41) and (42): the systems of equations of motion of an asynchronous engine, the rotors and the clutch,

prikažemo takole:

$$[M(Y)]\{\ddot{Y}\} + [C(Y)] + [K]\{Y\} = \{F(t, Y, \dot{Y})\} \quad (45),$$

kjer so

$$[M(Y)] = \begin{bmatrix} [0] & [0] \\ [0] & [M_q(q)] \end{bmatrix}$$

$$[K] = \begin{bmatrix} -[A_{asyn}] & [0] \\ [0] & [K_q] \end{bmatrix}$$

$[E]$  je enotna matrika  $4 \times 4$ .

Poznamo mnogo metod, ki jih lahko uporabimo za numerično časovno integracijo sistema enačb (45). Na splošno lahko te metode klasificiramo kot izrecne ali posredne sheme ([15] in [16]). Izrecne sheme so preproste z računskega vidika, a dolžina njihovega časovnega intervala je odvisna od stabilnosti sistema. Posredne sheme zahtevajo več preračunavanja za posamezni časovni korak, a njihove omejitve dolžine časovnega koraka niso tako stroge. Uporabljali smo posredno shemo, osnovano na trapeznem pravilu. Ob predpostavki, da so vse spremenljivke v enačbi (45) znane za čas  $t_k$ , smo trapezno pravilo za ta primer razvili takole:

$$\{Y\}_{k+1} = \{Y\}_k + \frac{\Delta t}{2} (\{\dot{Y}\}_k + \{\dot{Y}\}_{k+1}), \quad \{\dot{Y}\}_{k+1} = \{\dot{Y}\}_k + \frac{\Delta t}{2} (\{\ddot{Y}\}_k + \{\ddot{Y}\}_{k+1}) \quad (46)$$

in če združimo obrazca (46), dobimo vektor pospeška za čas  $t_{k+1}$ :

$$\{\ddot{Y}\}_{k+1} = \frac{4}{\Delta t^2} (\{Y\}_{k+1} - \{Y\}_k) - \frac{4}{\Delta t} \{\dot{Y}\}_k - \{\ddot{Y}\}_k \quad (47).$$

Z upoštevanjem formul (46) in (47) v sistemu enačb (45) dobimo sistem nelinearnih algebrskih enačb:

$$[\Phi(\{Y\}_{k+1})] = 0 \quad (48).$$

Dobljeni sistem nelinearnih algebrskih enačb (48) smo rešili z uporabo Newtonove metode ([11] do [14]).

## 2 NUMERIČNI REZULTATI

Preučili smo rotorski sistem z gibko sklopko in neporavnanimi grednima osema. Sklopka sestoji iz prosto nameščenih obročev (zahtevni element), čigar osi ležijo pravokotno na os sklopke (sl. 5).

Izračunali smo prečne togosti sklopke in izdelali krivulje pospeškov sil za različne vrednosti neporavnanimi grednih osi ( $e$ ) ter različna števila obročev ( $NZ$ ) (sl. 6).

respectively. A general system of equations can be represented as follows:

where

$$[C(Y)] = \begin{bmatrix} [E] & [0] \\ [0] & [C_q(q)] \end{bmatrix}$$

$$\{F(t, Y, \dot{Y})\} = \begin{Bmatrix} \{B(Z, \dot{q})\} \\ \{F(Z, q, \dot{q})\} \end{Bmatrix}$$

$[E]$  is the  $4 \times 4$  identity matrix.

There are many methods that can be used for the numerical time integration of a system of equations (45). Generally speaking, these methods can be classified as either explicit or implicit schemes ([15] and [16]). Explicit schemes are computationally simple but the time-step size is limited by stability considerations. Implicit schemes require more computation per time step, but time-step size limitations are much less stringent. We have used an implicit scheme based on the trapezoidal rule. Assuming all the variables in equation (45) are known at time  $t_k$ , the trapezoidal rule for this problem is:

and combining expressions (46), we obtain the vector of acceleration at time  $t_{k+1}$ :

Substituting expressions (46) and (47) into the system of equations (45) we obtain a non-linear algebraic system of equations:

The obtained system of nonlinear algebraic equations (48) was solved using Newton's method ([11] to [14]).

## 2 NUMERICAL RESULTS

A rotor system with a flexible clutch and the misalignment of the shaft axes was investigated. The clutch consists of freely located rings (complex element), the axes of which are perpendicular to the axis of the clutch (Fig.5).

The radial rigidities of the clutch were calculated and hodographs of the forces for various values of misalignment of the shaft axes ( $e$ ) and different numbers of rings ( $NZ$ ) (Fig. 6) were constructed.

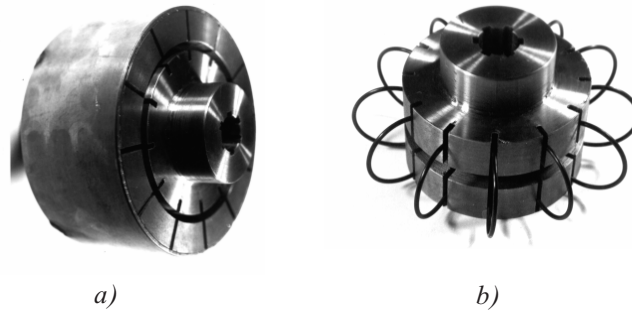

Sl. 5. Gonilna polovična gredna vez z obroči, nameščenimi v režah  
 a – celovit prikaz, b – gonilna polovična sklopka z obroči, nameščenimi v režah  
 Fig.5 Driving half-coupling with rings located in slits  
 a – general view, b – driving half-clutch with rings located in slits

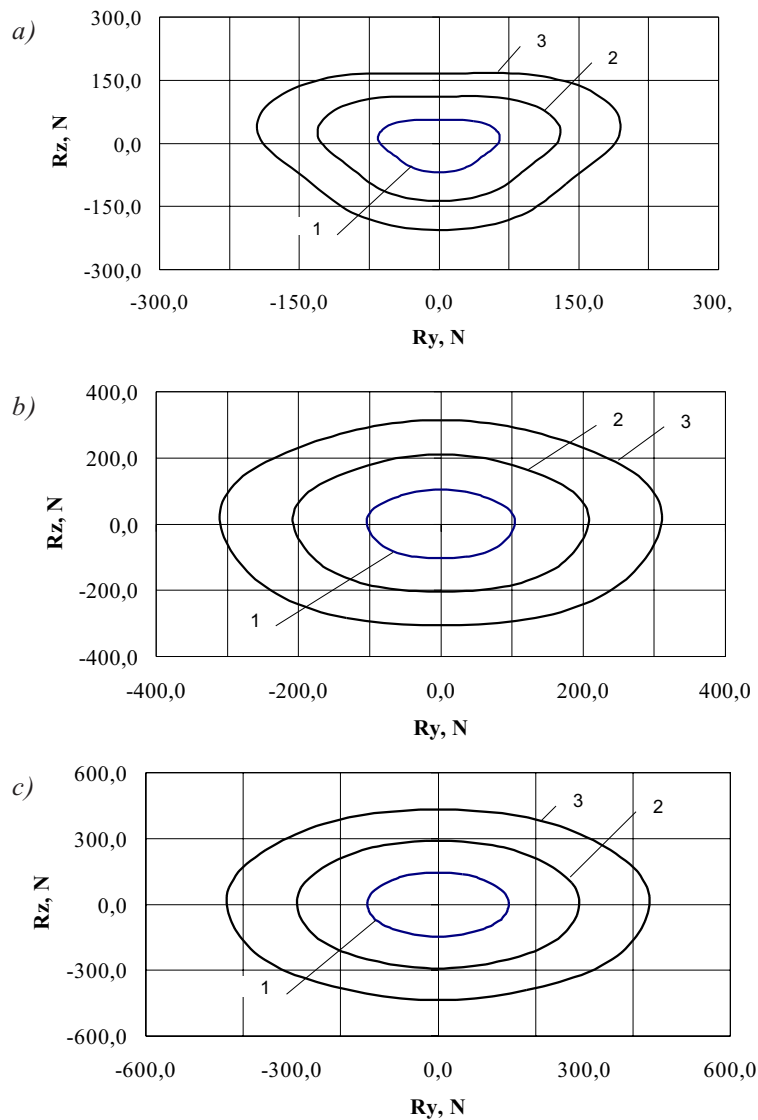

Sl. 6. Krivulje pospeškov togosti prečnih sil: sklopka s spremenljivim številom obročev (NZ) in neporavnanošjo grednih osi(e):

Fig. 6. Stiffness hodographs of the radial forces: the clutch with a variable number of rings (NZ) and misalignment of the shaft axes(e):

$$\begin{aligned}
 &a - NZ = 3; b - NZ = 5; c - NZ = 7; 1 - e = 0,5 \text{ mm}; 2 - e = 1,0 \text{ mm}; 3 - e = 1,5 \text{ mm}; r_{21} = 0,09 \text{ m}; \\
 &a_{1x} = a_{1y} = 0,025 \text{ m}; a_{1z} = 0,01 \text{ m}; b_{1x} = b_{2x} = 0,025 \text{ m}; a_{2x} = a_{1x}; a_{2y} = a_{1y}; a_{2z} = a_{1z}; \\
 &k_{1,i,2i} = k_{1,2,i} = k_{3,4,i} = 10^5 \text{ N/m}; i = 1 \dots NZ
 \end{aligned}$$

Slika 6 kaže, da so radialne sile večje pri večji neporavnosti grednih osi, kadar imajo povezovalni obroči enake prečne togosti. Poleg tega se sile prečnih togosti povečajo in se oblika krivulje pospeškov togosti prečnih sil približa obliki kroga, kadar se poveča tudi število obročev ( $NZ$ ), ki povezujejo gonilno in gnano polovično gredno vez.

Prečna togost sklopke se periodično spremeni glede na število zahtevnih elementov (obročev) ( $NZ$ ) in frekvenco vrtenja gredi ( $\omega$ ). Frekvenca prečne togosti ( $\Omega$ ) je enaka:

$$\Omega = \frac{NZ \cdot \omega}{2\pi} \quad (49).$$

Kadar se sistem vrti, se lahko pojavijo parametrične vibracije. Da bi zmanjšali pojav parametričnih vibracij, moramo povečati frekvenco prečne togosti sklopke tako, da le-ta ni v fazi s frekvenco vrtenja gredi. Frekvenca prečne togosti sklopke se poveča s povečanim številom elastičnih elementov ( $NZ$ ), vendar mora biti povečanje  $NZ$  zmerno, sicer bo sklopka toga, kar pa ni zaželeno. Lahko povečamo tudi število zahtevnih elementov ( $NZ$ ), s čimer zmanjšamo njihovo prečno togost. V tem primeru se približamo bandažni sklopki z izboljšanimi značilnostmi vrtilnega gibanja. Ker so takšne sklopke bolj zanesljive, so njihove obratovalne značilnosti primerljive z značilnostmi gumenih (bandažnih) sklopok. [9].

Naš model vključuje rotorski sistem, ki sestoji iz asinhronnega motorja (4A100/4SY3), dveh gredi in gredne vezi, narejene iz dveh polovičnih grednih vezi in sedmih zahtevnih elementov (obročev) – sl. 7.

Premera in dolžini obeh gredi so  $d_1 = d_2 = 0,040$  m in  $L_1 = L_2 = 1,0$  m; vztrajnostna momenta mas polovičnih grednih vezi sta  $I_{p1} = I_{p2} = 0,624$  kgm<sup>2</sup>;  $I_{D1} = I_{D2} = 0,312$  kgm<sup>2</sup>;  $k_i = 10^6$  N/m;  $h_i = 10^3$  Ns/m; ( $i = 1, 2, \dots, 8$ ). Obremenitveni moment je  $M_{load} = 10$  Nm. Časovna odvisnost premika prve polovične gredne vezi v smeri osi  $Y$  je prikazana na sliki 8, odvisnost amplitude premika od frekvence pa je podana na sliki 9.

Fig. 6 shows that when the connecting rings are of the same radial rigidities, the radial forces are larger for larger misalignments of the shaft axes. In addition, the forces of the radial rigidities increase and the shape of the stiffness hodograph of the radial forces approaches that of a circle when the number ( $NZ$ ) of rings connecting the driving and the driven half-couplings is increased.

The radial stiffness of the clutch changes periodically according to the number of complex elements (rings) ( $NZ$ ) and the frequency of the shaft rotation ( $\omega$ ). The frequency of radial stiffness ( $\Omega$ ) is equal to:

When the system rotates, parametric vibrations can occur. To reduce the occurrence of parametric vibrations, it is necessary to increase the frequency of the clutch radial stiffness in such a way that it is not in phase with the frequency of shaft rotation. But the frequency of the clutch radial stiffness increases with an increasing number of elastic elements ( $NZ$ ). However, the increase in  $NZ$  must be moderate, because, otherwise, we will have a stiff clutch, which is undesirable. One can also increase the number of complex elements ( $NZ$ ), simultaneously decreasing their radial stiffness. In such a case, we approach a tyre-type clutch with improved characteristics of rotational motion. As such clutches are much more reliable, their operational characteristics are better compared with rubber (tyre-type) clutches [9].

A rotor system consisting of an asynchronous engine (4A100/4SY3), two shafts and a coupling made of two half-couplings and seven complex elements (rings) (Fig.7) is considered.

The diameters and the lengths of both shafts are equal to  $d_1 = d_2 = 0.040$  m and  $L_1 = L_2 = 1.0$  m, the inertia moments of the half-couplings' masses are  $I_{p1} = I_{p2} = 0.624$  kgm<sup>2</sup>;  $I_{D1} = I_{D2} = 0.312$  kgm<sup>2</sup>;  $k_i = 10^6$  N/m;  $h_i = 10^3$  Ns/m; ( $i = 1, 2, \dots, 8$ ). The load moment  $M_{load} = 10$  Nm. The dependence of the displacement of the first half-coupling in the direction of the  $Y$  axis on time is shown in Fig. 8, while the dependence of the displacement amplitude on frequency is given in Fig.9.

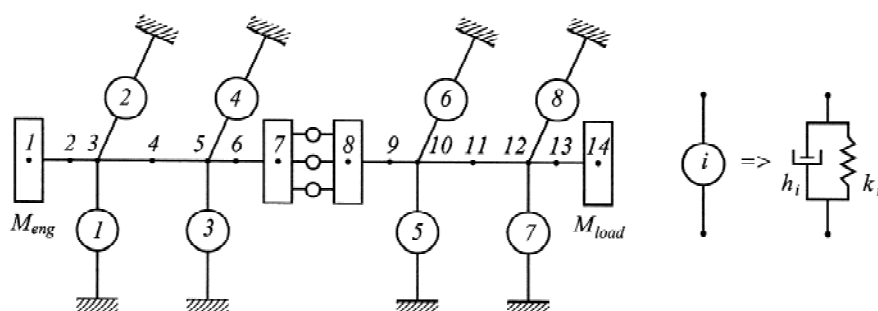

Sl. 7. Shema rotorskega sistema  
Fig. 7. A scheme of the rotor system

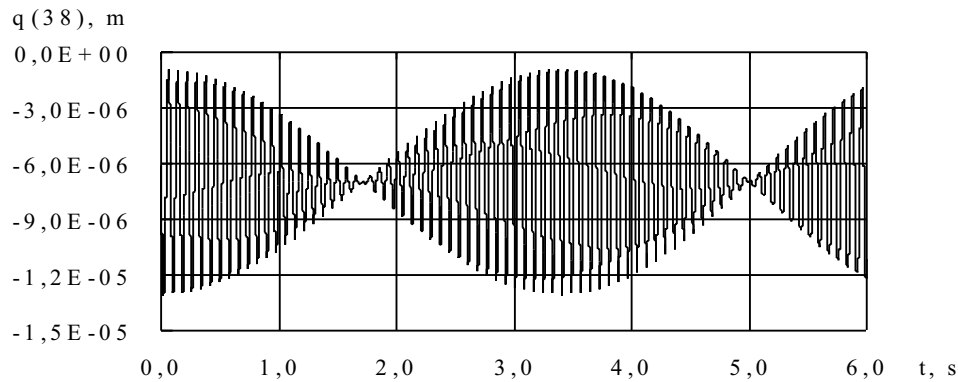

Sl. 8. Časovna odvisnost premika  $q_{38}$  prve polovične gredne vezi v smeri osi Y  
 Fig. 8. The dependence of the displacement  $q_{38}$  of the first half-coupling in the direction of the Y axis on time

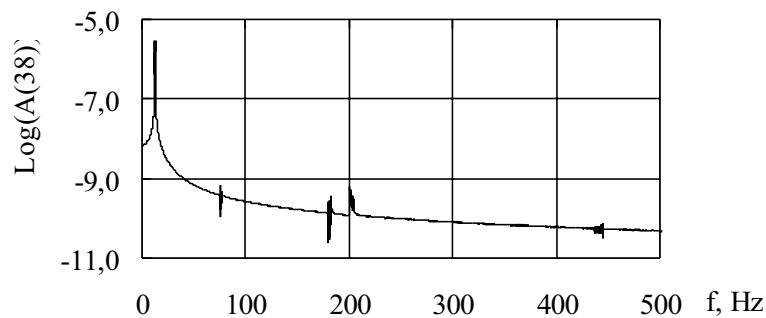

Sl. 9. Odvisnost amplitude premika  $q_{38}$  od frekvence  
 Fig. 9 The dependence of the displacement  $q_{38}$  amplitude on frequency

### 3 SKLEPI

1. Naš dinamični model rotorskega sistema z gibko, centrifugalno gredno vezjo opiše prostorska, geometrična, tehnološka in konstrukcijska odstopanja pa tudi dinamične posebnosti.
2. Z modelom lahko ovrednotimo sistem z želenim številom prostostnih stopenj na naslednje načine:
  - s povezovanjem koordinat začetnega sistema z ustreznimi koordinatami deformiranega sistema, pri čemer uporabljamo matematične odvisnosti;
  - s prikazom medsebojnih odnosov med začetnimi in deformiranimi točkami v različnih koordinatnih smereh;
  - s prikazom matematičnega odnosa med silami sestavljenih elementov rotorskega sistema in momentih, pa tudi njihov vpliv na gredi in oporne dele;
  - z določitvijo kinetične in potencialne energije kinematičnih in dinamičnih parametrov deformiranega sistema, lege in oblike elastičnih grednih vezi, ki povezujeta sistem.

### 3 CONCLUSIONS

1. Our dynamic model of a rotor system with a flexible, centrifugal coupling describes the spatial, the geometrical, the technological and the constructional deviations as well as the dynamic peculiarities.
2. The model can evaluate the system with a desired number of degrees of freedom in the following ways:
  - Connecting the initial system's coordinates with the corresponding coordinates of the deformed system using mathematical dependences;
  - Showing the interrelations of the initial and deformed points in various directions of the coordinates;
  - Showing a mathematical relation between the forces of the rotor system's composite elements and the moments, as well as their influence on the shafts and the supporting parts;
  - Finding the kinetic and potential energies of the deformed system's kinematic and dynamic parameters, and the position and the shape of the elastic couplings connecting the system.

### 4 LITERATURA 4 REFERENCES

- [1] Bert, C.W., S. Wu (2003) Dynamic analysis of a nonlinear torsional flexible coupling with elastic links. *Journal of Mechanical Design*. Vol.125, Issue 3, 509-517.

- [2] Mohiuddin, M.A., Y.A. Khulief (2002) Dynamic response analysis of rotor-bearing systems with cracked shaft. *Journal of Mechanical Design*. Vol.124, Issue 4, 690-696.
- [3] Domachowski, Z., W. Prochnicki, Z. Puhaczewski, M. Dzida (2003) Influence of control loop on torsional vibrations of rotating machinery. *The 2<sup>nd</sup> International Symposium on Stability Control of Rotating Machinery*. Gdansk-Poland, 4-8 August 2003, 122-129.
- [4] Spruogis, B. (1997) The devices of transmission and stabilization of rotary motion. *V.: Technika*, 476 p. (v ruskem jeziku).
- [5] Bogdevičius, M., B. Spruogis (1996) Theoretical investigations into rotary systems with elastic link caused by the deflection of the shafts. *Transportas (Transport Engineering)*. *V.: Technika*, No2(13), 70-81 (v ruskem jeziku).
- [6] Spruogis, B. (1994) The counting of elements of rotary motion transmission and their parameters optimisation. *Taikomoji mechanika (Applied Mechanics)*. *Kaunas: Technologija*, No2. 99-105 (v litovskem jeziku).
- [7] Bogdevičius, M., B. Spruogis (1997) Dynamic and mathematical models of rotor system with elastic link in the presence of shafts misalignment. 2<sup>nd</sup> International Conference of Mechanical Engineering "Mechanics'97". *Proceedings. Part 1. V.: Technika*, 78-84.
- [8] Ragulskis, K., B. Spruogis, M. Ragulskis (1999) Transformation of rotational motion by inertia couplings. *Vilnius: Technika*, 236 p.
- [9] Spruogis, B. (1998) Rotary systems motion stabilization devices. Science and Arts of Lithuania. *Vibroengineering. Vilnius: Lithuania*, 452-465.
- [10] Adiletta, G. and A.R. Guido (2000) Dynamical behaviour of a torsional system with parametric and external excitations. *Journal of Mechanical Engineering Science. Proceedings part C*. Vol. 214 NoC7. 955-973.
- [11] Bogdevičius, M. (2000) Simulation of dynamic processes in hydraulic, pneumatic and mechanical drivers and their elements. *Vilnius: Technika*, 96 p.
- [12] Aladjev, V., M. Bogdevičius (2001) Maple 6: Solution of the mathematical, statistical and engineering – physical problems. *Moscow: Laboratory of Basic Knowledges*, 824 (v ruskem jeziku).
- [13] Aladjev, V., M. Bogdevičius, O. Prentkovskis (2002) New software for mathematical package maple of releases 6, 7 and 8. *Vilnius: Technika*, 404 p.
- [14] Bogdevičius, M. (2002) Simulation of dynamic processes in mechanical drive with coupling gas. *Proceedings of the Six International Conference on Motion and Vibration Control*, August 19-23, Saitama, Japan, 543-546.
- [15] Goudreau, G.L., R.L. Taylor (1973) Evaluation of numerical integration methods in elastodynamics. *Computer Methods in Applied Mechanics and Engineering*. Vol. 2, 69-97
- [16] Fellipa, C.A., K.C. Park (1979) Direct time integration methods in nonlinear structural dynamics. *Computer Methods in Applied Mechanics and Engineering*. Vol. 17, 277-313.

Naslova avtorjev: prof. dr. Marijonas Bogdevičius  
prof. dr. Bronislovas Spruogis  
Fakulteta za transportno tehniko  
Tehnična univ. Vilnius Gediminas  
Sauletekio al. 11  
LT-2040 Vilnius, Litva  
marius@ti.vtu.lt

doc. dr. Vytautas Turla  
Fakulteta za mehaniko  
Tehnična univ. Vilnius Gediminas  
J. Basanavicius str. 28  
LT-2006 Vilnius, Litva  
pgkatedra@me.vtu.lt

Authors' Addresses: Prof.Dr. Marijonas Bogdevičius  
Prof.Dr. Bronislovas Spruogis  
Faculty of Transport Eng.  
Vilnius Gediminas Tech. Univ.  
Sauletekio al. 11  
LT-2040 Vilnius, Lithuania  
marius@ti.vtu.lt

doc. dr. Vytautas Turla  
Mechanical Faculty  
Vilnius Gediminas Tech. Univ.  
J. Basanavicius str. 28  
LT-2006 Vilnius, Lithuania  
pgkatedra@me.vtu.lt

Prejeto: 28.7.2003  
Received:

Sprejeto: 30.9.2004  
Accepted:

Odrpto za diskusijo: 1 leto  
Open for discussion: 1 year