

Obnavljanje curka plinskega olja

Diesel-Spray Analysis

Martin Volmajer - Breda Keglj

V prispevku je obravnavan proces vbrizgavanja goriva in karakteristike curka dizelskega motorja z uporabo programa računske dinamike tekočin FIRE. Natančnost rezultatov, dobljenih s tem programom, je v veliki meri odvisna od pravilno postavljenih začetnih pogojev. Določevanje nekaterih pogojev je precej zahtevno, saj jih lahko določimo le na temelju izkušenj ali zahtevnih meritev v laboratoriju. V tem prispevku so na podlagi številnih zgledov in primerjav z rezultati, dobljenimi z znanimi empiričnimi izrazi za srednji Sauterjev premer kapljic, podane smernice za postavljanje začetnih pogojev.

© 2001 Strojniški vestnik. Vse pravice pridržane.

(Ključne besede: motorji dizelski, šobe za vbrizgavanje, karakteristike curka, računska dinamika tekočin)

The fuel injection process and the characteristics of the diesel-fuel spray were simulated using a computational fluid dynamics program FIRE. Initial conditions greatly influenced the accuracy of the results and these conditions can generally only be determined by complicated laboratory measurements. Guidelines to determine more realistic initial conditions based on comparisons of different practical results and empirical expressions for Sauter's mean diameter of a droplet are given in the paper.

© 2001 Journal of Mechanical Engineering. All rights reserved.

(Keywords: diesel engine, fuel injection nozzles, spray characteristics, computational fluid dynamics)

0 UVOD

Sodoben dizelski motor mora ustrezati ekološkimi in ekonomskim zahtevam. V prvi vrsti mora zagotoviti visoko razmerje med zmogljivostmi in porabo goriva, poceni vzdrževanje ter nenazadnje obratovanje v skladu z vedno strožjimi zakonskimi omejitvami glede največjih dovoljenih emisij produktov zgorevanja.

Glede na to, da sta proces zgorevanja in tvorba nezaželenih sestavin ostankov zgorevanja v glavnem vodena s procesom vbrizgavanja in tvorbo curka razpršenega goriva, se veliko vlaga v razvoj novih oziroma izboljšavo sedanjih vbrizgalnih sistemov in analizo curka razpršenega goriva.

V zadnjih letih pridobivajo pomen analize z uporabo programov računske dinamike tekočin (RDT - CFD), saj predstavljajo razmeroma preprost način analiziranja procesov vbrizgavanja pri novih, pa tudi spremenjenih sedanjih vbrizgalnih sistemih. Z uporabo paketov RDT lahko prihranimo precej časa namenjenega izdelavi in testiranju vbrizgalnih sistemov. S simuliranjem procesa na računalniku lahko v razmeroma kratkem času testiramo veliko število različic ter tako že v začetni fazi izločimo tiste, ki ne prinašajo želenih rezultatov.

0 INTRODUCTION

A modern compression-ignition engine should meet ecological and economic requirements. First of all it should have a high ratio of performance to fuel consumption, low maintenance costs and it should be able to operate within prescribed emission regulations.

As the process of combustion and the resulting emission of pollutants and noise is mainly affected by the process of fuel injection, a lot of effort is put into developing new or improving existing fuel-injection systems as well as into the analysis of the fuel spray.

In recent years, analysis using computational fluid dynamics (CFD) programs became important since this is a relatively easy way to analyse fuel-injection processes in new or re-designed fuel-injection systems. Using CFD programs, a lot of the manufacturing and experimental work is unnecessary, since there is no need to produce every design variant. Many variants can be tested using a simulation on the computer. Those variants that show no significant improvement can be eliminated at an early stage.

V avtomobilski industriji se uporablja več računalniških paketov računske dinamike tekočin. Eden izmed teh je program FIRE izdelovalca AVL. FIRE uporablja metodo končnih prostornin za analiziranje toka tekočine. Glede na to, da je v prvi vrsti namenjen avtomobilski industriji oziroma uporabi na motorjih z notranjim zgorevanjem, vključuje tudi modula za simuliranje curka razpršene tekočine in procesov zgorevanja [1].

Uporaba tega modula in s tem določitev začetnih pogojev zahteva dobro poznavanje in razumevanje procesov tvorbe curka goriva. Izmere šobe in začetni pogoji se pred začetkom analize definirajo v t.im. "spray" datoteki. Zraven določite preprosto merljivih oz. znanih vrednosti, kakor so: geometrijska oblika šobe (število šob in odprtih šob, koti porazdelitve odprtih itn.), karakteristika vbrizgavanja ter količina vbrizganega goriva, je treba definirati tudi parametre, ki jih lahko v veliki večini določimo le na temelju ocen oziroma izkušenj. To so: velikost kapljic in verjetnostna porazdelitev kapljic, ki določa verjetnost, da se kapljica z določenim premerom pojavi v zgorevalni komori, ter kot pri vrhu stožca in radialna komponenta hitrosti iztekanja goriva iz šobe, ki določata obliko stožca.

Natančna določitev omenjenih začetnih pogojev zahteva drago eksperimentalno opremo. Za razmeroma natančno določitev pa pogosto zadostuje že dobro poznavanje procesa vbrizgavanja in tvorbe curka. V ta namen smo se odločili, da z analiziranjem različnih primerov vbrizgavanja ugotovimo, kako omenjeni začetni pogoji vplivajo na izračunano velikost kapljic v komori. Hkrati smo izračunane vrednosti primerjali z rezultati, dobljenimi na podlagi znanih empiričnih izrazov za izračun d_{32} .

1 KARAKTERISTIKE CURKA GORIVA

Pri procesu zgorevanja v dizelskem motorju dovajamo gorivo v zgorevalni prostor v obliki curka skozi šobo z eno ali več odprtin. Strnjeni valjasti curek, ki z veliko tlačno razliko izstopa iz odprtine v valj v neki končni dolžini-dolžini trganja, razpade na kapljice različnih velikosti. V trenutku, ko tekočina zapusti odprtino, se poveča količina zraka v curku, curek se cepi in širi, hitrost gibanja iztekajoče se tekočine pa se s tem zmanjšuje. Največjo dolžino, ki jo prepotujejo kapljice, imenujemo domet curka. Curek vbrizganega goriva v dizelskem motorju ima običajno stožčasto obliko s kotom θ pri vrhu stožca. Takšen način razpada curka imenujemo atomizacija [2].

Navedene veličine pomenijo makroskopske veličine curka, ki predstavljajo porazdelitev goriva po celotnem zgorevalnem prostoru, medtem ko velikost kapljic oziroma kakovost razpršitve curka pomeni mikroskopsko veličino. Običajno so mikro karakteristike curka podane s porazdelitvenimi funkcijami, te pomenijo verjetnost pojavljanja kapljice z določenim premerom. V praktičnih primerih se

The automotive industry uses many different CFD packages. FIRE, which was produced by AVL Graz, uses the finite-volume method for the analysis of the fluid flow characteristics. As it is mainly used by the automotive industry internal combustion engines, it also includes the spray (two-phase flow) and combustion modules [1].

To use the spray module we must begin with appropriate initial conditions and have an understanding of fuel-spray formation. Nozzle dimensions and the initial conditions are defined prior to the investigation in the so-called Spray file. Besides setting the measured or otherwise known values such as nozzle geometry (number of nozzle holes, nozzle hole angles, etc.), injection characteristics and quantity of the injected fluid, other parameters that depend on estimations or experiences must also be set. These parameters are the initial droplet dimensions, the initial droplet probability distribution defining the probability of certain droplet dimension appearing, and the radial velocity of the fuel outflow from the nozzle hole, by which the spray cone angle is defined.

To exactly define the above-mentioned initial conditions requires expensive experimental equipment, often these values can be known only by understanding the full background of the fuel-injection and spray-atomisation processes. The purpose of this study was to establish how the initial conditions affect the mean value of the calculated droplet diameter in the chamber. The values calculated using the CFD package were subsequently compared with the results from the empirical equations for the calculation of d_{32} .

1 FUEL-SPRAY CHARACTERISTICS

The fuel is introduced into the combustion chamber of a Diesel engine through one or more nozzles or orifices. The liquid column leaving the nozzle hole under high pressure, disintegrates within the cylinder over a finite length called the break-up length. As the liquid moves away from the nozzle the mass of air within the spray increases, the spray then diverges, its width increases, and its velocity decreases. The maximum length the droplets travel is called the spray-tip penetration. Diesel-fuel spray usually has a conical shape with an angle θ . This type of disintegration is called atomisation [2].

The quantities presented above are the macroscopic parameters of the spray, representing the fuel distribution in the combustion chamber. At the other side the droplet size, i.e. quality of the atomisation, represents the microscopic parameters. These microscopic parameters are usually defined with probability functions, defining the probability of the appearance of a droplet with a certain diameter. It is usual to use droplet mean diameters rather than

namesto porazdelitvenih funkcij uporabljajo srednji premeri kapljic [2]:

$$d_{jk} = \frac{\int_{d_{\min}}^{d_{\max}} d^j dN}{\int_{d_{\min}}^{d_{\max}} d^k dN} \quad (1)$$

kjer sta N - število kapljic, d - premer kapljice. Najpogosteje se pri procesih vbrizgavanja uporablja Sauterjev srednji premer:

$$d_{32} = \frac{\sum_i N_i d_i^3}{\sum_i N_i d_i^2} \quad (2)$$

ki pomeni razmerje med celotno prostornino in površino kapljic. Za izračun d_{32} obstajajo številni empirični izrazi, med katerimi so najpogosteje uporabljeni empirični izrazi naslednjih avtorjev: [3] en. (3), [4] en. (4), [5] en. (5), [6] en. (6), [7] en. (7) in (8):

$$d_{32} (\mu\text{m}) = 2,39 \cdot 10^{-3} \cdot \Delta p^{-0,135} \cdot \rho_a^{0,121} \cdot q_{cikel}^{0,31} \quad (3)$$

$$d_{32} (\text{mm}) = \frac{585000}{u_0 - u_a} \left(\frac{\sigma_f}{\rho_f} \right)^{0,5} \quad (4)$$

$$d_{32} (\text{mm}) = 124,77 \left(\frac{d_h}{u_0} \right) \left(\frac{\sigma_f}{\rho_a} \right)^{0,25} \left(1 + \frac{3,31 \mu_f}{\sqrt{\sigma_f \rho_f d_h}} \right) \quad (5)$$

$$d_{32} (\mu\text{m}) = 3 \cdot 10^5 \Delta p^{-0,458} G_f^{0,209} v_f^{0,216} \left(\frac{A_d}{A_{d,ef}} \right)^{0,916} \quad (6)$$

$$d_{32} (\mu\text{m}) = 324,6 \left(\frac{\rho_a u_0^2 d_h}{\sigma_f} \right)^{-0,233} \left(\frac{\rho_f d_h \sigma_f}{\mu_f^2} \right)^{-0,082} \quad (7)$$

$$d_{32} (\mu\text{m}) = 6156 v_f^{0,385} \sigma_f^{0,737} \rho_f^{0,737} \rho_a^{0,06} \Delta p^{-0,54} \quad (8)$$

kjer so: Δp - tlačni padec, q_{cikel} - količina vbrizganega goriva na cikel, G_f - pretok goriva, u_0 - hitrost na izstopu iz šobe, u_a - hitrost gibanja zraka, ρ_f - gostota goriva, ρ_a - gostota zraka, σ_f - površinska napetost goriva, μ_f - dinamična viskoznost goriva, v_f - kinematična viskoznost goriva, d_h - premer odprtine šobe, A_d - prerez odprtine šobe in $A_{d,ef}$ - efektivni prerez odprtine šobe. Vse vrednosti se vstavljajo v enotah SI, razen v en. (5) d_h v mm, en.(6) G_h v kg/h in v en.(8) Δp v bar.

2 ŠTEVILČNI PRIMERI

Analiza curka je narejena z uporabo programa FIRE v62b na delovni postaji Hawlett Packard. Proces vbrizgavanja oz. curek je obravnavan na tridimenzionalnem modelu v obliki valja (pregl. 1), ki predstavlja zgorevalno/vbrizgalno komoro. Šoba je postavljena v središče zgornje ploskve valja. Analiza je izvedena na šobah s štirimi odprtinami ($4 \times 0,35$ mm, $4 \times 0,25$ mm in $4 \times 0,40$ mm). Lega šobe in izmere so predstavljeni na sliki 1 in v preglednici 2.

probability functions. The droplet mean diameter is defined as [2]:

where N is the number of droplets and d is the droplet diameter. For fuel-injection processes we usually choose the Sauter mean diameter:

which is defined as the ratio of the sum of the droplets' volumes to the sum of the droplets' surfaces. For the calculation of d_{32} several empirical equations were presented by different authors. Some commonly used examples are: [3] eq. (3), [4] eq. (4), [5] eq. (5), [6] eq. (6), [7] eq. (7) and (8):

where: Δp is the pressure difference, q_{cikel} is the quantity of fuel injected per cycle, G_f is the fuel flow, u_0 is the velocity at the nozzle outflow, u_a is the air velocity, ρ_f is the fuel density, ρ_a is the air density, σ_f is the surface tension of the fuel, μ_f is the dynamic viscosity of the fuel, v_f is the cinematic viscosity of the fuel, d_h is the nozzle hole diameter, A_d is the nozzle hole cross-sectional area and $A_{d,ef}$ is the effective nozzle hole cross-sectional area. All values are in the SI system, except in eq. (5), where d_h is in mm, eq.(6), where G_h is in kg/h and in eq.(8), where Δp is in bar.

2 NUMERICAL EXAMPLES

Spray analyses were made on a HP workstation using the CFD program FIRE (v62b). Fuel-injection, i.e. spray behaviour, was analysed in a three-dimensional cylindrical mesh model (dimensions see tab.1), representing the combustion/injection chamber. The nozzle is positioned at the centre of the upper cylinder plane. Analyses were made for the three different types of four-hole nozzles (4×0.35 mm, 4×0.25 mm, 4×0.40 mm). The position and dimensions of the nozzles are presented in Fig.1 and Tab.2.

Preglednica 1. Izmere komore in začetni pogoji v komori

Table 1. Chamber dimensions and initial conditions

Premer komore Chamber diameter	Višina komore Chamber height	Št. elementov No. volumes	Število vozlišč No. nodes	T_{komore} $T_{chamber}$	p_{komore} $p_{chamber}$
300 mm	150 mm	38808	35301	293 K	1 bar

Preglednica 2. Izmere šobe, karakteristike goriva in vbrizgavanja

Table 2. Nozzle dimensions, fuel and spray characteristics

Premer odprtine šobe Nozzle hole diameter			Naklonski kot šobe Nozzle inclination angle	Količina vbrizganega goriva Inj. fuel quantity	t_{vbrizg} $t_{inj.}$	T_{goriva} T_{fuel}	Gorivo Fuel
Šoba A Nozzle A	Šoba B Nozzle B	Šoba C Nozzle C					
0,35 mm	0,25 mm	0,40 mm	38,5°	151,6 mm ³	0,002 s	313 K	D2

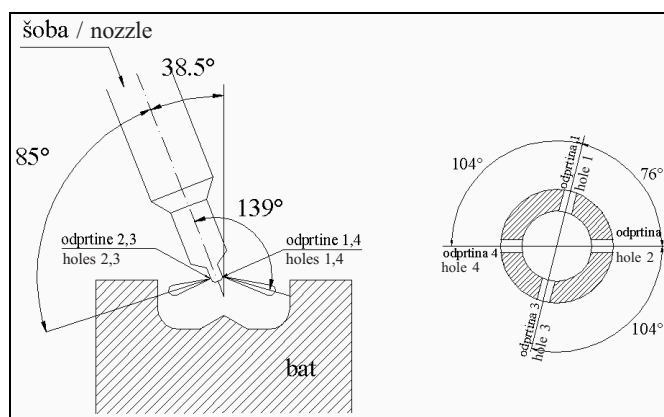

Sl. 1. Nagibni koti šobe, odprtin šobe in razporeditev odprtin

Fig. 1. Nozzle inclination angle, nozzle holes inclination angles, nozzle hole distribution

V prvem primeru smo primerjali potek vbrizgavanja in oblikovanja curka na šobi A za tri različne začetne vrednosti Sauterjevega premera z enakim potekom krivulje porazdelitve, kakor je prikazano na sliki 2 (p1, p2, p3). V drugem primeru so bile porazdelitvene funkcije različne (p4 do 7), medtem ko je bila začetna vrednost d_{32} v vseh različicah enaka. Analiziranje karakteristik curka z uporabo iste velikostne porazdelitve p3 na šobah A, B in C je bilo izvedeno v primeru 3. V zadnjem primeru smo primerjali rezultate, dobljene v primeru šobe A s porazdelitvijo p3 in dejansko karakteristiko vbrizgavanja (K1-sl.2) uporabljeno v vseh poprejšnjih testiranjih s karakteristikama vbrizgavanja K2 in K3, prikazanima na sliki 2.

3 REZULTATI

Vrednosti d_{32} , izračunane z uporabo paketa FIRE za šobe A-1, A-2 in A-3, so prikazane na sliki 3. S slike je razvidno, da se vrednosti d_{32} v drugi polovici vbrizgavanja, kljub različnim začetnim vrednostim, ne razlikujejo bistveno. Do večjih razlik prihaja predvsem v začetnem delu vbrizgavanja. Te razlike lahko pripišemo razlikam v izbranih začetnih vrednostih d_{32} . Če med seboj primerjamo srednje vrednosti d_{32} v času vbrizgavanja,

In the first example we calculated the injection process and the spray formation for nozzle A using three different values of the initial Sauter mean diameter d_{32} and an equal probability curve (p1, p2 and p3-see Fig.2). The second example presents different distributions (p4 to p7, Fig.2) with an equal initial value of d_{32} for nozzle B. Three different nozzles (A, B and C) using the same initial droplet size distribution were employed in example 3. In the last example three different fuel-injection characteristics as shown in Fig. 2 were used.

3 RESULTS

The values of d_{32} calculated using the CFD package for nozzles A-1, A-2 and A-3 are presented in Fig. 3. It is evident that there are almost no differences between the d_{32} values in the second part of the injection, in spite of the different initial conditions. Major differences occur only during the early stage of the injection process. These differences are probably the result of different initial values of d_{32} . Comparing the calculated mean values of d_{32} in the chamber with the

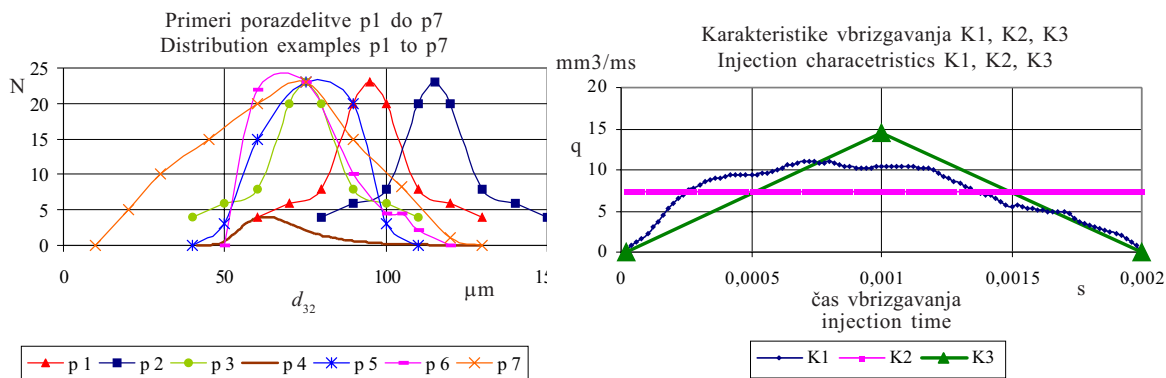

Sl. 2. Začetne porazdelitve in karakteristike vbrizgavanja
Fig. 2. Initial distributions and the fuel-injection characteristics

Preglednica 3. Tip šobe, porazdelitev in karakteristika vbrizgavanja za posamezen primer

Table 3. Type of the nozzle, distribution and the fuel-injection characteristics for a particular example

		Šoba Nozzle	Porazdelitev Distribution	Karakteristika Characteristics
Primer 1 Example 1	Šoba A-1 Nozzle A-1	A	p1	K1
	Šoba A-2 Nozzle A-2	A	p2	K1
	Šoba A-3 Nozzle A-3	A	p3	K1
Primer 2 Example 2	Šoba B-3 Nozzle B-3	B	p3	K1
	Šoba B-4 Nozzle B-4	B	p4	K1
	Šoba B-5 Nozzle B-5	B	p5	K1
	Šoba B-6 Nozzle B-6	B	p6	K1
	Šoba B-7 Nozzle B-7	B	p7	K1
Primer 3 Example 3	Šoba A-3 Nozzle A-3	A	p3	K1
	Šoba B-3 Nozzle B-3	B	p3	K1
	Šoba C-3 Nozzle C-3	C	p3	K1
Primer 4 Example 4	Šoba A-3/1 Nozzle A-3/1	A	p3	K1
	Šoba A-3/2 Nozzle A-3/2	A	p3	K2
	Šoba A-3/3 Nozzle A-3/3	A	p3	K3

ugotovimo, da so razlike v izračunanih vrednostih manjše od razlik med začetnimi srednjimi vrednostmi (pregl. 4).

S slike 3 je razvidno, da se povprečna vrednost d_{32} v komori v začetni fazi vbrizgavanja bistveno zmanjšuje, v času med 1/5 in 1/3 časa vbrizgavanja se povprečna vrednost d_{32} povečuje, v naslednji tretjini se ponovno zmanjšuje, v zadnji fazi pa se nekoliko poveča. Slednje povečanje lahko pripišemo dejstvu, da se najbolj oddaljene kapljice v tej fazi že približajo oziroma zadenejo ob steno komore,

imposed initial values, we can see that the differences between the calculated values are smaller than the differences between the initial values (Tab. 4).

From Fig. 3 we can see the decrease of the calculated mean value of d_{32} in the chamber during the first part of the injection. Between one-fifth and one-third of the injection time, the mean value of d_{32} increases, while in the next third it slightly decreases again. At the end of the injection process the mean value of d_{32} in the chamber decreases. This could be the result of droplet impingement into the chamber

kjer se dejansko nabirajo oz. združujejo, kar kljub upoštevanju uparjanja najverjetneje vodi do povečevanja d_{32} . Sam potek krivulj pa je predvidoma posledica karakteristike vbrizgavanja.

walls, where smaller droplets merge with the bigger ones. The shape of the curves presented in Fig. 3 is probably the result of the injection characteristics.

Preglednica 4. Primerjava začetnih in srednjih vrednosti d_{32} v komori za primer 1 z uporabo RDT
 Table 4. Comparison of the initial mean and calculated mean values of d_{32} in the chamber for example 1

	d_{32} začetni, sr v μm d_{32} initial, mean in μm	d_{32} izračunan, sr v μm d_{32} calc. mean in μm
Šoba A-1 Nozzle A-1	111,3	40,7
Šoba A-2 Nozzle A-2	127,5	44,9
Šoba A-3 Nozzle A-3	80,7	36,8

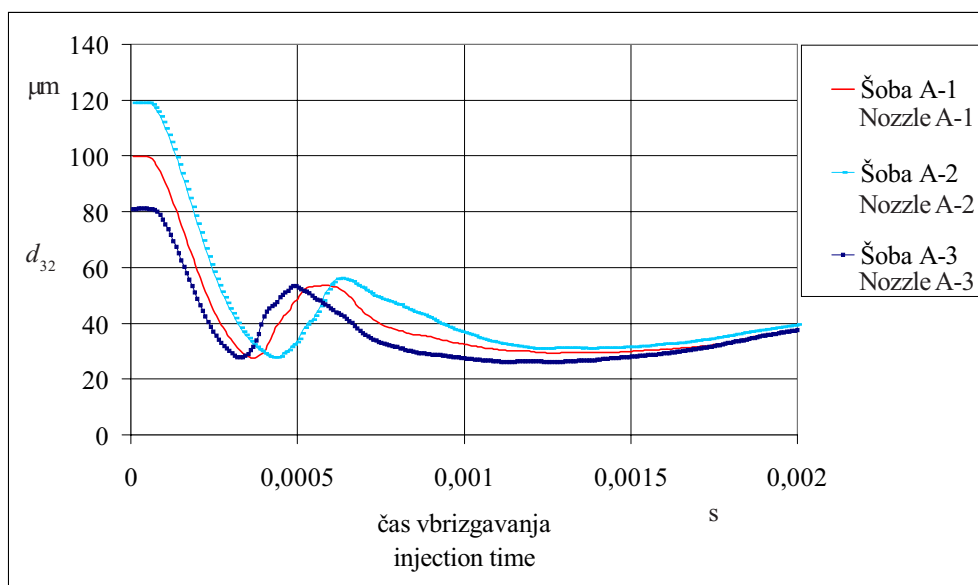

Sl. 3. Primerjava rezultatov analize z uporabo računske dinamike tekočin za primer 1
 Fig. 3. Comparison of the results from the CFD analysis for example 1

Preglednica 5. Primerjava srednjih vrednosti d_{32} za primer 1
 Table 5. Comparison of the calculated mean values of d_{32} for example 1

Model:	A-1	A-2	A-3	Hiroyasu	NACA	Lichty	Filipović	Hakki	Elkotb
d_{32} v μm d_{32} in μm	40,7	44,9	36,8	35,4	27,2	137,8	52,5	45,9	70,7

Če primerjamo rezultate, dobljene na temelju posameznega empiričnega izraza za različne porazdelitve, lahko ugotovimo, da se empirični rezultati med različnimi porazdelitvami (p_1, p_2, p_3) ne razlikujejo bistveno, ker verjetnostna porazdelitev ne vpliva bistveno na karakteristike curka, ki jih empirični izrazi uporabljajo za izračun vrednosti d_{32} (hitrost iztekanja, tlačni padec). Zato je bil v vseh različicah, kjer se pojavlja enaka šoba z enako karakteristiko vbrizgavanja in z različnimi porazdelitvami, upoštevan enak empirični rezultat. Iz rezultatov na sliki 4 je razvidno, da se d_{32} , dobljeni

If the results of one empirical model using different initial conditions are compared then only slight differences are observed because the initial droplet probability (p_1, p_2, p_3) does not have as much impact on the spray characteristics that are used in empirical calculations as the initial conditions (outflow velocity, pressure difference). According to this, in cases where only one nozzle and a single injection characteristic with a different initial probability are used, the same empirical results are employed. Fig. 4 shows major differences in the calculated values for d_{32} using different empirical models with the same initial conditions. The compari-

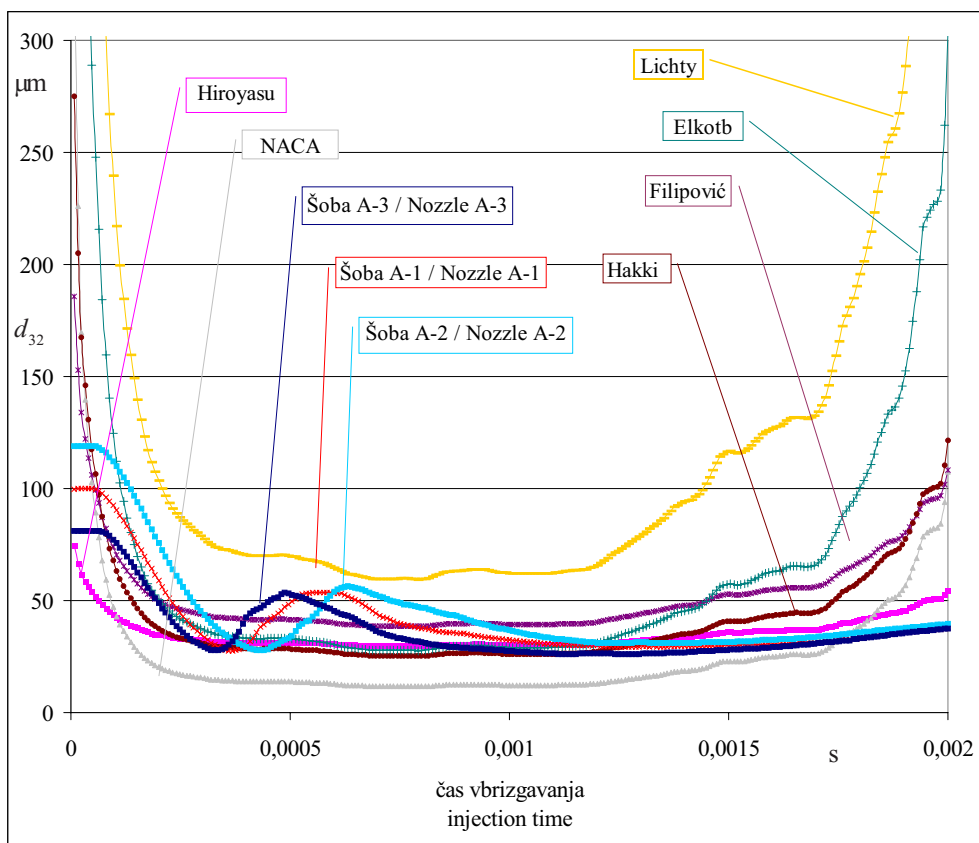

Sl. 4. Primerjava d_{32} izračunanih z računsko dinamiko tekočin in empiričnimi modeli
Fig. 4. Comparison of the results of d_{32} calculated using CFD and empirical models

po posameznih empiričnih izrazih, med seboj bistveno razlikujejo. Po primerjavi srednjih vrednosti (pregl. 4) d_{32} lahko ugotovimo, da empirična izraza Hakki in Hiroyasu za vse tri primere z odstopanjem, manjšim od 20 % dajeta razmeroma zelo natančne rezultate.

Iz rezultatov primera 2 na sliki 5 lahko ugotovimo, da na vrednost d_{32} v začetni fazi vbrizgavanja vpliva vrednost premera kapljice z največjo verjetnostjo, saj je d_{32} za šobo B-4 v začetni fazi bistveno manjši kakor v šobah B-3, B-5, B-6 in B-7. V nadaljevanju se poteki d_{32} razmeroma dobro prekrivajo. Iz tega lahko sklepamo, da velikostna porazdelitev v srednjem delu ne vpliva na d_{32} , medtem ko v končni fazi prihaja do večjih razlik med posameznimi šobami.

V preglednici 6 so prikazane srednje vrednosti d_{32} , od koder je razvidno, da Hakki in

son of the mean calculated values in the chamber is shown in Tab.5. The results of the CFD analysis are closest to the models of Hakki and Hiroyasu. The differences are smaller than 20 % in all three cases.

From the results of example 2, presented in Fig. 5, it is clear that the values of d_{32} during the early injection times are mainly influenced by the value of the initial droplet diameter with the highest probability. So the d_{32} at the nozzle B-4 is much smaller than the d_{32} in the other cases (B-3, B-5, B-6 and B-7). Later, the values of d_{32} in all cases are almost the same; so we can say that the value of the initial droplet diameter probability does not influence the value of d_{32} in chamber during the middle part of the injection. In contrast, the differences between the results for different nozzles during the second part of the injection are larger.

Table 6 presents the calculated mean values of d_{32} . Again, it is clear that the empirical models

Preglednica 6. Primerjava srednjih vrednost d_{32} za primer 2

Table 6. Comparison of the calculated mean values of d_{32} for example 1

Model:	Šoba B-3 Nozzle B-3	Šoba B-4 Nozzle B-4	Šoba B-5 Nozzle B-5	Šoba B-6 Nozzle B-6	Šoba B-7 Nozzle B-7
d_{32} v μm d_{32} in μm	26,2	31,6	31,7	27,3	28,9
Hiroyasu	NACA	Lichty	Filipović	Hakki	Elkotb
29,5	13,9	70,3	38,4	27,3	34,3

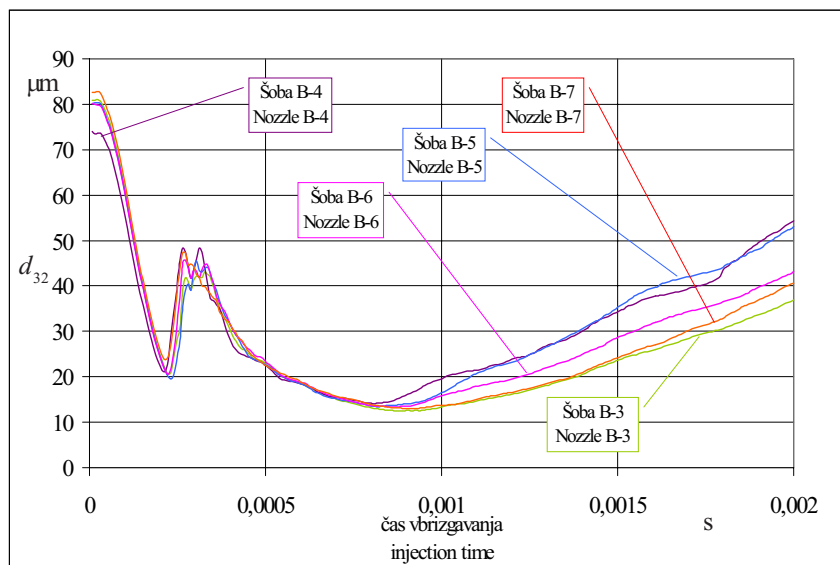

Sl. 5. Primerjava d_{32} za primer 2 z uporabo računske dinamike tekočin
Fig. 5. Comparison of d_{32} from the CFD analysis for example 2

Hiroyasu v vseh različicah ponovno najmanj odstopata.

Rezultati analize šob A, B in C so potrdili pričakovanja, da sprememba izmere odprtine šobe pomembno vpliva na vrednosti Sauterjevega premera kapljic v komori. Ne glede na enake začetne vrednosti d_{32} , se vrednosti d_{32} bistveno razlikujejo med seboj. Glede na to, da so bile za vse tri različice uporabljene iste porazdelitvene funkcije z enako začetno srednjo vrednostjo d_{32} , lahko ob analiziranju rezultatov v začetni fazi vbrizgavanja ponovno ugotovimo, da so izračunane vrednosti na začetku vbrizgavanja odvisne od premera kapljice z največjo verjetnostjo (sl. 6). V nadaljevanju so razlike večje, saj izmera odprtine šobe vpliva na hitrost iztekanja iz šobe, ki pomembno vpliva na potek razpada curka.

Najboljše prekrivanje empiričnih rezultatov z rezultati računalniške analize ponovno dajeta izraza Hiroyasu in Hakki. Oba se v celotnem času vbrizgavanja razmeroma dobro prekrivata z rezultati računske dinamike tekočin, ob tem pa so srednje vrednosti po času, izračunane po Hiroyasu, v obeh primerih manjše od 15% (pregl. 7).

S slike 7 je razvidno, da karakteristika vbrizgavanja bistveno vpliva na vrednosti d_{32} v komori. V začetni fazi vbrizgavanja prihaja do večjih odstopanj med vsemi karakteristikami, medtem ko se zadnji tretjini

of Hakki and Hiroyasu yield the smallest differences for all cases.

The results for the three different nozzles A, B and C confirmed our expectations that the nozzle-hole diameter significantly affects d_{32} in the chamber. In spite of the same initial droplet diameter and probability value, there are major differences in the d_{32} values in the chamber. Since the same initial droplet probabilities were used for all three nozzles, it is again clear that the calculated values of d_{32} at the beginning of the injection process are influenced by the initial droplet diameter with the highest probability (Fig.6). Later on, differences become larger, which is the result of the nozzle-hole outlet diameter, which significantly affects the outflow velocity and consequently the spray atomisation.

The smallest differences between the empirical and the CFD results are again found for the models of Hiroyasu and Hakki. During the whole injection period the results of both models are comparable with the CFD results. For the Hiroyasu model the mean value difference is smaller than 15% in all three cases (Tab. 7).

Fig. 7 shows that the injection characteristics have a great influence on the values of d_{32} in the chamber. The differences for all three cases are significant during the whole injection period. Only the

Preglednica 7. Primerjava izračunanih srednjih vrednosti d_{32} za primer 3
Table 7. Comparison of the calculated mean values d_{32} for example 3

		Fire	Hiroyasu	NACA	Lichty	Filipović	Hakki	Elkottb
d_{32} μm	Šoba A-3 Nozzle A-3	36,8	35,4	27,2	137,8	52,5	45,9	70,7
	Šoba B-3 Nozzle B-3	26,2	29,5	13,9	50,3	42,7	23,1	34,3
	Šoba C-3 Nozzle C-3	44,2	38,0	35,3	204,4	57,0	54,3	94,0

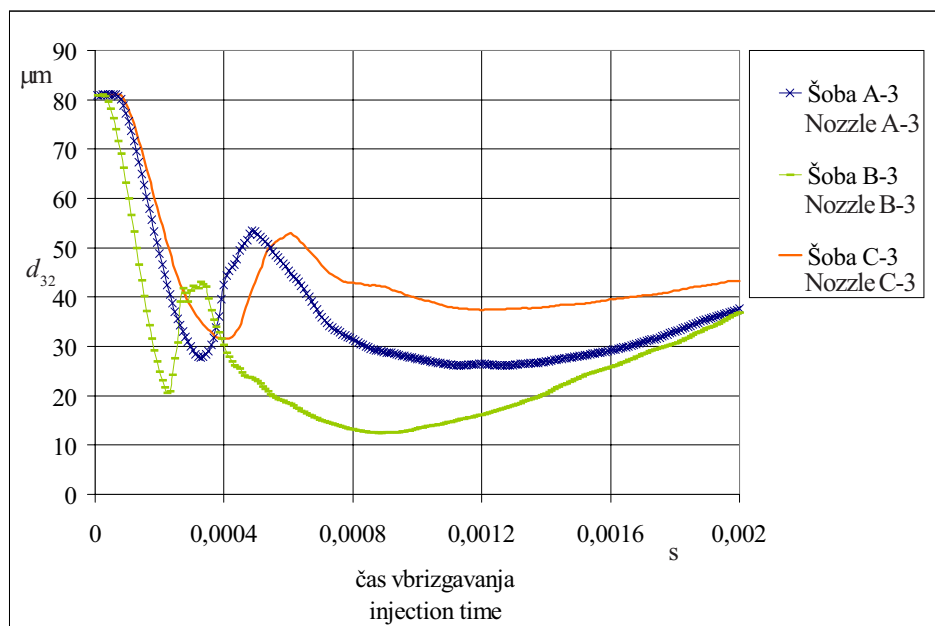

Sl. 6. Primerjava d_{32} za šobe A, B, C
Fig. 6. Comparison of d_{32} for nozzles A, B, C

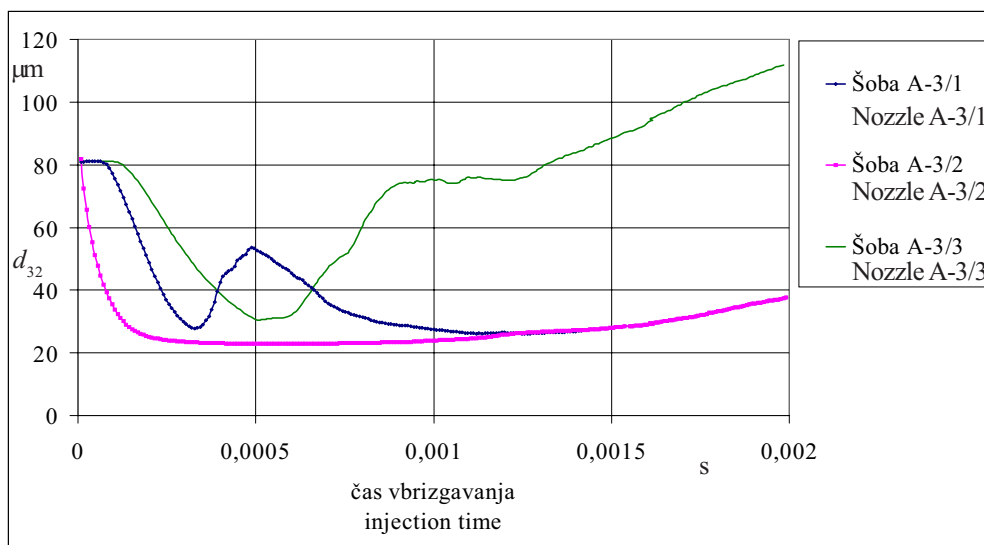

Sl. 7. Primerjava d_{32} za primer 4 z uporabo računske dinamike tekočin
Fig. 7. Comparison of the d_{32} results for example 4 using the CFD

vrednosti v primerih K1 in K2 karakteristike vbrizgavanja skoraj popolnoma ujemajo. Na drugi strani pa prihaja v primeru K3 do izredno velikih odstopanj. Ugotovimo lahko tudi, da je vrednost d_{32} na samem začetku vbrizgavanja enaka v vseh primerih. Iz tega lahko torej zagotovo sklepamo, da so vrednosti d_{32} v začetni fazi vbrizgavanja odvisne le od vrednosti premera kapljice z največjo verjetnostjo.

Primerjava z vrednostmi, izračunanimi z empiričnimi izrazi, ponovno pokaže, da izraz Hakki daje dobre rezultate, saj je odstopanje v vseh primerih ponovno manjše od 20 %, v primeru K3 je odstopanje celo manjše od 8 %.

results in cases K1 and K2, in the second part of the injection, are almost covered. Again, it is clear that the values of d_{32} in first few steps are almost equal in all three cases. From this we can conclude that the values of d_{32} at the beginning of the injection are mainly influenced by the value of the droplet with the highest probability.

A comparison of the CFD results with the empirical models again shows the smallest differences when using the empirical model of Hakki, where differences in all three cases are smaller than 20 %. In case K3 the difference is smaller than 8 %.

Preglednica 8. Primerjava srednjih vrednosti d_{32} za primer 4Table 8. Mean value of d_{32} comparison for example 4

	Model:	Fire	Hiroyasu	NACA	Lichty	Filipović	Hakki	Elkotb
d_{32}	K1	36,8	35,4	27,2	137,8	52,5	45,9	70,7
μ_m	K2	27,9	33,4	17,6	89,2	46,5	33,7	42,9
	K3	73,1	37,8	59,7	302,8	61,7	67,6	181,5

4 SKLEPI

Na temelju predstavljenih rezultatov lahko podamo naslednje sklepe:

Vrednost d_{32} na začetku vbrizgavanja je v glavnem odvisna od izbrane začetne srednje vrednosti kapljice z največjo verjetnostjo. S slik 3, 5, 6 in 7 je razvidno, da so vrednosti d_{32} na začetku vbrizgavanja enake začetnim vrednostim premera kapljic z največjo verjetnostjo.

Na vrednosti d_{32} v drugi polovici vbrizgavanja zraven geometrijske oblike šobe in karakteristike vbrizgavanja vpliva začetna velikostna porazdelitev kapljic.

Z uporabo empiričnih izrazov Hakki in Hiroyasu, ki v vseh analiziranih primerih dajeta podobne rezultate kakor računalniška analiza, si lahko pomagamo pri izbiranju začetnih vrednosti velikosti kapljic.

4 CONCLUSIONS

Based on our results we can make the following conclusions:

The d_{32} value at the beginning of the injection is mainly affected by the value of the initial droplet diameter with the highest probability. From Fig. 3, 5, 6 and 7 we can see that the values of d_{32} at the beginning of the injection are almost equal to value of the initial droplet with the maximum probability.

The value of the droplet d_{32} during the second part of the injection is mainly affected by the nozzle geometry, the injection characteristics and the initial droplet probability distribution.

Using the empirical models of Hakki and Hiroyasu, which always results comparable to the CFD analysis, the initial size of the droplets can be set.

5 LITERATURA

5 REFERENCES

- [1] FIRE Version 6.2b User manual, *AVL List GmbH Graz*.
- [2] Heywood, J.B., Internal combustion engine fundamentals, *McGraw-Hill, New York*, ISBN 0-07-028637-X.
- [3] Hiroyasu, H. et al. (1980) Fuel spray characterization in Diesel engines, Combustion modeling in reciprocating engines, 369-408, *Plenum Press*.
- [4] NACA Report 1300, Cleveland, Ohio, 1959.
- [5] Lichty, L. (1967) Combustion engine processes, *McGraw-Hill, New York*.
- [6] Hakki, O.Z., Calculation of spray penetration in Diesel engines, SAE 690254.
- [7] Filipović, I. (1983) Analiza motornih parametara ubrizgavanja alternativnih goriva, Doktorska disertacija, *Mašinski Fakultet Univerze u Sarajevu, Sarajevo*.
- [8] Elkotb, M.M. (1982) Fuel atomization for spray modeling, *J. Progress in Energy and Combustion Science*, Vol. 8, 1, 61-91.

Naslov avtorjev: mag. Martin Volmajer
doc.dr. Breda Kegl
Univerza v Mariboru
Fakulteta za strojništvo
Smetanova 17
2000 Maribor

Authors' Address: Mag. Martin Volmajer
Doc.Dr. Breda Kegl
University of Maribor
Faculty of Mechanical Eng.
Smetanova 17
2000 Maribor, Slovenia

Prejeto: 6.8.2001
Received:

Sprejeto: 7.12.2001
Accepted: