

Izdelava in optimizacija nove tehnologije varjenja pedala za avtomobilsko zavoro

Development and Optimisation of a New Technology for Welding the Brake Pedal of a Motor Vehicle

Janez Tušek - Miro Uran - Miran Jonke

V prispevku sta predstavljeni izdelava in optimizacija nove tehnologije varjenja pedala za avtomobilsko zavoro, ki temelji na elektroporovnem bradavičnem in točkovnem varjenju. Opisani so problemi do sedaj uporabljenega obločnega varjenja in razlogi za zamenjavo tehnologije. Za novo tehnologijo je bila izdelana vpenjalna priprava za hkratno vpetje telesa pedala, stopalke in naslona stikala. Optimizirani so bili parametri za bradavično varjenje stopalke na telo pedala, bradavično varjenje dela naslona na telo pedala in točkovno uporovno varjenje drugega dela naslona na telo pedala. Izveden je bil ekonomski izračun, ki je pokazal, da je bila zamenjava tehnologije ekonomsko potrebna, saj se z novo tehnologijo poenostavi proizvodnja zavornega pedala za osebni avtomobil.

© 2001 Strojniški vestnik. Vse pravice pridržane.

(Ključne besede: varjenje točkovno, varjenje bradavično, zavore avtomobilske, pedali, varjenje obločno)

We have developed and optimised a new technology for welding the brake pedal of a motor vehicle that is based on resistance-projection and spot-welding processes. We describe the problems encountered when using arc welding and the reasons for substituting the technology. To apply the new technology we constructed a fixture for the simultaneous clamping of a pedal body, a foot treadle and a stop-switch rest. We then optimised the parameters for the projection welding of the foot treadle to the pedal body and the stop-switch rest to the pedal body; we also optimised the resistance spot welding of the other part of the rest to the pedal body. Our costing of the process showed that the substitution of the technology was economically justified since the new technology simplified the manufacture of the motor-vehicle brake pedal.

© 2001 Journal of Mechanical Engineering. All rights reserved.

(Keywords: resistance spot welding, resistance projection welding, vehicle brakes, brake pedals, arc welding)

0 UVOD

Izdelava, uvajanje in optimizacija novih izdelovalnih tehnologij so najintenzivnejše in tudi najzahtevnejše prav v avtomobilski industriji. Med vsemi izdelovalnimi tehnologijami v celotni avtomobilski proizvodnji je varilska tehnologija prav gotovo tista, ki je najpomembnejša. Izboljšave njenih uporab in optimizacija potekajo v več smereh. Pomembni sta dve. Prva je uvajanje avtomatiziranih in robotiziranih trakov za izbran varilni postopek oziroma tehnologijo, ki sta integrirana v celotnem sistemu in vodena ter nadzirana iz enega mesta. Druga, prav tako zelo pomembna pa je optimalna izbira varilnega postopka in v okviru tega optimizacija samega varilnega procesa.

V našem primeru bomo prikazali zamenjavo obločne tehnike varjenja s tanko žico (varjenje MAG) zavornega pedala z elektroporovno tehniko brez dodatnega materiala. Predstavljena bo izdelava tehnologije za elektroporovno bradavično varjenje stopalke na telo zavornega pedala in uporovno

0 INTRODUCTION

Introducing, developing and then optimising new production technologies are some of the main challenges in the automotive industry. Among the production technologies used in the automotive industry, welding technology is certainly one of the most important. Its applications are spreading and its optimisation is proceeding in several directions. Two of these directions are important. The first direction is the introduction of automated and robotised lines for a selected welding process, which is then integrated into the system and controlled from a single location. The second direction is choosing the best welding process and then optimising it.

In our case we have substituted resistance welding without a filler material for arc welding with a thin wire, i.e. MAG welding. We will describe the development of the technology of projection welding the foot treadle to the brake-pedal body and re-

točkovna ter uporno bradavično varjenje naslona stikala prav tako na telo zavornega pedala.

Zavorni pedal oziroma pedalni sklop je z varnostnega vidika eden najpomembnejših delov vsakega motornega vozila. Glede na to morajo biti tudi izbrani materiali za pedal, tehnologija izdelave, vključno z varjenjem in nadzorom po varjenju, zelo kakovostni in izvedeni v skladu z najstrožjimi varnostnimi predpisi. To pomeni, da morajo biti zvari, ki bi s porušitvijo povzročili nevarnost za poškodbe potnikov v avtomobilu ali drugačno gmotno škodo, označeni kot varnostni zvari. Za te vare morajo biti varilni parametri med varjenjem nadzorovani, zapisovani pri vsakem varu in pri vsakem kosu ter po varjenju shranjeni še 15 let po izdelavi oziroma po prodaji avtomobila naročniku. Po varjenju mora biti na zvarih in zvarnih spojih izvedeno preverjanje kakovosti spoja po zahtevah veljavnih standardov ali pa po navodilih naročnika.

1 OPIS PROBLEMA

Že v uvodu smo zapisali, da je pedalni sklop iz varnostnih in upravljalških vidikov eden pomembnejših delov vsakega avtomobila. V pedalni sklop, ki je z notranje strani privit na sprednjo steno avtomobila, spadata pedal sklopke in zavorni pedal. Pedal za plin je poseben sklop, ki ne spada v pedalni sklop.

V tem prispevku bo predstavljena nova tehnologija zvarjanja stopalka in naslona stikala na telo zavornega pedala. Zavorni pedal je z vsemi deli in z dolžino obločno zvarjenih zvarov prikazan na sliki 1.

sistance spot welding and resistance projection welding of the stop-switch rest to the brake pedal.

In terms of safety, the brake pedal, i.e. the pedal assembly, is one of the most important elements in any motor vehicle. Consequently, the materials selected for the pedal and the production technology including the welding and control after welding should be of high quality and in accordance with the most stringent safety regulations. Furthermore, welds that could fail and produce serious injuries to car passengers or any other material damage should be marked as safety welds. The welding parameters of such welds should be controlled and registered, with each weld and workpiece stored for a period of 15 years after production, i.e. after the sale of the car. After welding, the welds and welded joints should be subjected to quality control in accordance with the relevant standards or the manufacturer's instructions.

1 THE PROBLEM TO BE ADDRESSED

The pedal assembly is one of the most important elements of every motor vehicle. It is mounted to the front car wall from the inside and consists of a clutch pedal and a brake pedal. The gas pedal is a separate assembly that is not part of the pedal assembly.

This paper describes a new technology for welding the foot treadle and the stop-switch rest to the brake body. The brake pedal with its elements and the arc welds are shown in Fig. 1.

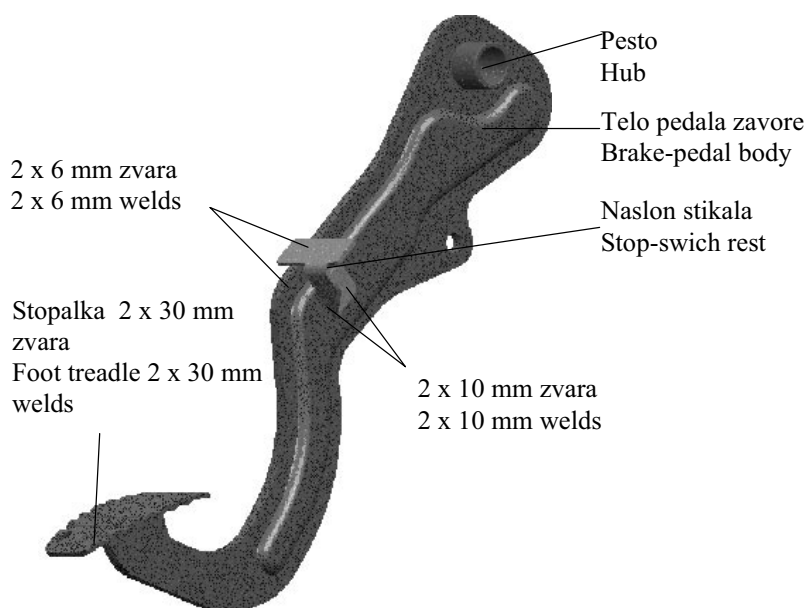

Sl. 1. Zavorni pedal sestavljajo telo pedala, stopalka, naslon stikala zavorne luči in pesto
Fig. 1. Brake pedal consisting of a pedal body, a foot treadle, a stop-switch rest, and a hub

Telo zavornega pedala je izdelano iz 6 mm debele jeklene pločevine. Na telo se po sedanji tehnologiji privarita po postopku MAG stopalka in naslon stikala. Kljub temu da je obločno varjenje robotizirano, je celoten postopek zamuden, negospodaren in kakovost zvara pogosto vprašljiva ali celo nezanesljiva.

Vse to so bili razlogi, da smo se odločili za zamenjavo sedanje tehnologije z novo, ki bo odpravila pomanjkljivosti obločnega varjenja s taljivo elektrodo.

2 OPIS SEDANJE TEHNOLOGIJE

Pri sedanji tehnologiji najprej z orodji za preoblikovanje (štancanje) in s stiskalnicami izdelamo telo pedala, stopalko in naslon stikala ter na obdelovalnem avtomatu pesto iz cevi (sl. 1). Nato v telo pedala vtisnemo pesto, za tem pa je na vrsti najpomembnejša operacija, to je varjenje naslona stikala stop in stopalke na telo pedala. Varjenje izvajamo na robotski celici, ki sestoji iz šestosnega členkastega robota Motoman K 10S, pozicionirne naprave, komandnega pulta, električne omare, vira varilnega toka Fronius Transarc 450, pnevmatskega čistilnika varilne pištole, zaščitne ograje in svetlobne zavese.

Varilne priprave za vpetje varjencev so pritrjene na dveh varilnih paletah (vsaka na eni strani mize H). Na vsaki paleti sta po dve gnezdi za varjenje naslona stikala zavorne luči in dve gnezdi za varjenje stopalke na telo pedala. Silo vpenjanja dobimo prek pnevmatskega sistema. Delavec najprej vloži v prvo gnezdo telo zavornega pedala in nato še naslon stikala. V drugo gnezdo pa vloži stopalko in nanjo namesti telo pedala z že zavarjenim naslonom. Pozicioniranje telesa pedala se izvede prek nakrčenega pesta. Nato delavec vklopi vpenjanje varjencev in pritisne gumb za obračanje mize. Po obračanju mize se prične robotsko varjenje. Ko robot konča varjenje, se pozicionirnik obrne, robot prične variti na drugi paleti, na prvi pa se varjenci avtomatično izpnejo, delavec vzame pedal z zvarjeno stopalko iz drugega gnezda in ga odloži v zaboj, tako se postopek ponavlja.

Iz povedanega lahko ponovno ugotovimo, da je celoten postopek izdelave zavornega pedala z obločnim varjenjem drag, da je v proces vključena draga oprema, da se med varjenjem porabljata [1] zaščitni plin in dodajni material, da so zaradi sevanja obloka in brizganja taline obremenjeni delavci in okolica. Odločilno vlogo pri odločitvi o zamenjavi tehnologije pa je imela kakovost zvarnih spojev. Zaradi razmeroma velikih toleranc izmer polizdelkov (telo pedala, stopalke, naslon stikala) je namreč lega vara zelo različna, ker zvarni stik med stopalko in telesom pedala ter naslonom in telesom zaradi odstopanja

The brake-pedal body is made of a 6-mm-thick steel plate. The current technology involves MAG welding the foot treadle and the stop-switch rest to the pedal body. Although the arc-welding process used is robotised, the whole procedure is time consuming and uneconomic, and the weld quality is often questionable or unreliable.

For these reasons we decided to substitute a new technology for the old one and, consequently, eliminate the weak points of arc welding by using a consumable electrode.

2 DESCRIPTION OF THE CURRENT TECHNOLOGY

With the current technology, first the pedal body, the foot treadle, and the stop-switch rest are made by forming, i.e. stamping and pressing, whereas the hub is made from a tube by automatic machining (Fig. 1). The hub is then inserted into the pedal body. Finally, the most important operation, i.e. welding of the stop-switch rest and the foot treadle to the pedal body, takes place. The weld is made in a robotic cell consisting of a Motoman K 10S six-axis articulated-arm robot, a positioner, a control panel, an electric cabinet, a Fronius Transarc 450 welding current supply, a pneumatic cleaning device for the welding gun, a protective fence, and a light curtain.

Welding jigs for the workpieces are mounted on two welding pallets, one at each side of an H table. At each pallet there are two clusters for welding the stop-switch rest and two for welding the foot treadle to the pedal body. The clamping force is supplied through a pneumatic system. A worker first places the brake-pedal body and then the stop-switch rest in the first cluster. In the second cluster, he then places the foot treadle and the pedal body with the rest already welded to it. The pedal-body positioning is accomplished with a shrink hub. Then the worker switches on the clamping of the workpieces and the table-turning. After the table is turned the robotic welding starts. When the robot stops welding, the positioner turns, and the robot starts welding at the other pallet. At the first pallet the workpieces are automatically removed. The worker takes the pedal with the foot-treadle welded to it from the second cluster and puts it to one side in a case. The whole procedure is then repeated.

The above description suggests that the manufacturing of the brake pedal by arc welding is quite expensive; it requires costly equipment as well as a shielding gas and a filler material that are consumed during welding [1]. In addition, the workers and the environment are at risk from arc radiation and molten-pool spatter. A key role in the technology substitution is played by the weld quality. Because of the comparatively high tolerances and the size of the semi-products, i.e. the pedal body, the foot treadle, and the stop-switch rest, the position of the weld varies considerably, which means that the weld

izmer ni vedno na natančno istem mestu. To pa je razlog, da je en varjenec slabo prevarjen drugi pa premočno ali nasprotno.

joint is not always found at the same location due to the inaccurate dimensions of the parts. This results in too strong or too poor penetration.

3 ELEKTROUPOROVNO VARJENJE ZAVORNEGA PEDALA

3 RESISTANCE WELDING OF THE BRAKE PEDAL

Pri iskanju rešitev za večjo produktivnost varjenja in doseganje boljše kakovosti zvarnih spojev smo proučili več različnih možnosti. Za povečanje produktivnosti smo raziskali uporabo več različnih obločnih zelo produktivnih postopkov, ki omogočajo varjenje z razmeroma velikimi hitrostmi.

Several alternatives were studied in order to achieve higher productivity and a better weld quality. To increase the productivity, several high-productivity arc-welding processes that permit comparatively high welding speeds were considered.

Slaba stran vseh teh postopkov je v velikem vnosu energije v varjenec in zato nastanek deformacij varjencev, stroški zaradi zaščitnega plina in dodatnega materiala ter slab izkoristek obločne energije in dodatnega materiala zaradi brizganja. Večjih hitrosti varjenja pa zaradi zapletenih oblik spojev in zahtevnih trajektorij robotskega varilnega gorilnika ni bilo mogoče uporabiti.

A disadvantage of these processes is the high energy input into the workpiece resulting in workpiece strains, increased costs due to gas and filler-material consumption and the low efficiency of the arc energy and the filler material due to spatter. Higher welding speeds, however, could not be used because of the complex joint shapes and the exacting trajectories of the welding torch of the robot.

Za doseganje boljše kakovosti zvarnega spoja smo raziskali možnosti za uporabo zaznaval za sledenje varilnega gorilnika po zvarnem stiku in ob morebitni napaki popravek njihovega obnašanja. Tudi za to izvedbo je poznana cela vrsta bolj ali manj natančnih naprav. Vsem pa je skupno to, da jim z zanesljivostjo delovanja cena močno naraste, pri čemer se pojavi vprašanje gospodarnosti.

With regard to weld quality, we looked at using sensors to track (and possibly correct) the welding blowpipe along the joint. A number of sensors with a range of accuracies are available, however, the necessary reliability comes at a high price, which reduces the cost-effectiveness.

Analiza rezultatov zgoraj omenjenih raziskav je pokazala, da je daleč najboljša rešitev zamenjava celotne tehnologije varjenja in uvedba elektrouporovnega namesto obločnega varjenja MAG (sl. 2).

An analysis of the results obtained in our studies indicates that the best solution is the substitution of the new technology for the old one and the introduction of resistance welding (Fig. 2).

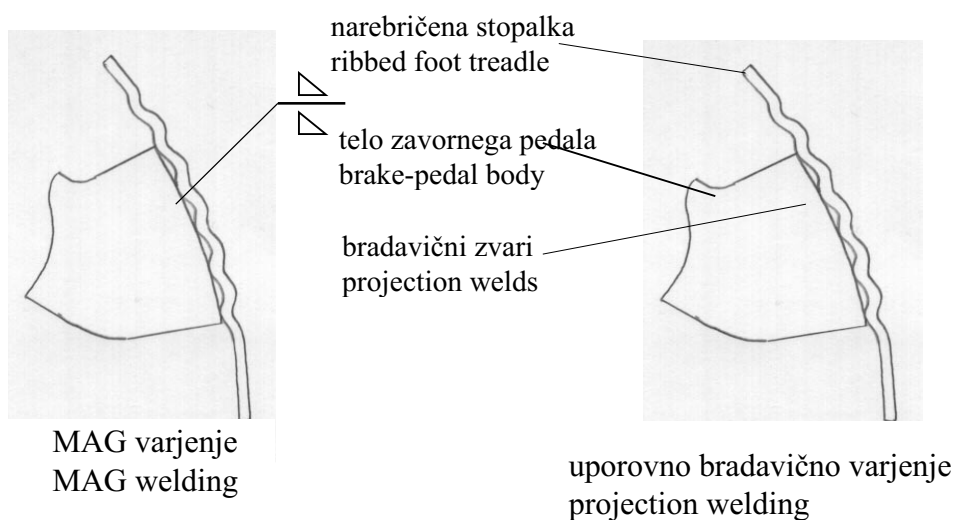

Sl. 2. Shematski prikaz zvarnega stika med stopalko in telesom zavornega pedala z oznakami za obločno (kotni zvar) in bradavično varjen spoj

Fig. 2. Schematic representation of a weld joint between the foot treadle and the brake-pedal body with markings for the arc (fillet) welded and projection welded joints

3.1 Elektroporno bradavično varjenje stopalke na telo zavornega pedala

Na sliki 2 sta shematsko prikazana način spajanja zavornega pedala in stopalke. Stopalka ni popolnoma ravna, ampak je valovito deformirana in na ta način mehansko ojačena oziroma se tako poveča njena togost. Prav valovitost stopalke v veliki meri onemogoča izdelavo kakovostnega kotnega zvara po talilnem obločnem postopku. Na desni strani iste slike lahko vidimo, da rebra na valoviti stopalki pomenijo bradavice, ki omogočajo uvedbo uporovnega bradavičnega varjenja brez dodatnih operacij in stroškov.

Uporovno bradavično varjenje je mogoče izvesti na stroju s posebno izdelano vpenjalno pripravo, ki je shematsko prikazana na sliki 3.

3.1 Resistance projection welding of the foot treadle to the brake-pedal body

Figure 2 schematically shows the joining of the brake-pedal body and the foot treadle. The foot treadle is wavy rather than completely flat, which makes it stiffer. And it is this waviness of the foot treadle that makes the production of a quality fillet weld by arc welding almost impossible. The right sketch in Figure 2 shows ribs in the wavy foot treadle which may be considered as projections permitting the introduction of projection welding without any additional operations and costs.

Resistance projection welding is possible with a machine having a special fixture as shown schematically in Fig. 3.

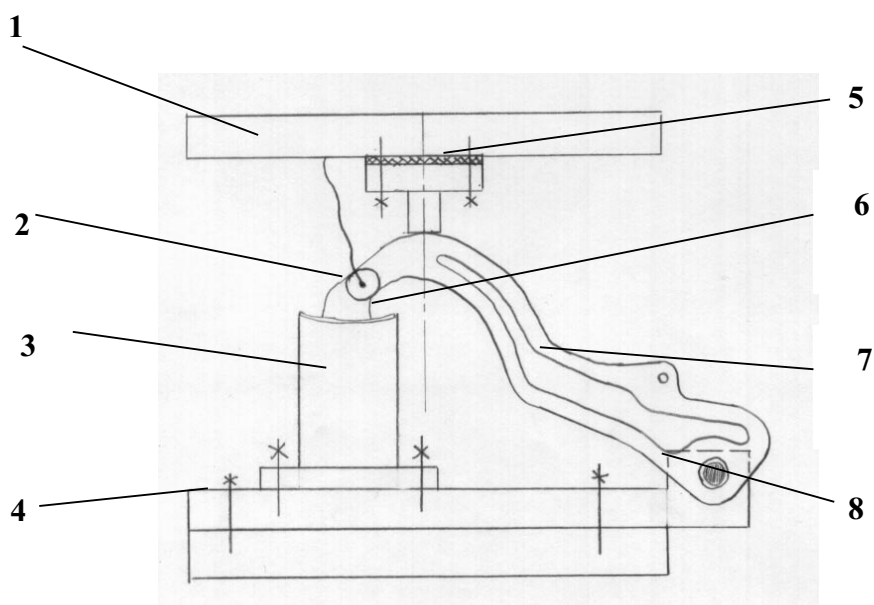

Sl. 3. Shematski prikaz priprave za uporno bradavično varjenje telesa zavornega pedala s stopalko
1 - zgornji del varilne priprave; 2 - zgornja elektroda za dovod toka; 3 - spodnja elektroda z ležiščem za stopalko; 4 - spodnji del varilne priprave; 5 - izolacija; 6 - stopalka; 7 - telo pedala; 8 - pozicioniranje in vpetje na pesto

Fig. 3. Schematic representation of a fixture for resistance projection welding of the brake-pedal body and the foot treadle

1 - upper part of the welding fixture; 2 - upper electrode for current supply; 3 - lower electrode with a bed for the foot treadle; 4 - lower part of the welding fixture; 5 - insulation; 6 - foot treadle; 7 - pedal body; 8 - positioning and fixing to the hub

Glede na velikost stičnih ploskev ali bradavic potrebujemo varilni stroj z minimalno močjo 300kVA ([2] in [3]). Ena večjih težav, ki se pri tem pojavi, je, kako po čim krajši poti s čim manjšo upornostjo dovesti zelo visoko jakost toka na telo pedala. Dovod toka na stopalko je dokaj preprost, saj ga izvedemo prek vpenjalne priprave in ležišča.

Na sliki 3 je shematsko prikazana optimalna rešitev za dovod toka na stranski ploskvi telesa pedala. Glede na to, da je površina oziroma prerez zvara 108 mm^2 , mora biti površina stika med

With regard to the size of the contact surfaces, i.e. projections, a welding machine with a minimum power of 300 kVA is required ([2] and [3]). One of major difficulties is how to supply a very high current to the pedal body, while keeping the distance and the resistance as small as possible. The current supply to the foot treadle is comparatively simple since it is accomplished through the fixture and the bed.

Figure 3 schematically shows the best solution for current supply to the side faces of the pedal body. As the cross-sectional area of the weld equals 108 mm^2 , the contact area between the workpieces

varjencema in elektrodami petkrat večja, to je 540 mm².

Drugi pomembnejši podatek je, da mora varilni stroj zagotoviti zadosti veliko silo stiskanja med varjencema in zadosti veliko hitrost stiskanja bradavic med varjenjem [1]. Pri premajhni hitrosti stiskanja se namreč lahko zgodi, da se bradavica segreje do tališča in da se pojavi brizganje taline zaradi prevelike gostote toka v bradavici ali zaradi prepočasnega stiskanja varjencev.

Telo pedala je pozicionirano vodoravno s pozicionirnim trnom za pesto. Stopalka prosto leži na ležišču spodnje elektrode. S tem je omogočeno razmeroma veliko odstopanje lege stika med telesom pedala in stopalko, kar pa še vedno zagotavlja izvedbo kakovostnega zvarnega spoja v dopustnih mejah odstopanja. Prav v tem, v možnosti manj natančnih toleranc polizdelkov, pa je ena večjih prednosti uporabe bradavičnega varjenja v primerjavi s talilnim obločnim varjenjem MAG. Poleg tega pa so tu še druge prednosti, ki smo jih že navedli v točki 2.

3.2 Elektroporovno točkovno varjenje naslona stikala zavorne luči

Naloga naslona stikala zavorne luči je, da vklaplja in izklaplja luč na zadnjem delu avtomobila, ki opozarja udeležence v prometu, da voznik avtomobila pred njim zavira.

Naslon stikala mora biti izdelan iz kakovostnega jekla in dobro privarjen na telo zavornega pedala ([4] in [5]). Na sliki 4 je shematsko prikazan naslon stikala. Kakor je razvidno s slik 1 in 4, je treba po "stari" tehnologiji izdelati dva 6 mm dolga zvara in dva 10 mm dolga zvara v različnih legah. Pri varjenju kratkih varov pomenijo velik strošek vmesni časi med varjenjem posameznih varkov, še posebej, če se varjenje izvaja z varilnim robotom.

and the electrodes should be five times that of the cross-sectional area, i.e. 540 mm².

It is also important that the welding machine should provide a sufficiently high contact force between the workpieces and a sufficiently high rate of projection pressing during welding [1]. If the rate of pressing is too low projection can heat up to the melting point and spatter occurs due to the current density being too high in the projection or due to the rate of pressing the workpieces together being too slow.

The pedal body is horizontally positioned by means of a hub mandrel. The foot treadle lies freely in the bed of the lower electrode. This permits a comparatively large mismatch between the pedal body and the foot treadle, but still ensures a good quality welded joint within the allowable limits. This possibility of using semi-products that have less accurate tolerances is one of the greatest advantages of projection welding in comparison to MAG welding. Other advantages were mentioned in section 3.

3.2 Resistance spot welding of the stop-switch rest

The purpose of the stop-switch rest is to switch the light at the rear of the car on and off to warn other road users that a driver is applying the brake.

The stop-switch rest should be made of a high-quality steel and correctly welded to the brake-pedal body ([4] and [5]), see Fig. 4. From Figures 1 and 4 we can see that the old technology requires two welds that are 6 mm long and two welds that are 10 mm long in different positions. For the shorter welds the cost is increased because of the intervals between the welding of the individual weld beads, particularly if the welding is robotised.

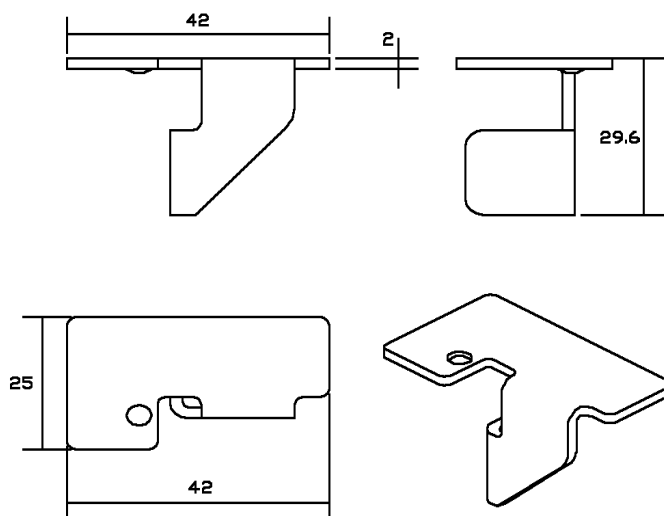

Sl. 4. Shematski prikaz naslonjala stikala zavorne luči z eno bradavico
Fig. 4. Schematic representation of the stop-switch rest with a single projection

Z novo tehnologijo bomo naslon stikala privarili na telo pedala z dvema zvarnima točkama. Eno bomo zvarili uporovno bradavično z vnaprej izdelano bradavico in eno točkovno uporovno s primerno oblikovanima elektrodama. Obeh zvarnih spojev ni mogoče izdelati bradavično, čeprav bi bilo to iz več vidikov zelo ugodno.

Izdelava bradavic v celotnem izdelovalnem postopku ne pomeni praktično nobenega stroška. Prednosti bradavičnega varjenja v primerjavi z uporovnim točkovnim pa je splošno znana in je večkratna (lažje pozicioniranje, manjša obraba elektrod, lepši videz vara, vnaprej določeno mesto vara, ni brušenja elektrod).

Po izbiri tehnologije varjenja naslona na telo pedala je treba izdelati vpenjalno pripravo, ki bi omogočila vpetje obeh varjencev in bradavično ter točkovno zvarjanje. Na sliki 5 je shematsko prikazana naprava, ki omogoča izvedbo zgoraj opisane tehnologije.

3.3 Hkratno varjenje stopalke in naslona stikala zavorne luči na telo pedala

S celovito analizo vseh treh uporovno zvarjenih spojev stopalke in naslona stikala na telo zavornega pedala ter s študijem obeh priprav za vpetje varjencev smo prišli do sklepov, da je mogoče privariti oba elementa na zavorni pedal pri enem samem vpetju v eno samo vpenjalno napravo na enem stroju s tremi ločenimi viri toka za tri vare.

Na sliki 6 je prikazana varilna naprava s sklopom za pozicioniranje in vpetje pedala na nakrčeno pesto. Slika prikazuje tudi osnovno ploščo

The new technology requires only two spot welds between the stop-switch rest and the pedal body. One spot weld will be made by projection welding with a projection provided in advance and the other one by spot welding using suitably shaped electrodes. It is not possible to make both welded joints by projection welding although this would be very favourable from several viewpoints.

Making the projections costs almost nothing in terms of the entire production process. The advantages of projection welding are multiple and well known, i.e. positioning is easier to accomplish, the electrodes are subjected to less wear, the weld has a nicer appearance, the weld position is determined in advance, and there is no grinding of the electrodes required.

After the technology for welding the stop-switch rest to the pedal body was selected, it was necessary to construct a fixture for the two workpieces and the projection as well as the spot welding. Figure 5 schematically shows such a fixture.

3.3 Simultaneous welding of the foot treadle and the stop-switch rest to the pedal body

A thorough analysis of the three resistance welded joints of the foot treadle and the stop-switch rest to the pedal body shows that it is possible to weld the two components to the brake-pedal body by fixing them only once in a single fixture at a single machine using three separate current sources for the three welds.

Figure 6 shows the welding device with the assembly for positioning and fixing of the pedal to the shrink hub. It also shows the base plate with the

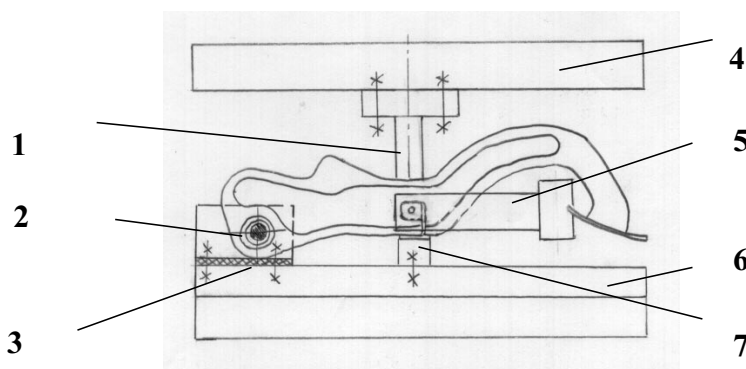

Sl. 5. Shematski prikaz vpenjalne priprave za vpetje telesa pedala in naslona stikala zavorne luči ter lega obeh parov elektrod za bradavično in točkovno varjenje
1 - zgornja elektroda za bradavično varjenje naslona; 2 - pozicioniranje in vpetje pedala; 3 - izolacija; 4 - zgornji del priprave; 5 - varilne klešče za točkovno varjenje naslona; 6 - spodnji del priprave; 7 - spodnja elektroda za bradavično varjenje naslona

Fig. 5. Schematic representation of the fixture for fixing the pedal body and the stop-switch rest and position of both pairs of electrodes, that is for projection and spot welding
1 - upper electrode for projection welding of the rest; 2 - positioning and fixing of the pedal; 3 - insulation; 4 - upper part of the fixture; 5 - welding pliers for spot welding of the rest; 6 - lower part of the fixture; 7 - lower electrode for projection welding of the rest

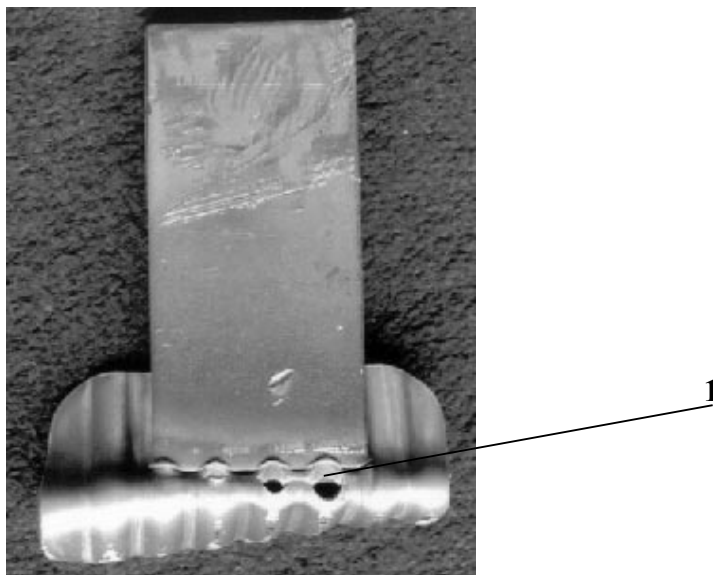

Sl. 7. Porušitev bradavično zvarjenega spoja stopalke in telesa zavornega pedala
1 - porušitev v osnovnem materialu

Fig. 7. Failure of projection welded joint between the foot treadle and the brake-pedal body
1 - failure in parent metal

med 9 in 11 periodami omrežnega toka ter optimalna sila stiskanja varjencev 19 kN.

Na sliki 7 je prikazan posnetek porušitve spoja med stopalko in telesom pedala. Že iz samega načina porušitve lahko vidimo, da je trdnost spoja dobra, saj je do porušitve prišlo zunaj spoja v osnovnem materialu, in da je pred porušitvijo prišlo do močne deformacije stopalke.

Za natančno ugotovitev velikosti prevaritve bradavic in toplotno vplivane cone okoli njih smo napravili makro obruse. Shematski prikaz makro obrusa je prikazan na sliki 8.

4.2 Bradavično in točkovno zvarjeni naslon stikala zavorne luči na telo pedala

Podobno kakor zgoraj smo tudi tu z eksperimentalnimi rezultati ugotovili optimalne varilne parametre. Za bradavično zvarjanje znašajo: $I = 5$ do 8

the optimum welding time (t) between 9 and 11 periods of the mains current, and the optimum force of pressing (F) was 19 kN.

Figure 7 shows a failure of the welded joint between the foot treadle and the pedal body. The mode of failure indicates that the strength of the joint was good since the failure occurred outside the joint, i.e. in the parent metal, and that prior to the failure, a strong deformation of the foot treadle occurred.

In order to establish the penetration size of the projections and the heat-affected zone next to them we made macro specimens. An example is shown in Fig. 8.

4.2 Stop-switch rest projection and spot welded to the pedal body

As with the previous example we again looked for the optimum welding parameters. For projection welding the optimum parameters were: $I = 5$ to

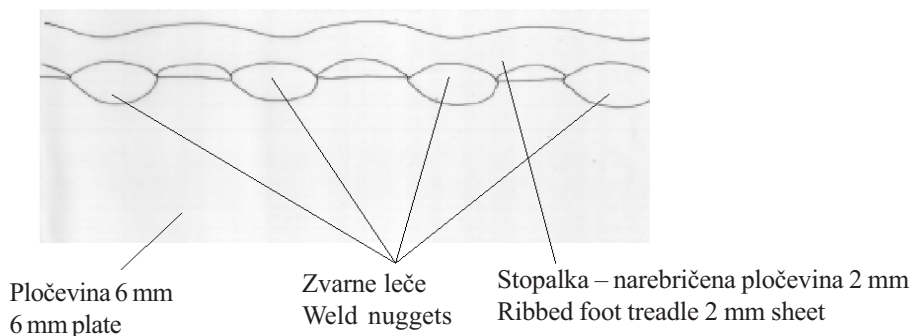

Sl. 8. Shematski prikaz makro obrusa bradavično zvarjenega spoja stopalke in telesa zavornega pedala
($I = 24,9$ kA, $t = 11$ P = 0,22 s, $F = 19,0$ kN)

Fig. 8. Schematic representation of a macro specimen of the projection welded joint between the foot treadle and the brake-pedal body ($I = 24.9$ kA, $t = 11$ P = 0.22 s, $F = 19.0$ kN)

kA, $t = 6$ do 9 P, $F = 5$ kN. Optimalni vrednosti smo dobili s trdnostno analizo spoja po varjenju in z oceno poteka varjenja (brizganje). Za točkovno varjenje naslona pa optimalni parametri znašajo: $I = 6,5$ do 8 kA, $t = 17$ do 19 P in $F = 5$ kN.

Shematsko prikazan makro obrus točkovno uporovno zvarjenega spoja naslona na telo pedala pa lahko vidimo na sliki 9. S slike so razvidni velikost zvarne leče, velikost toplotno vplivane cone in vtis v naslonu zaradi pritiska elektrode med varjenjem. Na debelejši pločevini, na telesu pedala, pa vtiska ne opazimo, ker je premer elektrode večji in je s tem specifični pritisk na pločevini manjši, kar vodi do manj prizadete in manjše toplotno vplivane cone.

8 kA, $t = 6$ to 9 P, $F = 5$ kN. The optimum values were obtained by analysing the joint strength after welding and by assessing the welding process (spatter). With spot welding, the optimum parameters were: $I = 6.5$ to 8 kA, $t = 17$ to 19 P, and $F = 5$ kN.

A macro specimen of the spot-welded joint between the stop-switch rest and the pedal body is schematically shown in Fig. 9. The figure shows the sizes of the weld nugget and the heat-affected zone as well as an indentation in the rest due to electrode pressure during welding. With the thicker plate, i.e. at the pedal body, no indentation is observable because the electrode diameter is larger and the specific pressure on the plate is smaller, which produces a smaller and less heat-affected zone.

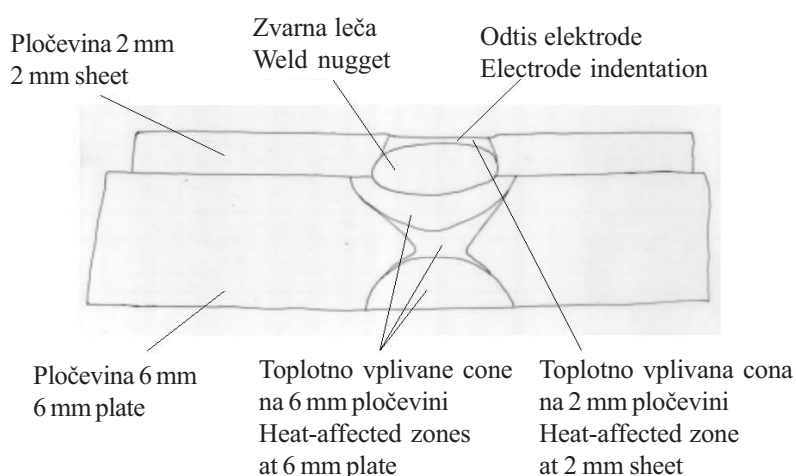

Sl. 9. Shematski prikaz makro obrusa točkovno zvarjenega spoja med naslonom in telesom pedala
 Fig. 9. Schematic representation of a macro specimen of the spot welded joint between the rest and the pedal body

5 EKONOMSKA UPRAVIČENOST ZAMENJAVE TEHNOLOGIJE

Z doslej napisanimi dejstvi v tem prispevku smo pokazali, da je zamenjava varilskih tehnologij s tehnološkega vidika mogoča in primerna. S preprostim ekonomskim izračunom želimo pokazati, da je bila zamenjava tudi potrebna in ekonomsko upravičena.

Pri izračunu stroškov obločnega varjenja smo izračunali čase robotskega varjenja stopalke in dvakrat dveh zvarov naslona stikala. Pri tem smo poleg čistih časov varjenja upoštevali tudi druge čase: to so časi obračanja, vrtenja mize, prehodov robota, čiščenja gorilnika in časi, potrebni za pripravo varjenja.

V izračunu stroškov porabljene električne energije smo upoštevali energijo za varjenje vseh varov, obračanje in pogon robota ter pogon vpenjalne mize z gnezdi. Izračunali smo stroške za porabljen zaščitni plin in varilno žico kot dodatni material in vse stroške dela, delovne sile in opreme. V stroške dela smo všteli ceno strojne ure, amortizacijo stroja, stroške prostora, vzdrževanja, potrošni material, stroške delovne sile z dejanskimi in pripravljalnimi

5 ECONOMIC JUSTIFICATION OF THE TECHNOLOGY SUBSTITUTION

We have shown that the substitution of the welding technology is feasible and reasonable from the viewpoint of technology. A simple economic calculation should also show that the substitution was necessary and economically justified.

When costing the arc welding we took into account the times required for robotic welding of the foot treadle and the two times for the two welds of the stop-switch rest. In addition to the welding times, we also considered the times for table rotation, the robot passages, the gun cleaning and the preparation for welding.

The costs of electricity included the energy required for all the welds, turning and operating the robot and operating the fixing table with the clusters. The costs of the shielding gas and the wire filler material were calculated too. We also included into the calculations all the costs relating to workforce and machines. A similar calculation of the costs

terrežjskimi časi. Podobno smo ravnali pri izračunu stroškov pri uporabi nove varilske tehnologije. Tudi tu smo najprej izračunali čase varjenja vseh treh zvarnih spojev, nato stroške energije, stroške delovne sile, stroške stroja (amortizacija) ter stroške porabljenih elektrod.

Povzetek vseh stroškov in časov za obe tehnologiji je podan v preglednici 1.

Z izračuni smo ugotovili, da so stroški izdelave enega kosa z obločnim varjenjem 67,79 SIT in po uporovnem le 29,10 SIT, kar pomeni, da je z novo tehnologijo pri vsakem zvarjenem pedalu prihranek 38,69 SIT.

S preprostim izračunom lahko ugotovimo, da bo investicija, če ta stane 12 mio SIT in če je letni obseg proizvodnje 220.000 kosov, povrnjena v osemnajstih mesecih.

Preglednica 1. Primerjalna razpredelnica porabljenega časa, energije, pomožnega materiala, stroškov delovne sile in stroškov proizvodnih sredstev

Table 1. A comparative table of the time, energy, auxiliary material consumed and of the costs of workforce and production means

	Obločno varjenje Arc welding	Uporovno varjenje Resistance welding
Čas varjenja / kos (min) Welding time/piece (min)	0,636	0,350
Strošek energije / kos (SIT) Cost of energy/piece (SIT)	1,262	0,210
Zaščitni plin / kos (SIT) Shielding gas/piece (SIT)	3,441	/
Žica / kos (SIT) Welding wire/piece (SIT)	1,38	/
Delavec / ura (SIT) Man-hour (SIT)	3070	2800
Stroj / ura (SIT) Machine hour (SIT)	2445	1900
Strošek elektrod / kos (SIT) Cost of electrodes/piece (SIT)		1592

6 MNENJE

Za pravilno in verodostojno oceno kakovosti ter zahtevnosti opisanih raziskav in dobljenih rezultatov je treba dodati, da predstavljeni postopki, ki temeljijo na elektroporovnem varjenju, niso standardne strojniške ali mehansko-preoblikovalne operacije, pri katerih sta potrebna orodje in mehanska sila, ampak so zapleteni metalurško-mehanski in elektromagnetno-fizikalni pojavi, ki jih je bilo treba med raziskavo upoštevati. V prvi vrsti je izmenično magnetno polje, ki ga povzroči izmenični varilni tok z jakostjo več deset tisoč amperov. Prav razmerje med ohmsko in induktivno upornostjo, ki je odvisno od številnih dejavnikov, lahko odigra pomembno vlogo. Velik

6 OPINION

In order to assess the investigations made and the results obtained, it must be pointed out that the processes involved in resistance welding are not the conventional operations of mechanical engineering or mechanical forming using just tools and a mechanical force but very intricate metallurgical-mechanical and electromagnetic-physical processes. First we have an alternating magnetic field generated by an alternating current of more than several times 10000 A. The relationship between the ohmic and inductive resistances, which depends on a number of factors, can play a very important role. An impor-

vpliv na to imajo oblika, velikost in vrsta materiala, ki je v "oknu" med dvema elektrodama. Pri velikem »oknu« med obema elektrodama, ali če so v oknu varjenec, del kovinske priprave ali drugi elementi, se jakost toka lahko »porazgubi« in se spremeni v jalovo energijo. Vse te dejavnike je bilo treba pri raziskovalnem, teoretičnem in eksperimentalnem delu upoštevati. To nam je po napornem delu tudi uspelo.

Drugi problem pa so toplotne napetosti, ki se pojavijo v varjencu med varjenjem in po njem. Tudi tega smo s pravilno oblikovano vpenjalno napravo in s pravilnim vrstnim redom varjenja uspešno rešili.

7 SKLEP

Z izdelavo nove tehnologije zvarjanja zavornega pedala za osebni avtomobil in z zamenjavo s staro obločno tehniko smo povečali produktivnost, izboljšali kakovost zvarov, zmanjšali izmet, izboljšali delovne razmere zaposlenih, zmanjšali potrebe po nabavi materiala (varilna žica, zaščitni plin).

Najboljši sklep na koncu študije poda ugotovitev, da z novo tehnologijo varjenja pri vsakem pedalnem sklopu prihranimo 38,69 SIT in da bodo pri sedanjem obsegu proizvodnje investicijska sredstva povrnjena v enem letu in pol.

tant influence is exerted by the shape, the size and the type of material in the space between the two electrodes. If this space is large or the workpiece, a part of the metal device or other elements are located in this space, current may get "lost" and transform into waste energy. All these factors had to be considered in the theoretical and experimental investigation. Eventually this was done successfully.

Another problem are the thermal stresses occurring in the workpiece during and after welding. The problem was successfully solved by a correctly shaped fixture and a correct welding sequence.

7 CONCLUSION

The substitution of the new technology of welding the brake pedal for a motor vehicle for the arc welding technology resulted in increased productivity, an improved weld quality, less scrap, improved working conditions for workers, lower consumption of the welding wire and the shielding gas.

The most encouraging conclusion is that the new welding technology permits a saving of 38.69 SIT for each pedal assembly and the investment in the equipment can be paid off in a year and a half.

8 LITERATURA 8 REFERENCES

- [1] Rihar, G. (1988) Gradivo za seminar "Evropski inženir varilstva"; Ljubljana.
- [2] Kralj, V., Z. Kodrič, A. Kôvesh (1991) Točkovno uporovno varjenje; *Institut za varilstvo*; Ljubljana, 34-36.
- [3] Kordič (1987) Elektrootporno zavarivanje. *Društvo za tehniku zavarivanja Hrvatske*; Zagreb, 56-61.
- [4] PSA (1999) But de la procedure; Support pedale debrayage et de frein.
- [5] PSA (2000) Norma R 17 1103 - Mehanski sklopi za upravljanje vozila: Pedalni sklop, Nosilec pedalov kpl. iz pločevine.

Naslova avtorjev: prof.dr. Janez Tušek
Miro Uran
Institut za varilstvo,d.o.o.
Ptujška 19
1000 Ljubljana

Miran Jonke
Cimos commerce, d.o.o.
Cesta Marežanskega upora 2
6000 Koper

Authors' Addresses: Prof.Dr. Janez Tušek
Miro Uran
Institute of welding Ltd.
Ptujška 19
1000 Ljubljana, Slovenia

Miran Jonke
Cimos Commerce, d.o.o.
Cesta Marežanskega upora 2
6000 Koper, Slovenia

Prejeto: 28.8.2001
Received:

Sprejeto: 7.12.2001
Accepted: