

# Kombinirano daljinsko ogrevanje in hlajenje v mestu Gera (Nemčija) s tehnologijo parnih kotlov

## A Combined District Heating and Cooling Network in City of Gera (Germany) using Steam-Jet Ejector Technology

Peter Noeres - Daniel Hölder - Wilhelm Althaus

*Prispevek predstavlja tehnologijo parnega ejektorja in njegovo uporabo v primeru pilotnega projekta oskrbe z energijo Gera v Nemčiji (ustanovitelj Nemško ministrstvo za znanost in izobraževanje). S tem projektom je bila izdelana hladilna naprava s parno ejektorsko hladilno enoto in kompresorskim hladilnikom, ki oskrbuje daljinsko hlajenje v središču mesta Gera. V prispevku bo prikazan tehnični koncept hladilnega obrata, karakteristike parnega ejektorja, prejšnje izkušnje iz obratovanja in področja uporabe v prihodnosti. © 2000 Strojniški vestnik. Vse pravice pridržane.*

**(Ključne besede: ogrevanje daljinsko, hlajenje daljinsko, ejektorji parni, stroški obratovalni)**

*The paper introduces steam-jet ejector technology and its use in a pilot project of Energieversorgung Gera GmbH in Germany (funded by the German Ministry of Science and Education). Within this project a chiller plant with a steam-jet ejector chiller unit and a compression chiller supplies a district cooling network in downtown Gera, Germany. The technical concept of the chiller plant, performance characteristics of the steam-jet ejector, previous operational experiences and future areas of application will be described. © 2000 Journal of Mechanical Engineering. All rights reserved.*

**(Keywords: district heating, district cooling, steam ejectors, operating costs)**

### 0 UVOD

Kot del integralne energijske oskrbe toplotno vodeni hladilniki vode nudijo veliko prednosti v primeru kombinirane proizvodnje toplote, hladu in moči (KPTHM - CHCP) v povezavi z daljinskim ogrevanjem ali kombinirano proizvodnjo toplote in elektrike. Izboljšana uporaba in s tem tudi gospodarnko obratovanje je mogoče s toplotno gnanimi hladilniki še posebej v poletnih mesecih. V nasprotju z električno gnanimi kompresorji hladilnikov je v primeru kombinirane proizvodnje elektrike in toplote (KPET - CHP) mogoče zmanjšanje uporabe primarne energije. Nadalje je mogoče izbrati naravna hladiva kot sta voda in amoniak, od katerih nobeden ne prispeva k učinku tople grede. Visoki investicijski stroški hladilnih obratov s toplotno gnanimi hladilnimi procesi in njihove karakteristike so glavni problem KPTHM v Nemčiji. Začetek obratovanja hladilnega obrata je bil v letu 1997. Dobava hladu je bila začeta januarja leta 1998.

### 0 INTRODUCTION

As part of an integrated energy supply thermally driven chilled water generation offers many advantages within the context of a combined heat, cold and power supply (CHCP) in connection with district heating or block heat and power plants. An improved utilisation, and thus economical operation of CHP plants becomes possible with thermally driven chillers, particularly in the summer months. In contrast to chilled-water generation with electrically driven compression chillers, a reduction of primary energy demand can be realised by the use of heat from CHP plants. Furthermore, natural refrigerants such as water or ammonia can be chosen, none of them contributing to the greenhouse effect. However, the high investment costs for chiller plants with thermally driven refrigeration processes and their performance characteristics are a problem regarding the realisation of CHCP in Germany. The operation of the chiller plant started in early 1997. The cold supply started in January 1998.

## 1 NASTAJANJE HLADU S SISTEMOM PARNEGA EJEKTORSKEGA HLAJENJA

Manj znani hladilni proces je parni ejektorjski hladilnik. Njegova uporaba v kemijskih procesih kot hladilna naprava ali vakuumska črpalka je že dolgo poznana. Do sedaj je njego uporaba v kombinaciji s KPTHM realizirana le v primeru dveh demonstracijskih projektov na Danskem in v Nemčiji. V tej tehnologiji je mehanski kompresor nadomeščen s parnim ejektorjem (sl.1).

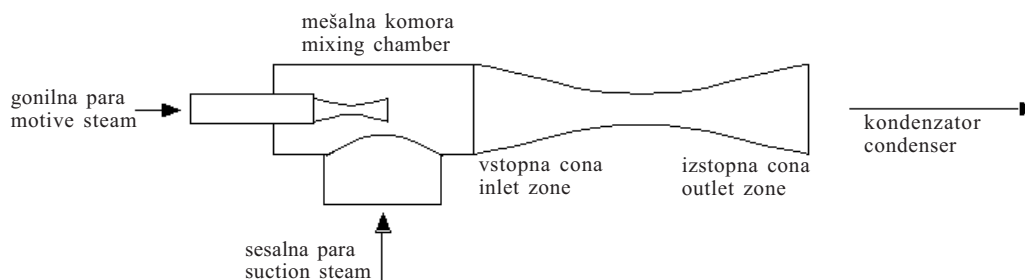

Sl. 1. Model parnega ejektorja  
Fig. 1. Model of a steam-jet ejector

Proces je sestavljen iz dveh krogov, srednjega gonilnega kroga in hladilnega kroga. Tlačna energija iz gonilnega kroga se spremeni v kinetično energijo v gonilni šobi parnega ejektorja. Para hladiva je vodena vanj iz uparjalniške mešalne komore. Tlak pare v uparjalniku se znižuje, dokler se hladivo uparja in hladna voda se hladi glede na potrebno hladilno moč. S to tehnologijo se lahko dosežejo tudi temperature pod 0 °C.

V difuzorju se gibalna energija gonilne pare in hladilne pare spremeni nazaj v tlačno energijo. Celotni masni tok je stisnjen na tlačni nivo glede na tlak uparjanja vode pri hladilnih temperaturah. Para kondenzira v pršilnem kondenzatorju. Toplota kondenzacije se odvaja v hladilnem ciklusu z uporabo ploščnega prenosnika toplote, kondenzat pa vodi nazaj v uparjalnik ali v zbiralnik daljinskega ogrevalnega sistema.

Ker je hladivo voda, lahko proces razdelimo v parni, hladno vodni in hladilno vodni sistem. Pršilni kondenzator in uparjalnik (odprt ali pol odprt proces) se lahko uporabita namesto prenosnikov toplote. Zaprt proces lahko uporabljamo tam, kjer je delitev narejena s prenosniki toplote.

Karakteristike delovanja parnega ejektorjskega hladilnega sistema so drugačne od drugih toplotnih hladilnih sistemov. Hladilno število (HŠ - COP) je močno odvisno od tlaka kondenzatorja in s tem od temperature hladilne vode. To definira temperatura zraka in delovanje hladilnih stolpov. Poleti pri veliki vlagi v zraku in visokih zunanjih temperaturah

## 1 COLD GENERATION WITH STEAM-JET REFRIGERATING SYSTEMS

The steam-jet ejector chiller (SJEC) is a little-known refrigeration process. Its use in the area of chemical processes as a cooling device or vacuum pump has long been known. Until now, its use in combination with CHCP, however, has only been realised within the context of two demonstration projects in Denmark and Germany. In SJEC technology the mechanical compressor of a compression chiller is replaced by a steam-jet ejector (see figure 1).

The process consists of two cycles, the motive medium cycle and the refrigerant cycle. The pressure energy of the motive steam is converted into kinetic energy in the motive steam nozzle of the steam-jet ejector. Steam of the refrigerant is drawn in from the evaporator of the adjoining mixing chamber by momentum exchange. The steam pressure in the evaporator is lowered as long as the refrigerant evaporates and the cold water cools down according to the required chiller capacity. Temperatures below 0 °C can be realised with this technology.

In the diffuser the motive energy of the motive steam and the refrigerant steam is converted back into pressure energy. The complete mass flow is compressed to the pressure level according to the saturation pressure of water at the re-cooling temperatures. Vapor is condensed in a spray condenser. The heat of condensation is transferred to the re-cooling cycle by a plate heat exchanger and the condensate is led back into the evaporator or into the condensate collecting pipe of the district heating system.

Since the refrigerant is water, one can omit a separation of the process into vapor, cold water, and re-cooling water systems. Spray condensers and flash evaporators (open or half-open processes) can be applied instead of heat exchangers. However, a closed SJEC process can be conceived as well, where a separation from the periphery is done by the use of a heat exchanger.

The performance characteristics of steam-jet refrigerating systems are different from that of other thermally driven chiller systems. The coefficient of performance (COP) depends very strongly on the condenser back-pressure and thus on the re-cooling water temperature. This is determined by the state of the ambient air and by the performance of the cooling towers. In mid-

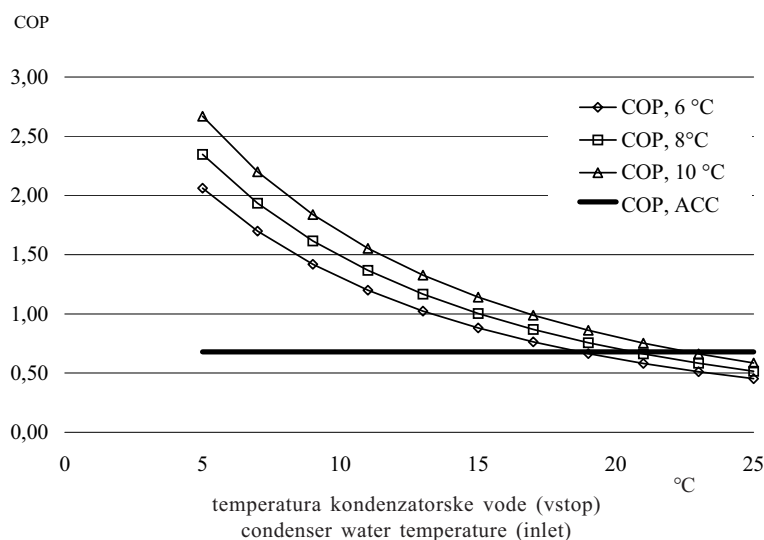

Sl. 2. Hladilno število (HŠ)  
Fig. 2. Coefficient of performance (COP)

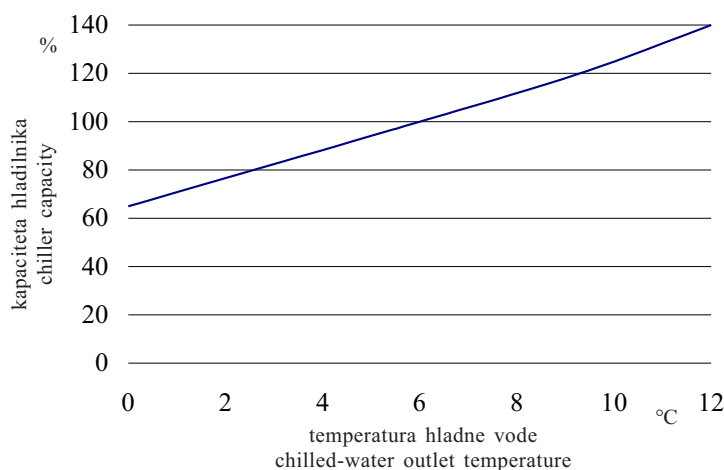

Sl. 3. Hladilna moč parnega ejektorskega hladilnega procesa  
Fig. 3. Chiller capacity of a steam-jet ejector chiller

je hladilno število HŠ parnega ejektorskega sistema (PES - SJEC) nižji od običajnih absorpcijskih hladilnih sistemov (AHS - ACC). Prek leta pa temperatura hladilne vode leži pod temi vrednostmi, tako da lahko dosežemo  $H\dot{S} > 1$ . Posledica tega je, da z nižjo energijo lahko pozitivno vplivamo na obratovalne stroške takega hladilnega sistema. Slika 2 kaže ta dejstva za različne razmere delovanja (podatki za hladilni sistem Brückenski ulici).

## 2 HLADILNI OBRAT BRÜCKEN V MESTU GERA

Da bi bolje uporabili sedanjo parno mrežo in nov obrat za proizvodnjo električne energije in toplote (KPET), je bil Fraunhofski UMSICHT določen, naj razišče prednosti kombinirane dobave toplotne energije in hladu. Od leta 1996 je v obratovanju nov postroj KPET ( $P_{el} = 76 \text{ MW}$ ,  $Q_t = 140 \text{ MW}$ ). Omrežje

summer with high air humidity and high outside temperatures, the coefficient of performance of an SJEC is lower than the COP of ACCs. Over the period of a year the re-cooling water temperatures, however, lie well below these conditions of the design case so that an average  $COP > 1$  can be reached. As a consequence, the lower demand of driving energy positively effects the running costs of the chiller plant. Figure 2 shows these facts for different operating conditions (data for the Brückenstraße chiller plant).

## 2 THE CHILLER PLANT BRÜCKENSTRASSE IN CITY OF GERA

In order to use the existing steam network and the new CHP plant (gas turbine combined cycle) of EGG in an improved way, Fraunhofer UMSICHT was engaged to investigate the benefits of a combined district heating and cooling supply. Since 1996 the new CHP plant ( $P_{el} = 76 \text{ MW}_{el}$ ,  $Q_{th} = 140 \text{ MW}_{th}$ )

daljinskega sistema povezuje 244 MW in ga sestavlja parni del (primarni del) in vročevodni del (sekundarni del). Obe omrežji sta povezani z 12 postajami. Glede na sedanje stanje (parni sistem v središču mesta) je tehnologija parnega ejektorskega hlajenja zelo obetajoča.

Uvodne raziskave so obsegale izračun potrebe po hladu in ocenitev posledic daljinskega ogrevanja in hlajenja na proizvodnjo električne energije in toplote (KPET). Z uporabo teh podatkov je bila izračunana potreba po hladu v mestu Gera.

Na podlagi teh podatkov so na Fraunhofer UMSICHT začeli z načrtovanjem hladilnega sistema s hladilno močjo 1,2 MW. Na podlagi rezultatov je Fraunhofer UMSICHT prišel do sklepa, da je uporaba parnega hladilnega sistema tehnično mogoča, stroškovno učinkovitejša v primerjavi z drugimi hladilnimi sistemi in tudi gospodarnejša.

Celotna hladilna zmogljivost hladilnega sistema se doseže s parnim ejektorjem in kompresijskim hladilnikom, vsakim s po 600 kW<sub>th</sub>. Ta delitev na eni strani zagotavlja optimalno delovanje in na drugi visoko zanesljivost delovanja. Ejektorski hladilni sistem (PES) sestoji iz dveh delov, od katerih vsak vsebuje tri parne ejektorje. Za zmanjšanje količine gonilne pare je vstavljen parni ventil, ki krmili tlak pare in kot posledico porabo pare glede na tlak v kondenzatorju. Preglednica 1 podaja povzetek podatkov sistema PES:

Preglednica 1. Imenski podatki delovanja Parne ejektorske hladilne enote v mestu Gera  
Table 1. Nominal Operation Data of the Steam-Jet Ejector Chiller Unit in City of Gera

hladilna moč PES chiller capacity SJEC	600 kW <sub>th</sub>
temperatura hladne vode chilled water temperature	6 / 12 °C
temperatura hladilne vode (dotok / odtok) re-cooling water temperatures (supply line / return line)	25 / 30 °C
temperatura okolice wet bulb temperature (design)	21 °C
parametri gonilne pare motive steam parameter (district heat)	143 °C, 3 bar
HŠ (imensko, povprečje) COP (nominal, assumed average)	0,55 / 1

Hladilni postroj je shematično prikazan na sliki 4. Dva hladilnika sta povezana vzporedno na strani hladne vode. Hidravlično sta povezana s hladnovodnim omrežjem in s hranilnikom hladne vode, tako da je prostorninski tok skozi uparjalnik kompresorskega cikla (KC - CC) in skozi uparjalnik parnega ejektorskega cikla (PES) nadzorovan neodvisno od prostorninskega toka do hladilnega obrata. Kondenzatorja PES in KC sta vezana zaporedno na hladno vodo, tako da dosežemo najmanjši pretok hladne vode. Parni ejektorski hladilni

has been in operation. The district heating network has a connected load of 244 MW and consists of a steam net (primary net) and a hot-water net (secondary net). Both nets are connected by 12 transfer stations. Due to the favorable prerequisites (a steam net up to the downtown area) the use of steam-jet ejector chiller technology was very promising.

The preliminaries for the development of a strategy included a cold demand survey and an estimation of the consequences of a combined district heating and cooling supply for the operation of the CHP plant. With this data the cold demand in downtown Gera was determined.

On the basis of this data Fraunhofer UMSICHT was entrusted with the planning of the first chiller plant with an installed chiller capacity of 1.2 MW<sub>th</sub>. As a result of the basic engineering Fraunhofer UMSICHT came to the conclusion that the use of a steam jet refrigerating system is technically possible and cost-effective compared to other chiller systems.

The total chiller capacity of the chiller plant is covered by a steam-jet ejector chiller unit and a compression chiller with 600 kW<sub>th</sub> each. This partitioning ensures optimal operating conditions for the SJEC and a high supply guarantee for the chiller. The SJEC consists of two stages, each of them with three steam-jet ejectors. To reduce motive-steam demand a motive-steam control valve is used to control the motive-steam pressure and, as a consequence, the steam consumption, depending on the condenser back-pressure. Table 1 gives a summary of the design data of the SJEC:

The chiller plant is shown schematically in Figure 4. The two chillers are connected in parallel on the cold-water side. They are decoupled hydraulically from the chilled water net by a cold water storage so that the volume flows through the evaporator of the CC and the flash evaporator of the SJEC can be controlled independently of the net volume flow to the chiller plant. The condensers of the SJEC and the CC are switched in series on the re-cooling water side to obtain a re-cooling water volume flow as low as possi-

proces (PES) je neposredno povezan z omrežjem EGG daljinskega hladilnega sistema in omrežjem parnega sistema. Hladilni krog, ki vsebuje hladilne stolpe, je bil hidravlično povezan s kondenzatorjem s ploščnimi prenosniki toplote.

ble. The SJEC is linked directly to EGG's district cooling system and district heating steam network. The re-cooling cycle containing the cooling towers was decoupled hydraulically from the condenser water cycle of the SJEC by a plate heat exchanger.

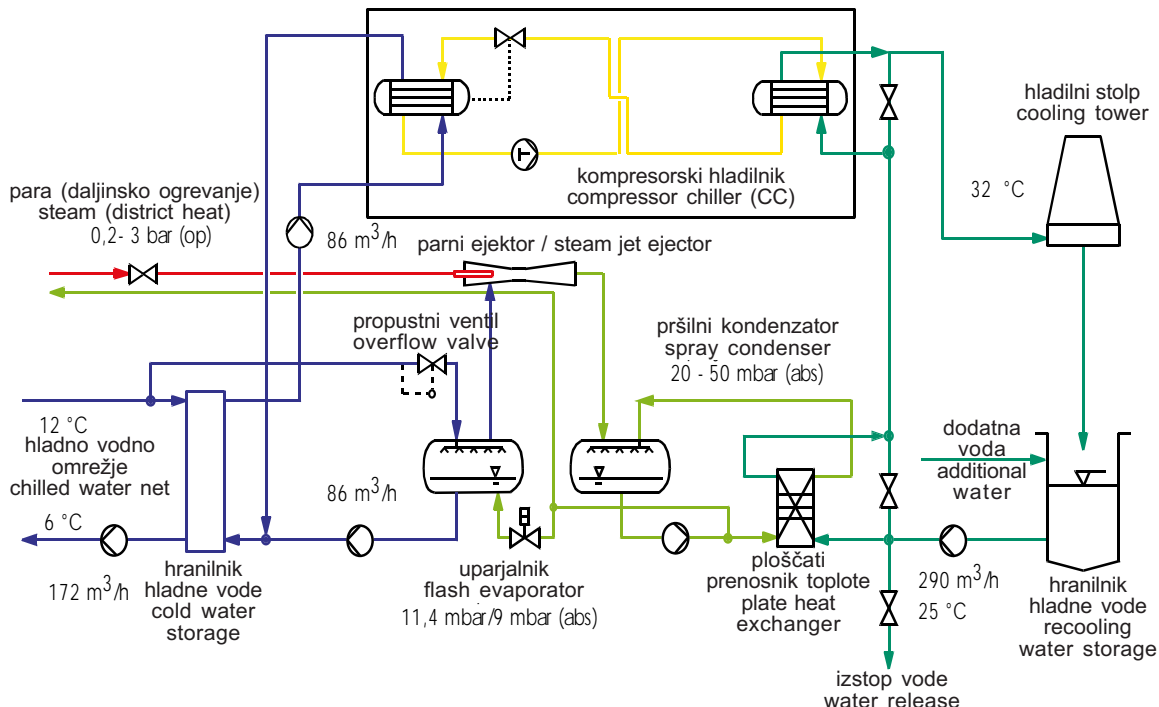

Sl. 4. Shema procesov hladilnega obrata  
Fig. 4. Process-Flow Scheme of the Chiller Plant

### 3 EKONOMSKA OCENA

Za ekonomsko oceno toplotno gnanih hladilnih procesov je treba upoštevati tako investicijske kakor tudi obratovalne stroške. Specifični investicijski stroški parnega ejektorskega hladilnega procesa (PES), vključno z dodatki za pilotni obrat v Geri so – za hladilni obrat v Brückenski ulici – malo višji kot stroški za absorpcijski hladilni sistem pri istih pogojih delovanja. V tej točki je treba upoštevati, da so za pilotni objekt stroški za proizvodnjo in načrtovanje razmeroma visoki. Poleg tega je bilo potrebno na pilotnem objektu izvesti številne meritve in nadzora. Izbran PES je samo en izveden hladilni obrat. V nadaljevanju je pričakovati nižje investicijske stroške v primerjavi z absorpcijskih sistemom (AHS) za enake robne pogoje, ki jih lahko dosežemo z masovno proizvodnjo in nadaljnjim optimiranjem hladilnega sistema.

Za ekonomsko oceno je treba upoštevati tudi obratovalne stroške. V tem primeru je prednost PESa zaradi večjega letnega deleža delovanja (HŠ). Specifično vrednost lahko izračunamo iz podatkov hladilne obremenitve in stanja zraka (vlažnosti in temperature). Za primer Gera naj bi letni delež delovanja dosegel vrednost približno 1. Kot

### 3 ECONOMIC EVALUATION

For an economical evaluation of thermally driven refrigerating processes both the investment costs and the running costs have to be considered. The specific investment costs of the SJEC including auxiliaries for the pilot plant in Gera are, for the chiller plant Brückenstraße, a little higher than the costs of an absorption chiller under the same operating conditions. At this point it has to be taken into account that for a pilot plant the expenditures for production (single manufacturing) and planning were still relatively high. Additionally, a lot of measuring and control techniques were equipped in the pilot plant. Furthermore, the chosen SJEC is a single manufactured chiller. In the future, lower investment costs compared to an ACC have to be expected for equal boundary conditions, which could be made possible by series production and further optimization in chiller-plant design).

For the economic evaluation of cold generation the running costs have to be taken into account as well. Here, advantages for the SJEC technology arise due to the larger annual mean COP. This specific value can be calculated from data on cooling-load duration curves and the state of the ambient air (humidity and temperature). For the supply case in Gera the annual mean COP was supposed to achieve a value of

rezultat pilotnega objekta in obratovalnih izkušenj je HŠ od 0,9 do 1 in je ugodna ocena za nadaljnje uporabe (število HŠ je za absorpcijske klimatske naprave (AHS) pogosto slabši od 0,6). Za izračun obratovalnih stroškov toplotnih hladilnih procesov uporabljajo naslednje predpostavke, ki so tipične za pridobivanje hladu v Nemčiji.

approximately 1. As a result of the pilot plant and the operational experiences an annual mean COP of 0.9 to 1 is a suitable estimation for further application (in reality the COP number of ACCs is often worse than 0.6). To calculate the running costs of thermally driven refrigeration processes the following assumptions are chosen, as these are typical for a cold supply in Germany.

Preglednica 2: Podatki za izračun obratovalnih stroškov (samo kot primer)

Table 2. Preliminaries to calculate operating costs (only as an example)

količnik f (razmerje med vodovodno in odpadno vodo) factor f (ratio of tap water to waste water)	3
poraba elektrike na kW hladilne moči electricity demand per kW re-cooling demand	0,025 kW <sub>el</sub> /kW <sub>th</sub>
voda (vključno s pripravo, kemični stroški) water (including make-up, chemical costs)	1,02 Euro/m <sup>2</sup>
odpadna voda waste water	1,53 Euro/m <sup>3</sup>
energija, elektrika energy rate, electricity	0,071 Euro/kWh
cena elektrike demand price tariff, electricity	102 Euro/kW/a
ure dobave hladu pri polni obremenitvi full load hours cold supply	1000 h/a
obratovne ure dobave hladu operating hours cold supply	5000 h/a
specifični stroški toplote specific costs of heat	20,47 Euro/MWh

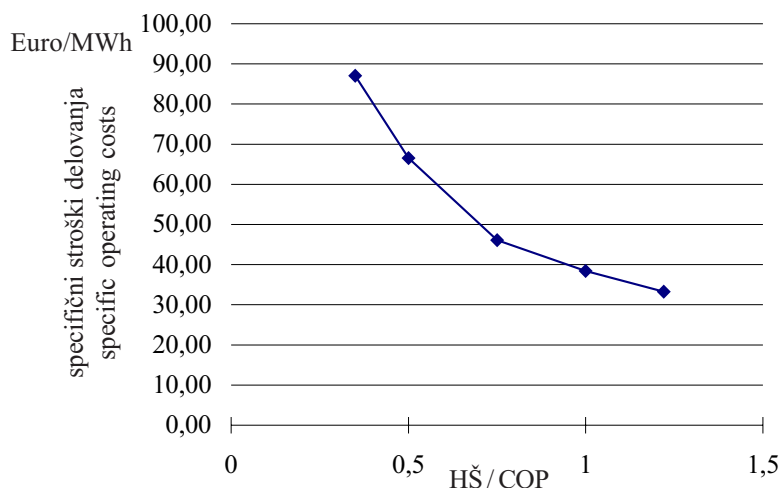

Sl. 5. Specifični stroški obratovanja toplotno gnanih hladilnikov

Fig. 5. Specific operation costs of thermally driven chillers

Ugotovimo močno odvisnost obratovalnih stroškov od HŠ. S parametri za EU-AHS (HŠ = 0,6) lahko napovemo specifične obratovalne stroške približno 60 Euro/MWh. Specifični stroški obratovanja za PES z letnim HŠ 0,9 (imensko delovanje 0,55) so okoli 25% nižji. Če povzamemo, lahko ugotovimo nižje stroške (obratovne in investicijske) za dane karakteristike porabnikov.

We see the strong dependence of running costs from the COP. With the parameters for an SE-ACC (COP=0.6) given here we have to assume specific operating costs of approximately 60 Euro/MWh<sub>in</sub>. The specific operating costs of an SJEC with an annual mean COP of 0.9 (nominal operating case 0.55), however, are around 25% lower. In summary, a lower total cold-supply cost (operating and capital costs included) can be realized for the given supply characteristics of the customers.

## 4 IZKUŠNJE DELOVANJA

Hladilni obrat deluje dve leti. V tem času ni prišlo do nobene nezgode ali motnje pri dobavi hladne vode. Poraba hladne vode je bila pričakovana gledano predvsem letno (sl. 6). Karakteristike delovanja parnega ejektorja so bile zelo dobre, predvsem kakovost nadzora hladne vode. Zadnje leto je bilo HŠ 0,62, kar je malo slabše od pričakovanega 1. Razlog za manjše HŠ je nižja temperatura povratne hladne vode, vmesno odpravljjanje ovir krmiljenja gonilnega parnega toka in ne optimalna konstrukcija ejektorjev.

Z instaliranim sistemom krmiljenja gonilne pare ni bilo mogoče znižati tlaka pare pod 0,2 bar (sl. 7). Zaradi tega do tedaj ni bilo mogoče uporabiti odličnih pogojev delovanja parnega ejektorja v zimskem času in ob spremembah. Za to leto pričakujemo boljše obratovalne rezultate zaradi boljše (oz. višje) temperature hladne vode, ker so

## 4 OPERATIONAL EXPERIENCES

The chiller plant has been in operation for two years. During this period no accidents or interruptions of the chilled-water supply occurred. The chilled-water demand corresponds to the expectations, especially concerning the year-round base demand for chilled water (Fig. 6). The operational characteristics of the steam-jet ejector are very good, especially the quality of the chilled-water supply control. For the last year the mean COP was 0.62, which is a little worse than the expected value of about 1. The reason for the reduced COP was the lower chilled-water return temperatures, in the meantime cleared constraints of motive steam flow control and a non-optimal design of ejectors are suspected.

With the installed motive-steam control systems it was not possible to lower the motive-steam pressure below 0.2 bar(op) (Fig. 7). Because of this it was not possible, until now, to use the excellent operation conditions of a steam-jet ejector in winter time and transfer period in a complete matter. For this year we expect better performance data due to a better (or higher) chilled-water return-line temperature, a new

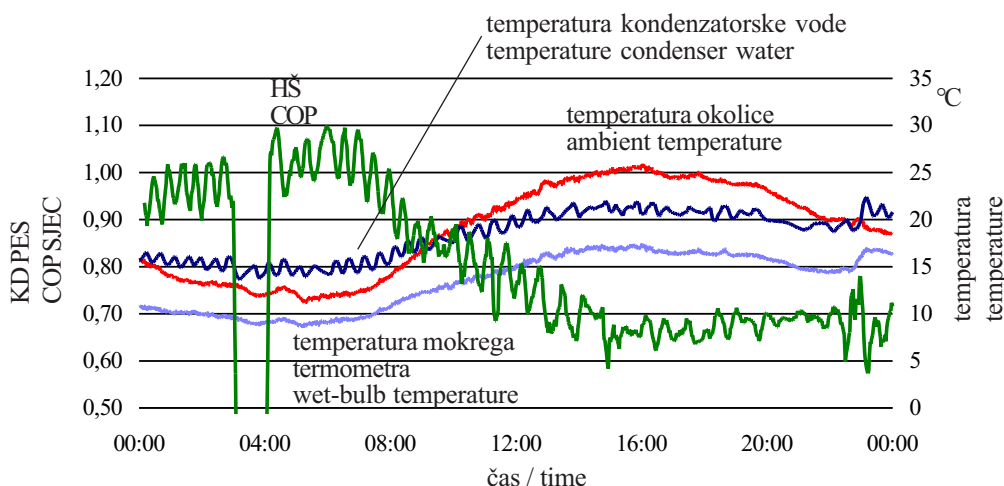

Sl. 6. Hladilni obrat v Brückenski ulici – HŠ in različne obratovalne temperature (podatki 19.5.1999)  
Fig. 6. Chiller Plant Brückenstraße – COP and different operation temperatures (data 19.05.1999)

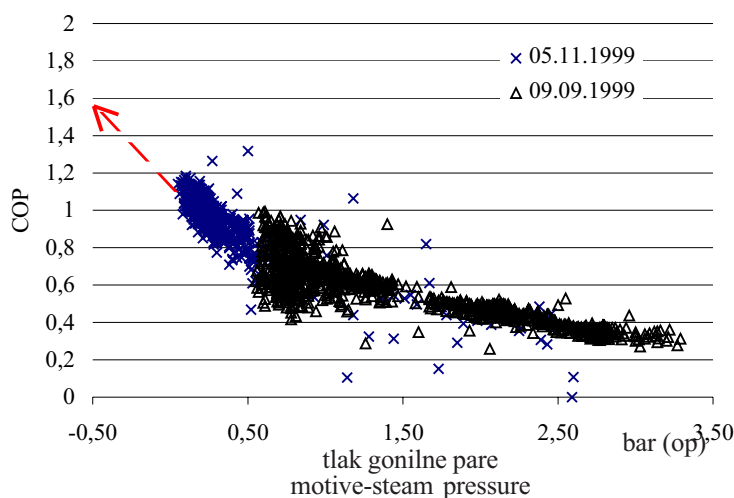

Sl. 7. Hladilnik v Brückenski ulici – HŠ v odvisnosti od tlaka pare (podatki 19.5.1999 in 09.09.1999)  
Fig. 7. Chiller Brückenstraße – COP as function of motive steam pressure (data 05.11.1999 and 09.09.1999)

bili januarja letos vgrajeni nov krmilni sistem gonilne pare in parne šobe.

motive-steam control system and modified motive-steam nozzles, which were changed in January of this year.

## 5 SKLEP

Izkušnje delovanja obrata iz prvih dveh let so zelo ugodne. Med prvo fazo delovanja in prvo fazo optimiranja so bili začetni problemi zelo hitro rešeni. Neučinkovito delovanje, ki je zelo znano pri večini toplotno gnanih hladilnih procesih, ni bilo ugotovljeno pri parnem hladilnem procesu. Dinamično obnašanje PES je primerljivo z drugimi običajnimi kompresorskimi hladilniki. V tem trenutku poteka optimizacija delovanja hladilnika predvsem HŠ in krmilnega sistema izklopa.

## 5 CONCLUSION

The experience from the first two years of the plant's operation are very positive. During the primary phase of operation and the first optimization phase the initial operational problems of the pilot plant could be solved very quickly. The inert operating response, well known from many heat-driven refrigerating processes was not observed for the steam-jet refrigeration system. In their dynamic behaviour SJECs are comparable to conventional compression chillers. At the moment the optimization of chiller operation, especially COP and switch-off control systems is in progress.

## 6 SIMBOLI 6 SYMBOLS

absolutno	abs	absolute
absorpcijski hladilni krog	AHS - ACC	absorption chiller cycle
kompresorski hladilni krog	KHK - CCC	compression chiller cycle
kombinirano daljinsko ogrevanje in daljinsko hlajenje	KDODH - -CDHDC	combined district heating and district cooling
kombinirana proizvodnja toplote, hladu in elektrike	KPTHM - -CHCP	combined heating, cold, and power
kombinirana proizvodnja toplote in elektrike	KPET - CHP	combined heat and power
hladilno število	HŠ - COP	coefficient of performance
daljinsko ogrevanje	DO - DH	district heating
razmerje dodatne vode	f	ratio additional water to released water
nadtlak	op	over-pressure
enojni učinek	EU - SE	single effect
parni ejektorski hladilnik	PES - SJEC	steam jet ejector chiller
temperatura	T (°C)	temperature

## 7 LITERATURA 7 REFERENCES

- [1] Noeres, P., Hölder, D., Althaus, W., B. Petzold (1999) Economic cold generation by steam jet refrigeration - experiences from a pilot plant. 7<sup>th</sup> International Symposium on District Heating and Cooling, Lund, Sweden, May 18-20.
- [2] Hölder, D., P. Noeres, W. Althaus, B. Petzold (1999) Fernkälteversorgung mit Dampfstrahlkältetechnik bei der Energieversorgung Gera. EUROHEAT & POWER - Fernwärme international 9/1998, 34-42.

Naslov avtorjev: Peter Noeres  
Daniel Hölder  
dr. Wilhelm Althaus  
Inštitut za okolje in varno  
tehnologijo  
Osterfelder Str. 3  
D-46047 Oberhausen, Nemčija

Authors' Address: Peter Noeres  
Daniel Hölder  
Dr. Wilhelm Althaus  
Fraunhofer - Institute for  
Environment and Safety  
Technology  
Osterfelder Str. 3  
D-46047 Oberhausen, Germany

Prejeto: 15.8.2000  
Received:

Sprejeto: 10.11.2000  
Accepted: