

Priprava motorja za tekmovalni razred

How to Prepare an Engine for Motorcycling's Supersport Class

Francišek Bizjan - Samuel Rodman - Ferdinand Trenc

Motorji za motorna kolesa v razredu Supersport so zanimivi za razvojne inženirje, ki razvijajo nove izdelke zaradi omejitev, določenih s predpisi. Ti praktično onemogočajo večje posege v motor, niti ne dopuščajo svobodne izbire delov za zamenjavo. Kljub temu, da se motorji pripravijo skoraj brez zamenjave delov, pa po drugi strani dosegajo velike moči. Ker se s tem spreminja velikoserijski izdelek, so lahko doseženi rezultati uporabni tudi pri razvoju motorjev. Predelani motorji ne dosegajo izrazito višjih vrtilnih frekvenc, imajo pa sorazmerno zelo visoke srednje dejanske tlake, med najvišjimi pri sesalnih motorjih. Prispevek prikazuje delni potek dogajanja pri predelavi motorja vključno s spoznanji o pomenu in zmožnostih računalniških simuliranj, ki se običajno uporabljajo pri močnejših tekmovalnih razredih.

© 2001 Strojniški vestnik. Vse pravice pridržane.

(Ključne besede: kolesa motorna, motorji ZNZ, karakteristike motorjev, programiranje računalniško)

Motorcycle engines used in the Supersport Class are interesting for engineers who develop new products because of the restrictions imposed by the regulations. These regulations do not allow major changes to the engine and restrict the choice of replacement parts that can be used. Nevertheless, the prepared engines achieve great power and the lessons learned during such an exercise can be put to good use in the development of mass-produced engines. These modified engines are not capable of significantly higher engine speeds, however, they can have a very high mean effective pressure, amongst the highest found in naturally aspirated engines. This article describes the steps involved in modifying an engine as well as our impressions of the importance and the possibilities of computer simulations in such types of racing.

© 2001 Journal of Mechanical Engineering. All rights reserved.

(Keywords: motorcycles, internal combustion engines, engine performance, computer programming)

0 UVOD

Že pri prvih korakih motorizacije je bila opazna tekmovalna strast med ljudmi, ki so upravljali stroje. Pravzaprav gre samo za tekmovalnost med ljudmi; med vozniki in skupinami tehnikov, ki pripravljajo vozilo. Vse do današnjih dni ta tekmovalna strast ni popustila, ampak se - nasprotno - povečuje. To je pripeljalo postopoma do vrste tekmovalnih razredov, ki so nastali predvsem zaradi tehničnih različnosti. Prav določeni okviri - predpisi pa omogočajo do neke mere enakovredne možnosti za vozila oziroma tekmovalce, ki tekmujejo v posameznih razredih ali kategorijah.

Tekmovalni razred Supersport je mlad in predstavlja motorje s prostornino 600 cm³, ki so malo predelani glede na vzeto osnovo oziroma velikoserijski izdelek. Prav zaradi tega so stroški predelave majhni, kar nadalje omogoča udeležbo na tekmovanjih širšemu krogu ljubiteljev. Pravzaprav tehnična izhodišča omogočajo razmeroma dostopno ceno za predelavo, če pa imajo posamezniki več znanja, se lahko dokažejo potem tudi z rezultati na progi.

0 INTRODUCTION

From the earliest days of motorised transport there has been a spirit of competition amongst people who work with engines. There has always been rivalry between drivers, technicians and all the people involved in preparing a vehicle. Over the years this rivalry has not decreased, on the contrary, it has increased. The result is a wide range of competitions that are organised for different classes of vehicle. These classes impose regulations in order to try and equalise the chances of the different vehicles that compete in the same class or category.

Motorcycling's Supersport Class is relatively new and consists largely of motorbikes with 600 cm³ engines that are only slightly modified versions of the mass-produced originals. Because the costs involved in rebuilding the engines are relatively low, large numbers of amateurs can take part in the races. This combination of low costs and limited modifications means that the better riders are able to demonstrate their skills through results on the racetrack.

Motor (Kawasaki Ninja ZX-R6 – slika 1) [1] je primer velikoserijskega izdelka, ki ima sodobno zasnovano in pomeni za tehnike izziv glede na dovoljene spremembe. Te sicer onemogočajo bistveno povečanje moči, s tem pa je zagotovljena sorazmerna izenačenost motorjev na stezi. Prav to pomeni zadovoljstvo gledalcev, tehnike pa spodbuja k novim rešitvam, ki omogočajo dosegati zmagovite lastnosti motorja.

1 SPLOŠNA PRAVILA ZA RAZRED SUPERSPORT

Pri hitrostnih tekmovanjih veljajo določena pravila, ki jih postavlja mednarodna organizacija za avto-moto šport. Tehnični del teh pravil dejansko vpliva na končne lastnosti motorja oziroma vozila. Glede na to so v razredu Supersport dovoljene naslednje splošne spremembe:

- Prostornina motorja je od 401 do 750 cm³ glede na število valjev; v praksi se uveljavili štirivaljni motorji s prostornino 600 cm³.
- Vsi deli motorja morajo biti serijski, izjema so deli in nastavitve, ki so poprej potrjeni od mednarodne organizacije na podlagi dokumentacije izdelovalca motorja.
- Obdelava delov motorja je mogoča le z odvzemanjem in še to do določene tolerančne meje – površinska obdelava.
- Dodatna toplotna obdelava ali površinska mehanska utrditev delov ni dovoljena.
- Ročni mehanizem mora ostati nedotaknjen, dovoljeno je le uravnoteženje delov.

The Kawasaki Ninja ZX-R6 [1] motorcycle in Figure 1 is an example of a mass-produced motorcycle of modern design that represents a challenge when it comes to making improvements and staying within the regulations. Significant changes to the engine's capacity are not allowed and, as a result, the bikes have roughly equal chances on the racetrack. This provides the spectators with exciting racing and spurs the motorcycle technicians to look for new ways to enhance the performance of the engine.

1 GENERAL REGULATIONS FOR THE CLASS SUPERSPORT

In motorcycle racing there are certain rules to be observed, these rules are imposed by the international organisation for auto-motor sports. The technical part of the rules places certain limitations on the engine. The Supersport Class allows the following general changes:

- The engine's capacity should be between 401 and 750 cm³, depending on the number of cylinders. The most usual engine configuration is four cylinders with a total capacity of 600 cm³.
- All the engine parts must be mass produced, with the exception of the parts and settings that are formerly approved by the international organisation after reviewing the documentation of the producer.
- Modifications to the engine parts are possible, but only by removing material, and then only to a limited extent. Some surface treatment is permitted.
- Additional thermal treatment or mechanical strengthening of the surfaces of parts is not allowed.
- The crank mechanism should remain unaltered although balancing of the parts is permitted.

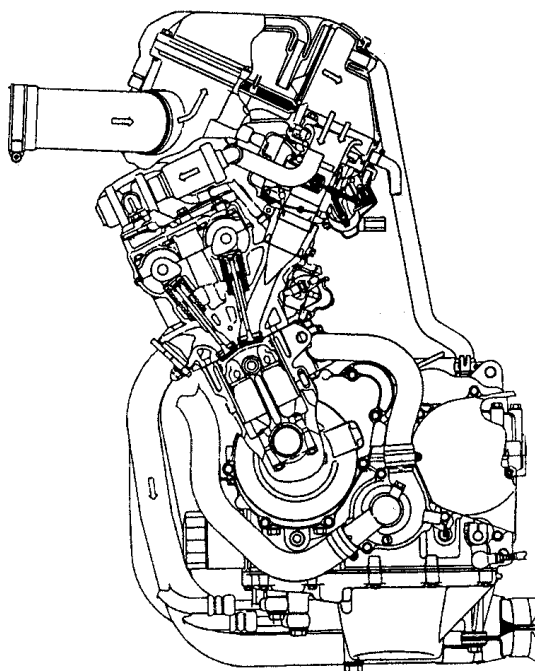

Sl. 1. Motor Kawasaki Ninja ZX-R6
Fig. 1. Engine of the Kawasaki Ninja ZX-R6

- Okrov motorja in oljna posoda morata ostati nedotaknjena.
- Sesalni sistem je omejen z določenim premerom uplinjača, okrov filtra in prostornina pred njim ostaneta nespremenjena, odstrani se lahko vložek.
- Vžigalni sistem je določen, omogočena je le predstavitev najvišje vrtilne frekvence do meje, ki velja za vse enako.
- Oblika izpušnega sistema, vključno z dušilnikom, mora ostati nespremenjena.
- Glavo motorja je mogoče deloma obdelati (glajenje), materiali morajo ostati enaki, v primeru zamenjave pa morajo biti homologirani, kar velja predvsem za ventile, sedeže in vodila ventilov.
- Dele krmilnega sistema je mogoče zamenjati za homologirane (odmični gredi, pogonska veriga, napenjalnik itn.).

Iz predstavljenih predpisov se vidi, da je mogoče zamenjati le malo delov motorja. Največ dela je zato v teh primerih namenjenega urejanju tokovnih razmer v glavi motorja.

2 PRIPRAVA MOTORJA

Izhodiščno stanje, kakor so: lastnosti motorja, pretočne karakteristike kanalov in delov, smo preverili na zavori, napravi za določanje tokov skozi kanale glave in z mehanskimi meritvami. Namen tega je bilo preverjanje znanih podatkov (pregl. 1) in pridobitev takih, ki običajno niso dostopni ([2] do [4]).

Glede na znano izhodišče in predelave, določene s predpisi, smo se odločili za naslednje spremembe na motorju:

- Glava motorja: obdelani so bili kanali in zgorevalni prostori, posebna pozornost je bila namenjena obdelavi površin, razširitvam kanalov in sedežev ventilov. Skrbno je bila nastavljena špranja med batom in glavo – izstiskovalna površina, ki opazno vpliva na lastnosti motorja.
- Okrov motorja z oljno posodo: dovoljena je načeloma le dodelava, ki ni bila dokončana s strojem, to je raziglanje delov.
- Ročni mehanizem: tu je dovoljeno le uravnoteženje delov ali pa izbira izvornih delov z enako maso.
- Krmilni mehanizem: mogoča je menjava odmičnih gredi z drugimi, ki pa se malo razlikujejo od serijskih, obdelava ventilov je bila simbolična zaradi omejene teže, zamenjane pa so bile vzmeti zaradi doseganja višjih vrtilnih frekvenc.
- Sesalni sistem: prilagojeni so bili prehodi na stikih delov, zamenjane šobe in preoblikovan vstop zraka v sesalno cev.
- Izpušni sistem: za primerjavo sta bila preskušena dva sistema, pri katerih sta bila spremenjena le zbiralnika.
- Hladilni sistem: potrebne spremembe so bile določene z najvišjo dovoljeno temperaturo vode; kar pomeni samo zamenjavo hladilnika.

- The engine block and oil pan should remain unaltered.
- The intake system is defined by the diameter of the carburettor, the filter frame and the air box in front of it. These parts should remain unchanged, only the filter element can be removed.
- The ignition system is defined, the maximum engine speed can be increased.
- The form of the exhaust system, including the silencer, should remain unchanged.
- The cylinder head can be partly remodelled by polishing, the materials should remain the same, in the case of changes they should be homologies, this applies to the valves, the valve seats and the valve guides
- Parts of the timing system can be exchanged for homologated parts, i.e. camshaft and timing chain.

The above conditions allow only a few changes to the engine parts. The studies are devoted mainly to flow conditions in the cylinder head.

2 PREPARATION OF THE ENGINE

The initial conditions of the engine, i.e. performance, flow characteristics of the port and parts were checked on a dynamometer, a device for determining the flow through the cylinder ports as well as by mechanical measuring. The aim was to check the known data (Table 1) as well as get some other information, which is normally not available ([2] to [4]).

With regards to the known facts and the modification conditions imposed by the regulations we decided on the following changes:

- Cylinder head – ports and combustion chamber were polished, special attention was given to surface preparation, widening of the ports and the valve seats. The piston clearance was carefully set, as was the extrusion surface, which significantly influences the engine performance.
- Engine block and oil pan - only final works are allowed, which were not done with the engine i.e. burring of the parts,
- Crank mechanism - only balancing of these parts is allowed, or the use of original parts with the same mass.
- Timing mechanism – it is possible to change the camshafts, but these are only slightly different from the mass-produced versions, changes to the valves are not significant due to the weight limit, the springs were replaced because of the higher engine speeds.
- Intake system - gangways on the connections of the parts were adapted, nozzles were replaced and the air inflow into the intake tube was changed.
- Exhaust system - two systems with different collector boxes were examined.
- Cooling system - changes were limited by the maximum allowed water temperature, which means the radiator was replaced.

Preglednica 1. Osnovne lastnosti motorja – tovarniški podatki

Table 1. Basic engine performance – factory data

<i>Lastnosti Properties</i>	<i>Vrednosti Values</i>
Tip motorja Engine type	4-valjni, 4-taktni Otto motor, 4 ventili na valj, 2 odmični gredi 4-cylinder, 4-stroke Petrol Engine, 4-valves per cylinder, 2 camshaft
Hlajenje Cooling	tekočinsko liquid
Premer x gib Bore x stroke	66,0 x 43,5 [mm]
Prostornina Capacity	599 [cm ³]
Kompresijsko razmerje Compression ratio	11,8 : 1
Moč Power	79,4 [kW] / 12000 [min ⁻¹]
Moment Torque	65,7 [Nm] / 10000 [min ⁻¹]
Napajanje z gorivom Fuel feeding	4 x uplinjači (Mikuni BDSR 36R) 4 x carburetors

Programska oprema

Po primerjavah med različnimi programskimi paketi ([5] do [7]), namenjenimi predelovalcem motorjev, smo izbrali paket, katerega teoretična podlaga je metoda karakteristik. Ker ta program izračunava predvsem nihajne pojave v ceveh, je nujno pri njegovi uporabi poznati izhodiščno stanje motorja, na katerem želimo opraviti spremembe. Vstopni podatki, potrebni za izračun, so [2]:

- Zahteve pri računanju, geometrijska oblika motorja, koti odmične gredi, geometrijska oblika sesalne cevi, geometrijska oblika izpušne cevi, pretočne razmere v kanalih in način dovoda goriva.

Računalniški programi, ki smo jih preverjali, zahtevajo v večini primerov izmerjene podatke motorja pri nekem začetnem stanju. Za začetno stanje se običajno vzame še nepredelan oziroma izviren motor. Nadaljnje zahteve so še oblika in mere sesalnih in izpušnih poti ter tokovne razmere v kanalih. To pomeni, da posredno določimo tudi dogajanja v valju, hkrati pa tudi predpostavimo, da se dogajanje v valju bistveno ne spreminja.

3 PRIMERJAVA LASTNOSTI MOTORJA PRED PREDELAVO

Osnovne lastnosti motorja so bile izmerjene na zavori (metoda pospeševanja mase). Na tak način se dejansko izmerijo dinamične lastnosti motorja pri pospeševanju. Zanimivo je, da tak način merjenja lahko prikaže večje vrednosti moči, kakor bi jih dobili pri standardnih (zavora na vrtinčne tokove) meritvah.

Tokovne razmere v sesalnem, izpušnem kanalu in uplinjaču so bile izmerjene na posebni

Software equipment

After comparing different software designed for engine rebuilders ([5] to [7]), we decided on a programme that is based on the method of characteristics. Since the programme first of all calculates oscillating procedures in the pipes, it is necessary to know the initial properties of the engine that is to be modified. The input data required for the calculation were: the geometry of the engine, the angles of the camshaft, the geometry of the intake pipe, the geometry of the exhaust pipe, the flow characteristics in the ports and the method of fuel intake [2]:

- The programme provides us with the calculated engine properties such as power, torque, mean effective pressure, volume effectiveness, graphical indication of the pressure flow, and velocity of the media.

The computer programmes that we examined in most cases required measured data taken from the engine at a particular starting point. The original engine is usually taken as the starting point. Further requirements include the form and the dimensions of the intake and the exhaust pipes as well as the flow conditions in the ports. This means that we indirectly determine the conditions in the cylinder and assume, at the same time, that the conditions in the cylinder are not essentially changing.

3 INITIAL COMPARISON OF THE ENGINE PERFORMANCE

Basic engine performances were measured on the dynamometer (mass accelerating method). This method measures the dynamic properties of the engine during acceleration. It is interesting that this method can give higher power values than those obtained by the classical (eddy-current dynamometer) measurements.

The flow conditions in the intake, the exhaust pipe and the carburettor were measured on a special

napravi. S tem so bili določeni pretočni koeficienti, določeni za celotno pot toka v kanalu (upoštevane so bile vse zožitve in razširitve ter ožina pri sedežu oziroma vodilu ventila), pri različni odmikih ventila.

device. The flow coefficients were defined for the total way of flow in the channel (all narrowings and widenings were taken into consideration as well as the narrowing at the valve seat, or guide) at different valve positions.

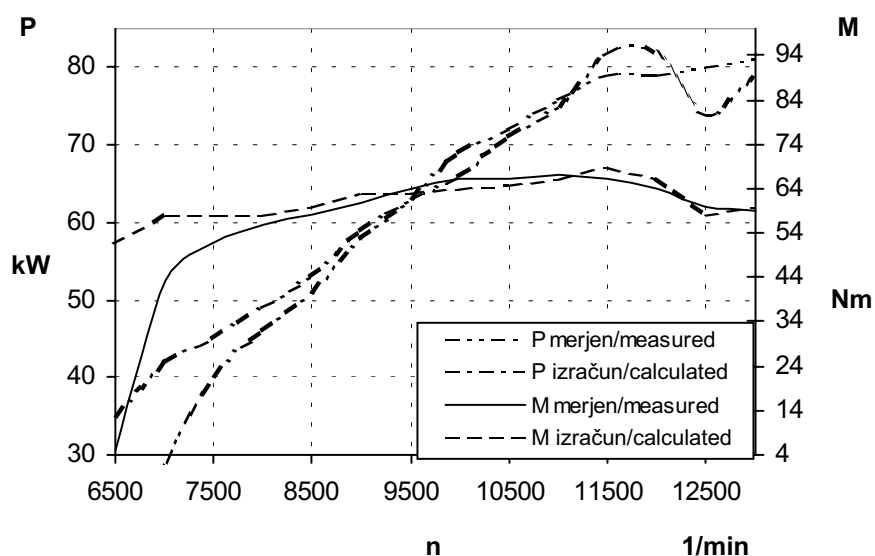

Sl. 2. Primerjava lastnosti motorja med izmerjenimi in izračunanimi rezultati (izvirno stanje)
Fig. 2. Comparison of the engine performance between the measured and calculated results (original)

Iz tako pridobljenih podatkov smo potem izračunali lastnosti motorja in jih primerjali z izmerjenimi vrednostmi na zavori, kar je prikazano na sliki 2.

Bolj kakor sam potek krivulje moči in momenta je zanimivo pogledati razlike med izračunanimi in izmerjenimi vrednostmi. Opazimo razmeroma dobro skladnost krivulj, kar velja splošno, prav tako pa vidimo tudi odstopke med izračunanimi in izmerjenimi vrednostmi, posebno na začetku in koncu krivulje. Večja odstopanja pri nižjih frekvencah so odvisna od računskega modela oziroma širine področja (vrtilne frekvence) računanja. Pri višjih vrtilnih frekvencah pa je vzrok za odstopanje deloma prevelika občutljivost ali pa nenatančnost matematičnega modela. Nenatančnost računanja je mogoče odpraviti z natančnejšim računanjem, kar program sicer omogoča, toda čas računanja se opazno podaljša. Po drugi strani je treba omeniti, da je uporabno področje vrtilne frekvence obravnavanega motorja približno v mejah med 8 in 12 000 min^{-1} . V tem področju je povprečna razlika med meritvami in izračuni približno 3 %, kar je povsem zadovoljivo.

Dolžina sesalnih cevi

Primerna dolžina sesalne cevi je dosežena takrat, ko prispe kompresijski val do ventila v trenutku največje hitrosti bata, to je približno pri 73° do 83° zavrtitve ročične gredi (RG) po zgornji mrtvi legi (ZML).

Poleg tega pa si želimo, da se poviša tlak v sesalni cevi tik po odpiranju in tik pred zapiranjem sesalnega ventila. S tem namreč

Using the above information we have calculated the engine's characteristics and compared them with the values measured with the dynamometer (Figure 2).

As well as the shape of the power and torque curves it is interesting to see the difference between the measured and the calculated values. The curves correspond comparatively well, but at the beginning and at the end we can see deviations between the measured and the calculated values. The larger deviation at low speeds is due to the calculation model, or the lack of accuracy in the area engine-speed calculation. At higher speeds the reason for the deviation is partly the great sensitivity, or inaccuracy, of the mathematical model. The inaccuracy of the calculation can be improved, the programme allows for this possibility, but the calculation time is longer. On the other hand, it should be mentioned that the relevant engine speeds are between 8000 and 12000 rev/min. In this range the average difference between the measurements and the calculations is approximately 3 %, which is satisfactory.

Length of the intake pipes

The intake pipe is long enough if the compression wave reaches the valve at the moment when the piston speed is at its highest, this moment occurs when the crankshaft has rotated 73° to 83° past top dead centre.

Our second aim was to increase the pressure in the intake pipe immediately after the opening and immediately after the closing of the intake valve. By doing this the possibility of media irruption in the intake channel

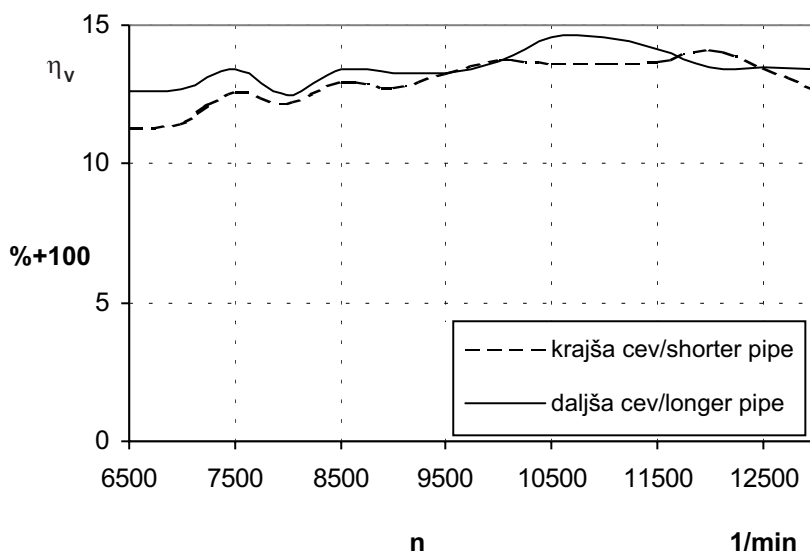

Sl. 3. Vpliv dolžine sesalne cevi na izkoristek polnjenja valja
 Fig. 3. Influence of the intake-pipe length on the cylinder's volumetric efficiency

zmanjšamo možnost vdora sredstva v sesalni kanal oziroma preprečimo povratni tok, ki je pogosto vzrok za slabe lastnosti motorja pri nizkih in srednjih vrtilnih frekvencah. Polnitev valja ali izkoristek polnjenja ni odvisen samo od dolžine, ampak še bolj od prereza cevi, hitrosti sredstva, spremembe prereza in pretočnih koeficientov. V prikazanem primeru je bilo mogoče vplivati na polnitev valja le z dolžino cevi in pa z obdelavo sten kanalov. Na sliki 3 je prikazan vpliv dolžine sesalnega kanala na izkoristek polnjenja valja. Ker želimo motor z večjo močjo pri višjih vrtilnih frekvencah, lahko ugotovimo, da je krajša sesalna cev ugodnejša rešitev. Pomanjkljivost take rešitve je ožje področje uporabne moči, kar lahko vpliva na vozne lastnosti. Dobra polnitev valja je kompromis med nastavitvami sesalne in izpušne strani in še drugih dejavnikov, ki jih v našem primeru ne moremo v celoti izkoristiti.

Vpliv krmilnih kotov odmične gredi

Kljub razmeroma majhnim spremembam kotov odmičnih gredi kažejo izračuni in preskusi, da se največja moč premakne v območje višjih vrtilnih frekvenc (sl. 4). Zanimivo je, da se moč pri tem bistveno ne spremeni, še več, se celo zelo malo spreminja. Delni vzrok za zamenjavo odmičnih gredi je tudi v spreminjanju kompresijskega razmerja oziroma zmanjševanju razdalje med batom in ventilom.

S spremembami kotov posežemo v nihajne pojave v sesalni in izpušni cevi. Njihov namen je zagotoviti, da pri odpiranju in zapiranju ventilov dosežemo čim manjše motnje toka v sesalnem in izpušnem kanalu. To pomeni, da se pri odpiranju in zapiranju sesalnega ventila pojavi čim manjši povratni tok v sesalni cevi. Med odprtjem izpušnega ventila pa naj bi zagotovili čim nižji tlak v izpušni cevi. S tem bi si zagotovili visok

is diminished and reverse flow is prevented, something which is often the cause of poor engine performance at low and medium engine speeds. The induction of the cylinder and the induction efficiency do not depend only on the length, they are also very dependent on the section of the pipe, the speed of the media, the change of the intersection and the flow coefficients. In our case it was only possible to influence the cylinder induction by changing the pipe length and treating the channel walls. Figure 3 shows the influence of the intake-pipe length on the cylinder induction efficiency. Since it was our aim to have an engine with greater power at higher engine speeds we can prove that a short intake pipe is an advantage. The disadvantage of this solution is that the power band is narrower, which can have a negative influence the motorbike's performance in real situations. The efficient induction of the cylinder is a compromise between the setting of the intake and the exhaust pipe as well as other factors, which in our case cannot be fully used.

Influence of the timing angles of the camshaft

In spite of relatively small changes in the angles of the camshafts, the calculations as well as the tests show that the highest power is shifted to the range of higher engine speeds (Figure 4). It is interesting, however, that the power has changed very little. Other reasons for changing the camshafts are to alter the compression ratio, or shorten the distance between the piston and the valve.

By changing the angles we influence the oscillation phenomena in the intake and exhaust pipe. The aim is to ensure that by opening and closing the valves we achieve the smallest possible flow disturbances in the intake and exhaust ports. This means that while opening or closing the valve the arising counterblow in the intake pipe is as weak as possible. During the opening of the exhaust valve there should be the lowest possible pressure in the exhaust pipe. In this way we can reach

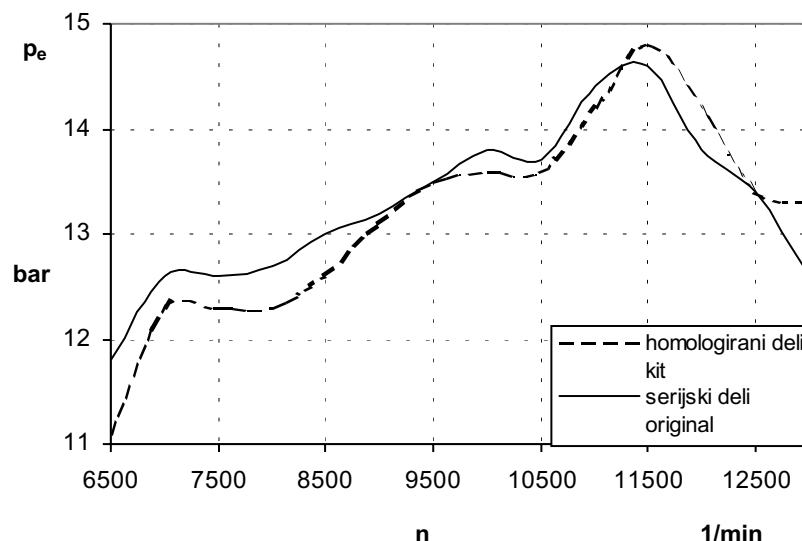

Sl. 4. Sprememba srednjega dejanskega tlaka v valju po zamenjavi odmičnih gredi
Fig. 4. Change of mean effective pressure in the cylinder after changing the camshafts

izkoristek polnjenja valja in čim nižjo količino zaostalih plinov.

high efficiency for the cylinder induction and the smallest possible quantity of residual gasses.

Vpliv razmerja zraka in goriva

Količina goriva v razmerju z zrakom vpliva na pripravo zmesi in nazadnje na lastnosti motorja. To razmerje je mogoče spreminjati z zamenjavo šob v uplinjačih, kar pa še ne zagotavlja enakomernega razmerja v delovnem področju motorja.

Ker pripravljamo tekmovalni motor, moramo zagotoviti stabilno razmerje v zmesi pri srednjih in visokih vrtilnih frekvencah. Zato moramo pred vsakim tekmovanjem upoštevati vpliv proge, vremena, voznika in zelenega razmerja zmesi in glede na vse te vplive določimo velikost šob. Vpliv različnih relativnih razmernikov zraka in goriva na moment motorja pa je prikazan na sliki 5.

Influence of the ratio air/fuel

The quantity of fuel and air influences the preparation of the mixture and subsequently also the properties of the engine. Changing the carburettor nozzles can change the air-fuel ratio, however, this does not ensure a constant ratio in the working range of the engine.

Since we are preparing a racing motorbike we have to ensure a stable ratio of the mixture at middle and high engine speeds. That is why, before each race, we have to consider the influence of the racetrack, weather, rider and the desired ratio of the mixture, and only after considering all these influences can we define the size of the nozzles. The influence of the different mixture ratios on the engine torque is shown in Figure 5.

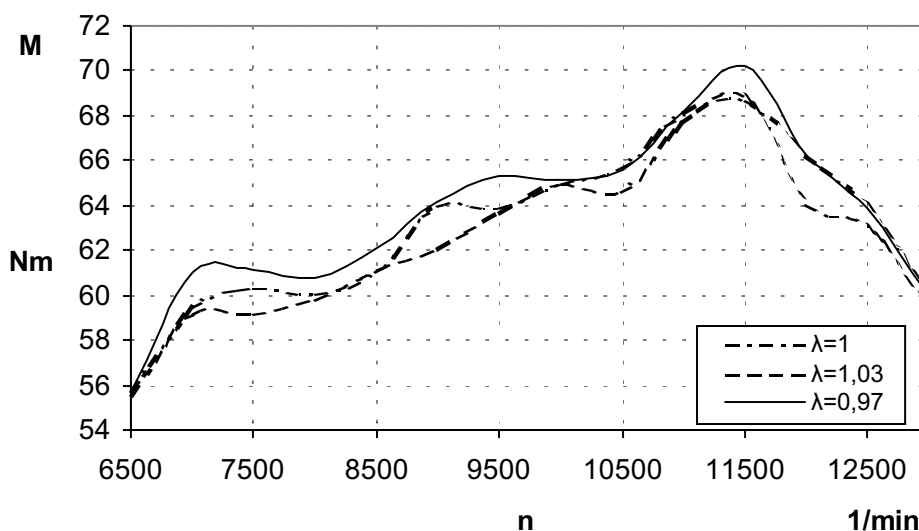

Sl. 5. Sprememba momenta zaradi različnega razmerja goriva in zraka zaradi različnih velikosti šob
Fig. 5. Change of torque due to different air-fuel ratios, resulting from different nozzle sizes

Vpliv izpušnega sistema

Izpušni sistem mora po pravilih sicer obdržati zunanjo obliko, kar pomeni, da se lahko notranje mere spreminjajo, posebej še mere zbiralnika. Nadalje izhaja iz teorije, da je za motorje z vrtilno frekvenco nad 8 do 10000 min^{-1} ugodnejša oblika izpušne cevi 4-1 (številke pomenijo število cevi, ki se združujejo). To pa tudi želimo zaradi doseganja največjih moči pri visokih frekvencah. Obliko zbiralnika, ki se nadaljuje in konča z izpušno cevjo, hkrati pa rabi kot dušilnik zvoka, je mogoče spreminjati, ker je prekrit z ovojnico glušnika in ta predstavlja zunanjo obliko. S tem dobimo proste roke za spreminjanje premera in deloma dolžine zbiralnika izpušne cevi.

S tem vplivamo na hitrost sredstva, valovne pojave in amplitudo valov, posebno še povratnih ali odbitih valov, ki spremenijo predznak ob spremembi prereza cevi. Vpliv premera in dolžine zbiralnika na moč motorja prikazuje slika 6.

Influence of the exhaust system

According to the regulations the exhaust system must keep the same external shape, however, this means that the internal dimensions can be changed, in particular, the collector. Furthermore, we know from the theory that for engines with a speed of 8000 to 10000 rev/min the 4-into-1 exhaust pipe configuration, where the four pipes leaving the engine are joined to provide a single exit pipe, is advantageous. This is also our desire in order to achieve the greatest power at high speed. The shape of the collector, which ends with the exhaust pipe and serves at the same time as a silencer, can be changed because it is covered by the muffler envelope that gives it its external shape.

In this way we influence the speed of the media, wave occurrence and the amplitude of the waves, especially the counter or rebounded waves, that change the sign when the pipe cross-section is changed. The influence of the diameter and the length of the collector on the engine's power is shown in Figure 6.

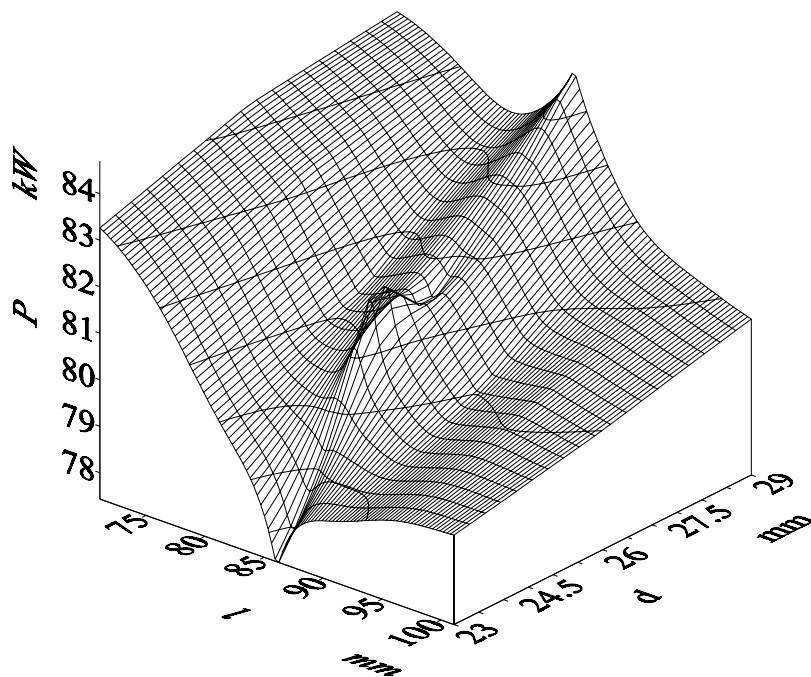

Sl. 6. Vpliv dolžine in premera zbiralnika na moč motorja ($n = 12000 \text{ min}^{-1}$)

Fig. 6. Influence of the collector length and diameter on the engine's power. ($n = 12000 \text{ rev}/\text{min}$)

4 PRIMERJAVA LASTNOSTI MOTORJA PO PREDELAVI

Dosežena skladnost rezultatov meritev in računanja, ki je prikazana na sliki 7, dokazuje, da se da do določene mere predelati motor tudi "za mizo". Pri tem je treba upoštevati zmožnosti uporabljene programske opreme in seveda njeno pravilno izbiro in kasnejšo uporabo. Uporabljeni programski paket se je izkazal za primerne pri predelavah motorja, pri katerem se spreminjajo le tokovne razmere v sesalnem in izpušnem sistemu. Slabša stran tega programa je precejšnja neobčutljivost na spremembe, ki niso

4 COMPARISON OF THE ENGINE PERFORMANCE AFTER MODIFICATIONS

The achieved symmetry of the measured and calculated results, shown in Figure 7, proves that up to a certain point it is possible to modify the engine "on the bench". Of course, the possibilities and limitations of the software have to be taken into account. The software we used proved to be suitable for modifications where only the flow conditions in the intake and exhaust system are to be modified. The disadvantage of the software is that it does not take account of the changes that are not connected

neposredno povezane s spremembo toka v ceveh. Ne nazadnje je treba reči, da so rezultati računanja neposredno odvisni tako od kakovosti vstopnih podatkov, ki jih zahteva program, kakor tudi od kakovosti meritev.

directly to flow changes in the pipes. At this point we should mention that the results of the calculations are directly dependent on the accuracy of the input data demanded by the software and the quality of the measurement.

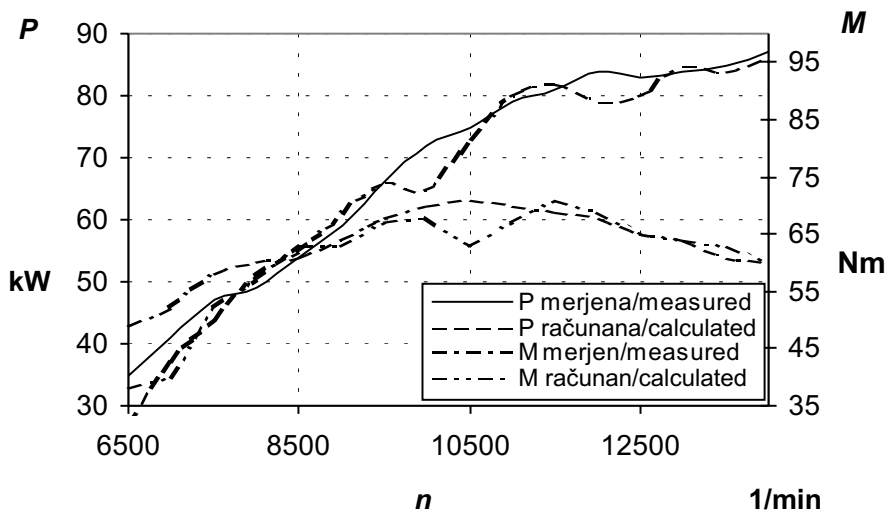

Sl. 7. Primerjava izmerjenih in izračunanih lastnosti motorja po predelavi
Fig. 7. Comparison of the calculated and measured engine performance after modification

5 SKLEP

Pri predelavi in nastavljanju motorja v kategoriji Supersport je treba narediti veliko majhnih korakov. Vsak korak mora pomeniti doseganje višjega srednjega dejanskega tlaka oziroma moči. Glede na razmeroma skromne dovoljene spremembe, je treba izkoristiti možnosti za čim bolj uspešno polnjenje valja in zmanjšanje trenja.

Uporaba računalniškega programa pri predelavi je dokazala, da je mogoče s primerno izbiro zagotoviti tudi zanesljivost izračunanih lastnosti po predelavi motorja. Izbrani program, ki zahteva dejansko kot vhodne podatke le geometrijsko obliko kanalov, je v tem primeru prava izbira posebej za manjša moštva, ki jim pogosto manjka nekaj znanja in ljudi. V prikazanem primeru je bilo mogoče prihraniti precejšnja sredstva, končni učinek pa se je izkazal pri prihranku časa, kar zagotavlja moštvu določeno prednost pred konkurenco.

5 CONCLUSION

When modifying and setting up a Supersport Class engine many small steps need to be undertaken. Each modification has to achieve either a higher mean effective pressure or an increase in power. Since only a few changes are allowed under the regulations, it is necessary to take advantage of all the possibilities to improve the induction and to diminish friction.

The use of a computer programme proved that it is possible, with a good choice of parameters, to achieve reliability for the calculated properties after the engine modification. The programme only requires input data relating to the geometry of the ports and, therefore, is a good choice for smaller teams that lack knowledge and manpower. In the example we have described we were able to save a lot of money as well as time, which gives the team an advantage over the competition.

6 LITERATURA

6 REFERENCES

- [1] Kawasaki Heavy Industries, Ltd. (1999) Kawasaki Ninja ZX-R5, '99 Racing kit manual, First edition: Jan. 14 (K).
- [2] Bizjan, F. (1996) Dvotaktni motor (Spreminjanje karakteristik motorja v teoriji in praksi), Ljubljana, samozaložba, ISBN 961-90450-0-9.
- [3] Dalton, J. (1989) Practical gas flow – techniques for low-budget performance tuning, MRP, GB, *Hartnolls Limited, Bodmin*, Cornwall, ISBN 0 947981 33 0.
- [4] Graham Bell, A. (1998) Four stroke performance tuning, Second edition, *Haynes Publishing Sparkford*, ISBN 1 85960 435 8.

- [5] Dynomation: Four cycle wave action simulator, (C) (1994) *V.P. Engineering INC.& Audie Technology INC.*, v. 2.0.
- [6] Performance trends: Engine analyzer Pro for Windows, *User Manual*, (1997) v.2.1.b.
- [7] Virtual 4 stroke, SAE version, *Optimum-Power Technology* (2000).

Naslov avtorjev: doc.dr. Frančišek Bizjan
mag. Samuel Rodman
prof.dr. Ferdinand Trenc
Fakulteta za strojništvo
Univerze v Ljubljani
Aškerčeva 6
1000 Ljubljana

Authors' Address: Doc.Dr. Frančišek Bizjan
Mag. Samuel Rodman
Prof.Dr. Ferdinand Trenc
Faculty of Mechanical Eng.
University of Ljubljana
Aškerčeva 6
1000 Ljubljana, Slovenia

Prejeto: 20.7.2001
Received:

Sprejeto: 7.12.2001
Accepted: