

Naprava s pnevmatično aktivno površino: Razvoj prototipa in Ljapunovova analiza stabilnosti

A Pneumatic Active-Surface Device: Prototype Design and Lyapunov Stability Analysis

Suzana Uran - Riko Šafarič - Tobias Winther

Pomanjkanje proizvodnih tehnik za premikanje in spreminjanje usmerjenosti (manipulacijo) velikega števila majhnih predmetov pomeni tehnološko oviro za tržni uspeh na različnih področjih mikro elektromehanskih sistemov (MEMS). V članku je predstavljen bistveno nov način avtomatizacije množične paralelne manipulacije majhnih predmetov. Raziskana je naprava s pnevmatično aktivno površino (NPAP). Ustrezna izbira sile, ki jo povzroča pihanje ali sesanje zračnega toka skozi cevke naprave z aktivno pnevmatično površino, povzroča želeno premikanje predmetov na aktivni površini naprave. Naprava omogoča veliko gibljivost in hitrost in jo lahko uporabimo za pozicioniranje, orientiranje, identifikacijo, sortiranje, podajanje in sestavljanje predmetov. Dodatno k temu lahko vodimo mnogo predmetov hkrati. Ta članek kratko opisuje eksperimentalno delo, opravljeno na prototipu naprave s pnevmatično aktivno površino.

© 2002 Strojniški vestnik. Vse pravice pridržane.

(Ključne besede: deli mali, manipulacija predmetov, polja pnevmatična, stabilnost predmetov)

The current lack of manufacturing techniques for very-high-volume handling of small objects presents a technology barrier to commercial success in various fields like micro-electro-mechanical systems (MEMS). A fundamentally new approach to automated, massive, parallel manipulation of small-sized parts is explored in this paper: the pneumatic active surface device (PASD). The appropriate choice of force, caused by blowing or sucking air-flow through the tubes of the PASD, is shown to cause objects that are placed on the array to be moved in ways that are useful. It offers great flexibility and speed and it can be employed to position, orient, identify, sort, feed, and assemble parts or objects. In addition, several objects can be controlled simultaneously. This paper briefly describes experimental work done on a PASD.

© 2002 Journal of Mechanical Engineering. All rights reserved.

(Keywords: small parts, objects manipulation, pneumatic fields, objects stability)

0 UVOD

Množična proizvodnja miniaturnih komponent kakor so integrirana vezja, mikro elektromehanski sistemi (MEMS) itn. zahtevajo bistvene izboljšave na področju manipulacije predmetov. Te komponente so izdelane na podlagi postopka mikroproizvodnje, ki izvira iz tehnologije (ZVI - VLSI). Le ta omogoča proizvodnjo tisočev ali milijonov komponent hkrati. Naprava s pnevmatično aktivno površino (NPAP) uporablja nov način avtomatizirane manipulacije predmetov. Namesto manipulacije posameznih predmetov (npr. z robotskim prijematlom [12]) s pomočjo naprave s pnevmatično aktivno površino premikamo mnoge predmete hkrati. Naprava s pnevmatično aktivno površino omogoča vzporedno

0 INTRODUCTION

Mass production of miniature components such as integrated circuits, micro-electro-mechanical systems (MEMS), etc., requires fundamental innovations in the handling of parts. These components are built using microfabrication processes derived from VLSI technology, which allows thousands or millions of components to be manufactured in parallel. A pneumatic active surface device (PASD) uses a new approach to the automated manipulation of parts. Instead of handling a single object directly, for example, with a robot gripper [12], a PASD can be used to move multiple objects simultaneously. This new automation device permits parallel and distributed, sensing and actuation, and

in porazdeljeno zaznavanje in aktiviranje in je še posebno primerna za manipulacijo serijsko mikroproizvedenih predmetov, katerih majhne izmere (manj kot milimeter) in veliko število ne omogočajo običajne manipulacije z robotskimi prijematli.

V zadnjem času so bile razvite mnoge podobne naprave:

1. Programljivo polje sil je matrika velikega števila programljivih točk mikrogibanja ([1] in [5]). Pri vodenju gibanja predmetov po programljivem polju sil je uporabljena strategija "ožajočih se vzorcev" ([1], [2] in [7]) ob uporabi analize ravnotežnega stanja ([1] do [3]). Naprava je opisana v [1] in [2] in ima pomembne lastnosti, to so: občutljiva je na poškodbe in nima vgrajenih zaznaval. Zato za premikanje predmetov po njej ni mogoča izvedba zadržane vodenja. Naš način uporablja zaznavala tlaka, ki se uporabljajo za zaznavanje predmeta na NPAP, zato omogoča zaznavanje predmeta na podlagi njegove ploskve, s katero se dotika pnevmatično aktivne površine. Iz tega razloga naš način omogoča izvedbo zadržanih tehnik vodenja.
2. Navidezno vozilo [4] je zgrajeno iz celic, ki predstavljajo mehanizem z dvema prostostnima stopnjama. Za vodenje vsake izmed celic je uporabljen zapleten postopek vodenja, saj je za vodenje vsake celice potreben mikroprocesor (MC68HC11). Vsaka celica je informacijsko povezana s preostalimi celicami s serijsko povezavo RS232. Nemogoče si je predstavljati, koliko komunikacijske in računalniške pomoči bi bilo potrebno za izvedbo matrike z nekaj sto tisočimi celicami, ki bi premikale mikroskopsko majhen predmet. Osnovna celica naše naprave (cevka in zaznavalo tlaka), ki je načrtovana za premikanje mikroskopsko majhnih delcev, je izvedena preprosteje, zato bi bil potreben en mikroprocesor (MC68000) za vodenje prek deset tisoč celic.
3. Prve mikroproizvedene celice in matrike na podlagi zračnega toka so bile predstavljene v [6], toda za njih ni poročil o uporabljenih strategijah vodenja predmetov po matriki. Naše tehnike vodenja omogočajo od oblike predmeta neodvisno razklenjeno in zadržano vodenje osnovnih premikov in usmeritev (translacija, rotacija) za toge in elastične predmete. Nekatera poročila o vodenju in manipulaciji predmetov na programljivem polju sil so v [1] do [3] in [7] in so delno vplivala na razvoj naših tehnik vodenja.
4. Mnoge skupine raziskovalcev MEMS so zgradile izvršilniške matrike za mikromanipulacijo, ki so običajno zgrajene iz 'gibalnih točk'. Naprave so zgradili prej omenjeni avtorji [1], [4] do [6] in v [8] do [11].

is particularly attractive for handling batch microfabricated objects, whose small dimensions (sub-millimeter) and large numbers do not allow conventional pick-and-place operations using robot grippers.

Recently, several similar devices have been invented:

1. The programmable force field – a massive parallel array of programmable micromotion pixels ([1] and [5]) – uses a control strategy called "squeeze patterns" ([1], [2] and [7]) with equilibrium analysis ([1] to [3]). The device described in [1] and [2] has a major disadvantage: it is susceptible to damage and has no integrated sensors. Therefore, closed-loop position-control methods cannot be used for moving objects on a surface with programmable force fields. Our approach uses pressure sensors for sensing an object on the surface of the PASD, which allows us to use object recognition from the footprint of the object sensed by the pressure sensors as well as closed-loop position techniques.
2. The Virtual Vehicle [4] uses a complicated control technique for each cell, for which a complete microprocessor (MC68HC11) is needed to control a two-degree-of-freedom mechanical mechanism. Each cell is linked to the other cells with a RS232 serial link. It is impossible to imagine how much communication and computer power would be needed in the case of an array of a few hundred thousand micromachined actuators (cells) used to carry near-microscopic objects. The basic cell (a tube and a pressure sensor) of our devices which is designed for carrying near-microscopic objects, is controlled in a simpler way: only one micro-processor (MC68000) would be needed to control over ten thousand cells.
3. The first airflow-based micromachined cells and arrays were presented in [6] but no control strategy for moving objects on the array was described. Our control techniques allow basic open-loop and closed-loop rigid and flexible object movements (translation, rotation, flip) that are independent of the object's shape. Some reports of the control and manipulation of objects on programmable force fields are reported in [1] to [3] and [7], and have been partly influential in the development of our control techniques.
4. Several groups of MEMS researchers have designed and built actuator arrays for micromanipulation that usually consist of "motion pixels". Devices were built by the previously mentioned authors [1], [4] to [6] and also by [8] to [11].

1 NAPRAVA S PNEVMATIČNO AKTIVNO POVRŠINO

1 PNEUMATIC ACTIVE SURFACE DEVICE

1.1 Načrtovanje prototipa

Prototipna naprava vsebuje množico vzporednih cevk, katerih konci predstavljajo gladko površino (aktivno površino). Na tej površini lahko objekt opazujemo in z njim izvajamo operacije manipulacije. Cevke piha oziroma sesajo zrak na površino ali z nje. Zračni tok skozi vsako posamezno cevko je krmiljen z uporabo dvopoložajnega ventila, ki vodi na površino zrak z nadtlakom ali pa zrak s podtlakom glede na atmosferski zračni tlak. Zračni tok zaradi nadtlaka potiska objekt stran od konca cevke, medtem ko podtlak generira akcijo sesanja oziroma premikanja objekta v smeri proti koncu cevke, ali pa objekt prisesa na površino. Med premikanjem objekta po površini se morajo posamezni ventili odpirati in zapirati v ustreznem zaporedju. Zračni tokovi pod in nad objektom in okoli njega spreminjajo lego objekta in pot njegovega premikanja na površini. Z ustrezno spremenjenimi zračnimi tokovi lahko dosežemo vzdolžno ali vrtilno premikanje. V vsaki cevki je montirano tudi zaznavalo zračnega tlaka med aktivno površino in ventilom. Če je podtlak pripeljan na cevko in če je vrh cevke pokrit z objektom, tedaj zaznavalo tlaka izmeri drugačno vrednost kakor v primeru, če je vrh cevke prost. Z branjem vrednosti zaznavala tlaka v vseh cevkah (ko je v vseh cevkah podtlak) se lahko določi lega objekta na aktivni površini. Računalnik prek ločenega elektronskega vezja obdeluje in prikazuje izhode zaznavala tlaka in hkrati krmili vse ventile cevk. Poenostavljeno shemo prototipa prikazuje slika 1, kjer je narisanih samo nekaj cevk, ventilov, zaznavala tlaka, vira podtlaka in nadtlaka, električne linije, krmilni mikroročunalnik in aktivna površina, po kateri se rokuje z objektom.

V naslednjih poglavjih bomo predstavili posamezne komponente prototipa obširneje. Celoten sistem NPAP prikazujeta sliki 2 in 3. Slika 2 prikazuje meritev lege dveh ločenih objektov na aktivni površini. Zgornji zaslon je povezan s kamero, ki je uporabljena zgolj za uporabnikov vizualni nadzor dogajanja na površini. Spodnji zaslon pa je povezan na osebni računalnik, ki se uporablja za komunikacijo človek - stroj in prikazuje izmerjeno lego objekta na površini.

Aktivna površina (slika 3a) je zgrajena iz 100 steklenih kapilarnih cevk z zunanjim premerom 0,4 mm, ki so zalite v blok z Lexan®-om in epoksidno smolo (slika 3b). Na površini cevke tvorijo šesterkotni vzorec zaradi čim bližjega pakiranja cevk v bloku (slika 2). Na drugem koncu so steklene cevke povezane s cevmi za dovajanje nadtlaka oziroma podtlaka.

Povezave zračnih vodov in zaznavala tlaka. Vsaka cev za dovajanje nadtlaka oziroma podtlaka gre na t.i. T-konektor, v katerem je vgrajeno zaznavalo tlaka. Iz T-konektorja vodi druga cev do ventila. Prostornina zraka

1.1 Prototype Design

The prototype device contains a bundle of parallel tubes, the ends of which make up a smooth surface (the active surface). This is the surface on which an object is observed and handled. The tubes lead air to and from the surface. The airflow through each tube is controlled with two-position valves, one valve per tube. In one position pressurized air is supplied to the tube, in the other position a vacuum is created, generating a sucking action. The pressurized air is used to push an object away, while the vacuum is used to pull an object or draw it to the surface. As the object moves, various valves are opened and closed as required. Air streams below, above and around the object modify the position of the object and the path that it follows. The air streams can be used to provide both translational and rotational motion. A pressure sensor is attached to each tube between the active surface and the valve. If a vacuum is created and an object covers the end of a tube, then the pressure in that tube will drop more than in an uncovered tube. By reading the pressure in each tube, while the tube is being evacuated, the location of an object on the surface can be identified. A computer that is connected to a separate electronics board is used to process and present the sensor outputs. The computer and the electronics board are also used to control the position of the individual valves. A simplified drawing of the prototype is shown in Fig. 1; the figure is schematic and shows only a few tubes, valves, pressure sensors, the vacuum, air and electrical lines, the controller, and the active surface where the part is manipulated. The actual prototype has 100 tubes.

In the following paragraphs each of the individual components of the system is described in more detail. The complete system is shown in Figures 2 and 3. Figure 2 shows the measurement of the position of two separate objects on the PASD. The upper screen is connected to a camera, which is only used for user's visual control. The lower screen is connected to a personal computer, which is used for man-machine communication and shows the measured position of the objects on the PASD.

Active surface: The active surface (Figure 3a) is built from 100 glass capillary tubes (outer diameter 0.4 mm) mounted in a block of Lexan® and epoxy (Figure 3b). At the surface the tubes are in the hexagonal pattern of closest packing (Figure 2). At the opposite end of the block the glass tubes are connected to vacuum/pressure tubes.

Air connections and pressure sensors: Each vacuum/pressure tube joins a T-connector onto which the pressure sensor is mounted. From the T-connector another tube goes to the valve. The air

v kapilarni stekleni cevki in cevi za dovajanje nadtlača oziroma podtlaka med aktivno površino in ventilom mora biti enaka za vse cevke, zato da se zagotovi čim bolj enoten odzivni čas vseh cevk. Zaznavala tlaka in aktuatorji ventilov so postavljeni drug zraven drugega v isti cevki, ki vodi na površino.

Ventili in zagotavljanje podtlaka in nadtlača.

Uporabljeni majhni dvopoložajni solenoidni ventili imajo dva vhoda in en izhod. Ventili so vgrajeni v ploščo, narejeno iz Lexan-a z notranjimi vodi za dovod podtlachnega in nadtlačnega zraka in skozi povezovalne luknje vodijo do T-konektorjev. Cevi za dovod nadtlačnega in podtlachnega zraka so zalite v blok z epoksidno smolo. Dovodni vodi za podtlachni in nadtlačni zrak so pritrjeni na vir podtlaka in nadtlača v pravih razdaljah, kar onemogoča nihanja tlaka v vodih.

volume (capillary glass tube plus vacuum/pressure tube) between the active surface and the valve is the same for each of the tubes to ensure a uniform response time for all the tubes. The pressure sensors and the valve actuators are collocated in the same tube that leads to the tube's open-end on the PASD.

Valves and air/vacuum supply:

The valves used are small, 3-way, 2-position, solenoid valves. They are placed on Lexan® boards with internal ducts for the air and vacuum supply and through holes for connections to the tubes leading to the T-connections. The vacuum/pressure tubes from the T-connectors are mounted using epoxy. The supply ducts are hooked up to air and vacuum manifolds at regular intervals to avoid pressure variations along the ducts.

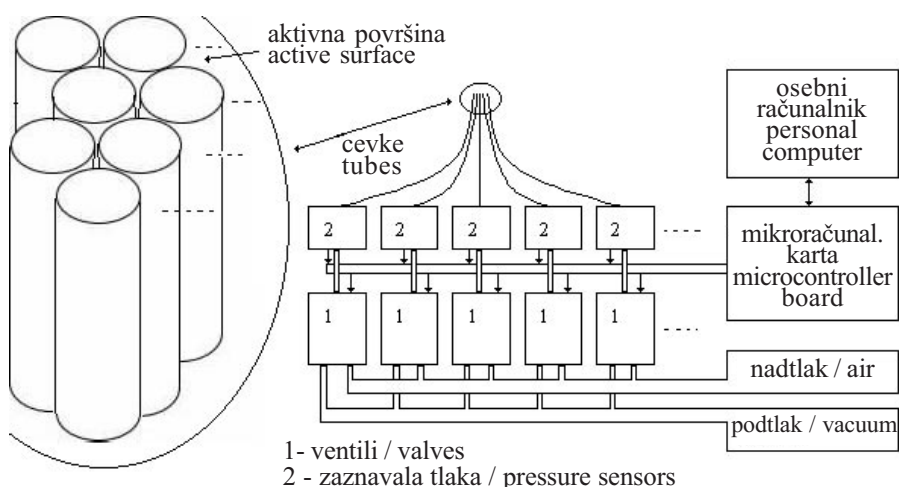

Sl. 1. Poenostavljena shema naprave s pnevmatično aktivno površino
Fig. 1. Simplified drawing of the active-surface device



Sl. 2. Celoten sistem naprave s pnevmatično aktivno površino
Fig. 2. The complete system of the pneumatic active-surface device

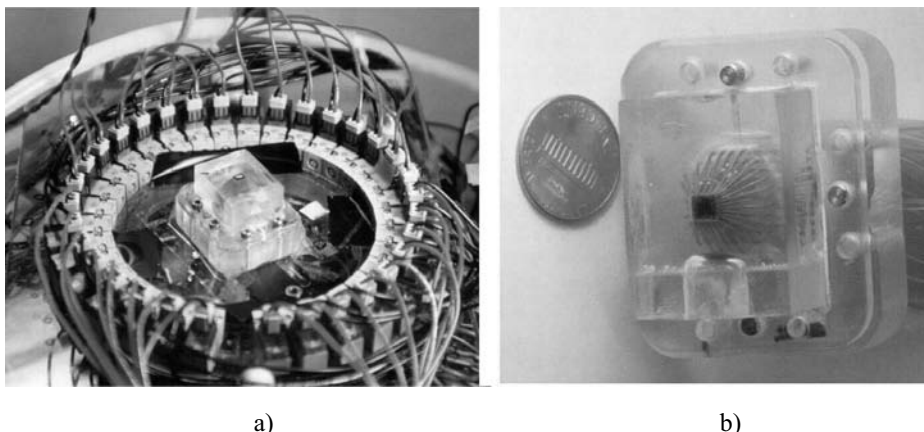

Sl. 3. Pogled na aktivno površino iz stotih steklenih cevk
 Fig. 3. A view of the active surface consisting of 100 glass tubes

Električne povezave. Ventili in zaznavala tlaka imajo ožičene električne povezave z elektronskim vezjem naprave. Elektronsko vezje vsebuje razdeljevalnike (multipleksorje), ki so uporabljeni za spreminjanje stanja ventilov, za naslavljanje posameznih ventilov in zaznavanje ter branje izhodnih vrednosti zaznavala. Ko se enkrat stanje ventila spremeni, ostane lega ventila nespremenjena do naslednje zahteve po spremembi. Samo en ventil oziroma eno zaznavalo tlaka je naslovljen v posameznem trenutku (času tipanja); samo naslavljanje je izvedeno vsakih 3 do 5 ms, kar je prehodni čas odziva posameznega ventila. To pomeni, da se veliko število ventilov lahko spremeni praktično v istem času.

Programska oprema. Karta električnega vezja se krmili iz navadnega osebnega računalnika prek programa, napisanega v jeziku C++. Program izrisuje na ekranu osebnega računalnika vzorec cevk aktivne površine in prikazuje, katere cevke so pokrite oziroma odkrite, ko je ukaz "vse cevke sesajo" izveden. V času zagona naprave se izvede t.i. kalibracijski podprogram, ki medsebojno inicializira zaznavala tlaka, ko je aktivna površina enkrat pokrita in drugič odkrita ob izvajanju ukaza "vse cevke sesajo".

1.2 Možnosti uporabe

NPAP se lahko uporablja za opazovanje (detekcijo lege in usmeritve), premikanje, pozicioniranje, držanje in aktivno spuščanje objektov različnih geometrijskih oblik in velikosti.

Nekatere osnovne funkcionalne zmožnosti naprave so naslednje:

- **Premikanje.** Gibanje objekta na aktivni površini se doseže s kombiniranimi akcijami sesanja in pihanja zraka skozi cevke. Objekt lahko dobro nadzorovano premikamo v ravnini aktivne površine: dve kartezijski in ena rotacijska prostostna stopnja, medtem ko je v drugih smereh to precej težje izvesti.
- **Držanje.** Silo zaradi sesanja cevk aktivne površine lahko uporabimo zato, da objekt prisesamo na površino.
- **Aktivno spuščanje.** Silo zaradi pihanja cevk aktivne površine uporabimo za aktivno "odlepitev" objekta od aktivne površine.

Electrical connections: The valves and the pressure sensors have electrical connections to a circuit board. The board contains a number of multiplexers, some of which are used for changing the state of the valves, others for addressing a particular sensor to get a reading from it. Once the state of a valve has been changed it remains in this state. Only one valve or sensor is addressed at a time, however, they are addressed very quickly (much faster than the valve response time, which is between 3 and 5 ms) meaning that in practice numerous valves can be changed almost at the same time.

Software: The board is controlled from a regular PC with a C++ program. The program displays the pattern of tubes on the screen and shows which tubes are covered (when a "suck-on-all" command is executed). Before starting the operation there is a calibration routine to calibrate the pressure sensors (relative to each other) by creating a vacuum with and without the active surface being covered.

1.2 Potential Applications

An active-surface device can be used to observe, move, position, hold and actively release objects of widely different geometric shapes and sizes.

Some of the primary functional capabilities are listed below:

- **Moving.** Motion is achieved by the combined action of pressurized air and/or suction. It is well controlled in one plane: two Cartesian plus one rotational degree of freedom, less well controlled in the other dimensions.
- **Holding.** The suction force can be used to hold a part up against the active surface.
- **Releasing.** Pressurized air can be used to actively release a part from the surface.

- **Opazovanje.** Identifikacija oblike in lokacije objekta na aktivni površini se lahko izvede v dveh dimenzijah na način, ko se izmeri podpritis ali različne vrednosti zračnega pretoka v cevkah

Med dodatne možnosti uporabe NPAP v primerjavi s tradicionalnimi prijemali lahko prištevamo še:

- Lahko upravlja praktično katero koli geometrijo objekta, kar pomeni, da je naprava zelo prilagodljiva in zmanjšuje potrebo po menjavah orodja pri operacijah "vzemi in spusti".
- Na aktivni površini lahko neodvisno premikamo več objektov hkrati.
- Silo aktivne površine na objekt lahko krmilimo glede na število cevk, ki sesajo ali pihajo na objekt.
- Aktivna površina lahko »prime« objekt na točno določenih mestih (sesanje na samo izbranih cevkah), ne pa povprek, kakor je to izvedljivo pri tradicionalnih sesalnih prijemalih.
- Lahko aktivno sprostijo objekt, kar je zelo pomembno pri zelo majhnih objektih, ki se radi "prilepijo" na tradicionalno prijemalo.

Nekatere mogoče uporabe predstavljene naprave so:

- **Prijemalo ali vpenjalna glava.** Naprava omogoča podobne funkcije uporabe kakor tradicionalna orodja robotskih rok (prijemalo, robotska »roka«, sesalno prijemalo in podobno). Orodje robotske roke ima poleg možnosti prijemanja in spuščanja objektov še vgrajeno možnost usmerjanja v treh prostostnih stopnjah. Na primer, robotska roka z dovolj velikim prostorskim dosegom bi se lahko uporabila za premikanje naprave pnevmatične aktivne površine kot orodja na vrhu robotske roke. Takšna kombinacija robotskega orodja bi se uporabila za »prijem« objekta manjšega od 1 mm. Objekt na pnevmatični aktivni površini, kot del orodja robotske roke bi se nato premaknil v želeno lego, kjer bi dosegel tudi želeno usmerjanje in nato se aktivno spustil (odlepil) od aktivne površine, pri čemer bi premagal površinske sile med aktivno površino in majhnim in lahkim objektom.
- **Tekoči trakovi in površine.** Sistem tekočih trakov ali površin lahko zgradimo iz naprav s pnevmatično aktivno površino primernih velikosti in oblik. Vsak objekt, ki ga premikamo po takšnem sistemu, je sledljiv v vsakem trenutku in ne potrebuje vodil ali prekinitev na ovinkih. Ena stvar, ki jo običajni sistemi s tekočimi trakovi ne zmorejo, zmore pa jo naprava s pnevmatično aktivno površino, je, da se lahko različni objekti na aktivni površini pomikajo v različnih smereh (tudi nasprotnih) z različno hitrostjo. Namesto izraza tekočih trakov je tukaj bolj umestno govoriti o "aktivni površini". Dodatna prednost aktivne površine je, da se lahko objekti na površini tudi usmerijo in »pritrdijo« na zelenem mestu brez kakršnih koli posebnih dodatnih orodij ali pripomočkov na površini. To omogoča prilagodljivo sestavljanje, kjer se eden izmed objektov ustavi za potrebe sestavljanja, preostali

- **Sensing.** The shape and location of a part can be identified in two dimensions based on either the vacuum achieved in the different tubes or on airflow rates.

Some of the additional benefits of the device in comparison with a traditional gripper are:

- It can handle almost any geometry, i.e. it is very flexible and reduces the need for tool changes.
- Multiple parts can be moved independently of each other at the same time.
- A controlled force can be applied, depending on the number of cells pulling and pushing.
- It can grip objects in desired locations (by only sucking on selected tubes); not indiscriminately "all over" like a traditional suction-cup.
- It can actively release a part, this is particularly important for very small objects that tend to stick to traditional grippers.

Some of the potential applications are listed below:

- **Gripper or jig.** The device can perform a similar function to a traditional end-effector (gripper, robot "hand", suction-cup device or the like) on a traditional robot arm. However, besides gripping and releasing the end-effector has an inherent three degrees of freedom build into it. For example, a robot with a large spatial motion capability can be used to move the PASD around as an end-effector. The end-effector is moved to the part and used to grip it. The coarse motion system is then used to move the part close to the desired location, where the part is reoriented and repositioned on the active surface until it has the desired position, at which point the part is released actively overcoming the surface forces between the active surface and the part.
- **Conveyer belts and conveyer surfaces.** Conveyer systems can be built using active surfaces of suitable sizes and shapes. Each part being moved can be tracked at all times and no guides and no discontinuities at turns are required. One thing that the active surface can do that a normal conveyer cannot is to move each part at a different speed and in a different direction. It is even possible to have different pieces moving in opposite directions on the same conveyer belt. The term conveyer surface is used for this kind of device. Another benefit of the conveyer is that parts can be oriented and "clamped" in place while a process (e.g. assembly) takes place without hard fixtures. This makes it ideal for flexible assembly; when one part has stopped for assembly other parts are able to move on.
- **Reduced friction surface,** replacing wheels, roller

- objekti pa se še zmeraj prosto premikajo po površini.
- Zmanjšanje površine trenja. Z aktivno površino lahko nadomestimo kolesa, kroglične ležaje itn. Tako kakor pri magnetno lebdečih vlakih, lahko NPAP zmanjša trenje med objektom in okoljem, da se izvede učinkovitejši transport. Aktivna površina z vpihavanjem zraka med objekt in površino zmanjšuje trenje med njima.
 - Sestavljanje. NPAP se lahko uporabi tudi za sestavljanje. Na primer: predstavljajmo si situacijo, kjer se mora objekt A namestiti na ali v objekt B. Objekta A in B se premikata in pravilno usmerjata na dveh premikajočih se površinah na dveh ravneh z višinsko razliko med njima, ki je večja od višine spodnjega objekta. Krmilnik obeh aktivnih površin izračuna lego in usmeritev obeh objektov ter nato izvede medsebojno približevanje obeh objektov po najkrajši poti. Ko se objekta poravnata drug ob drugem, se objekt B z "zgornje" aktivne površine prestavi na spodnji objekt A in nato po spodnji površini odpelje do naslednjih delovnih operacij. Na ta način se lahko posamezni deli (objekti) sestavljajo med seboj v kakršni koli usmeritvi in na katerem koli mestu vzdolž obeh aktivnih površin.
 - Sortiranje. Napravo lahko uporabimo za sortiranje razsutih objektov, razpršenih po površini v primeru, da predstavljena naprava lahko zaznava razlike med posameznimi objekti. Te razlike so lahko variacije v velikosti ali obliki ali pa npr. razlike magnetnih lastnosti objektov, kar je seveda odvisno od narave objekta in tipa aktivne površine. Informacije z zaznaval se v krmilniku uporabijo za določitev poti individualnih objektov, s čimer dosežemo osnovo za sortiranje.
 - Usmerjanje objektov / podajanje objektov. V primeru, ko zaznavala zaznajo razliko med različnimi stranmi objekta, se lahko objekti sortirajo glede na to, na kateri strani trenutno ležijo na aktivni površini. Če ležijo na nepravi strani, jo lahko naprava s pnevmatično aktivno površino obrne na pravo stran. Ker se vsak posamezen objekt lahko vrti sam okoli sebe na aktivni površini, ga je mogoče usmeriti na uniformirani način, ki je kasneje uporabljen v nadaljnjem proizvodnem postopku.
 - Rokovanje z gibljivim materialom. Z napravo s pnevmatično aktivno površino lahko nadomestimo vrteče se valje pri strojih za manipulacijo papirja in tekstila. Lega materiala je ob uporabi aktivnih površin znana ves čas, zato lahko ob vsakršni neželeni spremembi smeri pomika materiala izvedemo popravek premika gibljivega materiala, preden pride do zastoja. Tanke velike površine naprave s pnevmatično aktivno površino lahko nadomestijo velike vrteče se valje in druge premikajoče se sestavne dele sedanjih strojev za premikanje gibljivih materialov, ki zahtevajo med drugim tudi vzdrževanje (npr. mazanje).
 - Površina zaznavanja. Zmožnost zaznavanja naprave lahko v posameznih uporabah postane najpomembnejša. Na primer: mnogo prijemal pri svojem delovanju moti pogled umetnega vida, tako bearings, etc. In the same way that magnetically elevated trains provide a reduced-friction environment for efficient transportation, any active surface can provide a reduced-friction transportation surface by providing sufficient "repelling" force towards the object in motion.
 - Assembly. The device can perform assembly operations. For example consider a situation where a part A is to be inserted into a part B. If there are two opposing conveyer surfaces (with a clearance larger than the height of A + B) then type-A parts can be feed onto one surface while type-B parts are fed onto the other. The conveyer surfaces sense the location of each part and feed that information to a controller that calculates how the parts should be aligned in the fastest possible way and controls the conveyer surface to achieve this alignment. Once aligned, the parts are assembled by rejecting one part from one surface and sending it towards the other (preferentially from "top" surface to "bottom" surface) and then moving on to the next operation. In this way parts can be assembled in any orientation and at any place along the two conveyer surfaces.
 - Sorting. The device can be used for sorting loose parts that are spread over the surface if the device is capable of sensing the differences between the different parts. These differences could be variations in size or shape or differences in the magnetic properties, all depending on the nature of the part and the type of active surface. Information from the sensors can be used to determine the direction in which the individual parts are moved, thus forming the basis of sorting.
 - Parts orientation / parts feeding. If the different sides of the parts look different (or feel different to the sensors in the array) the parts can be sorted according to the down facing surface. If the wrong side is up the device can flip the object. As each part can be rotated individually parts with the right side up can be oriented within the plane and presented in a uniform way, for example, to a production system.
 - Flexible materials handling. There are several benefits of replacing rollers in paper-and-textile-handling machines with active surfaces: the position of the material is known at all times, if the material deviates from the desired direction corrective action can be taken before the system jams. Thin sheets of active surfaces can replace large rollers and there are no moving parts that require maintenance (e.g. lubrication).
 - Sensor surface. The sensory capabilities of the system can, in some applications, become the most important attribute. For example, many grippers obstruct the view for a machine-vision system,

da sistem krmiljenja v tem primeru izgubi zmožnost krmiljenja lege v sklenjeni zanki. Če je prijemalo hkrati tudi zaznavalo lege, lahko ta problem zlahka odpravimo. V drugih okoliščinah bi lahko merjenje geometrijske oblike objektov (merjenje kakovosti), ki se premikajo po NPAP, izvajali kar med premikanjem objekta do črte sestavljanja, kar omogoča zelo izbrano rešitev.

- Delovna površina. Če so posamezne točke (odprtine) NPAP zmožne sprostiti različne kemikalije (plin, barvila, kemični reaktanti), je lahko aktivna površina zmožna prenosa premikajočega se objekta. Še posebej je pomembno, da je lahko obravnava objekta različna v odvisnosti od lokacije, torej so lahko posamezni deli objekta obravnavani na različne načine.

2 KRMILJENJE LEGE TOGIH PREDMETOV

Raziskali smo razklenjene, navidezno sklenjene in sklenjene strategije krmiljenja gibanja togih predmetov na napravi s pnevmatično aktivno površino (NPAP). Razklenjeno krmiljenje lege pomeni premikanje predmeta po površini NPAP brez zaznavanja lege predmeta. Čeprav je lega predmeta neznana, je predpostavljeno, da se bo predmet ustavil v želeni legi. Odprtozračno vodenje je pogosto uspešno, toda občasno se predmet zatakne na površini NPAP ali pa dejanska izvedba gibanja odstopa od želene. Iz tega razloga so bili razviti znančni postopki krmiljenja. V primeru navidezno znančnih postopkov vodenja se preverja lega predmeta le v končni legi giba, ne pa tudi v vmesnih korakih. Pri znančnem krmiljenju se natančna lega predmeta določa pogosto in se uporabi kot znančna informacija za položajno krmilo. S pomočjo znančnega krmiljenja se je bilo mogoče izogniti problemu zataknitve predmeta na NPAP, hkrati pa je mogoče tudi zaznati, ali ni morda predmeta odpihnilo z naprave. Znančni postopek krmiljenja je tudi bolj robusten za motnje, kakor so sprememba vhodnega tlaka v napravo.

Želena so tri različna osnovna gibanja predmeta:

- translacija predmeta,
- rotacija predmeta v ravnini naprave in
- obračanje predmeta.

Vsa tri osnovna gibanja predmetov so izvedena s tremi prej opisanimi strategijami krmiljenja. Za vsako vrsto gibanja in za vsak način obstaja mnogo različnih izvedb, npr. obstaja več različnih načinov za translacijsko gibanje. Zato lahko z ustrežno izbiro načina krmiljenje prilagodimo lastnosti predmeta, ki ga želimo premikati.

2.1 Analiza stabilnosti po Ljapunovu

Fizikalne osnove premikanja predmeta na PNAP so razložene na sliki 4. Razlika tlaka med cevko,

which makes closed-loop control very difficult. If the gripper is also the sensor system then this problem is eliminated. In other circumstances, measuring the geometry of parts as they pass by can be an important task (e.g. in quality inspection) and building a conveyor surface into an assembly line can provide a very elegant solution to this need.

- Processing surface. If some of the pixels (orifices) can discharge various chemicals (gases, dyes, reactants, etc.) the surface can be used to process the object being handled. Most importantly, the treatment can differ depending on the location, so some parts of the object get one treatment while other parts are treated differently.

2 POSITION CONTROL OF RIGID OBJECTS

We have been exploring open-, quasi-closed- and closed-loop control strategies for the motion of rigid objects on active-surface devices. Open-loop control is the movement of an object on the surface of a PASD without sensing the position of the object. Although the position of the object is not known it is assumed that the object will stop in a desired position. The method often works, but occasionally the object gets stuck on the surface or deviates from the desired track. Therefore, closed-loop control has been developed. In the case of quasi-closed-loop control the location of the object is verified at the end of the motion path only, not during any intermediate steps. In closed-loop control the exact position of the object on the surface is measured frequently and the current position of the object is used as closed-loop information for the position controller. With closed-loop control it has been possible to avoid problems relating to objects getting stuck and it is possible to detect if an object has been blown away. This type of control is also more robust in terms of disturbances such as changes to the input pressure of the device.

Three different, basic motions of a single object are desired:

- translation
- rotation
- flipping

Each of these motions can be addressed using one of the three basic approaches mentioned above. For each type of motion and each approach there are many different implementations, for example, there are many different approaches for open-loop translational motion. Furthermore, the nature of the object to be handled will influence the approach taken.

2.1 Lyapunov stability analysis

The basics of how an object is moved on the surface is explained in Figure 4. The difference in the

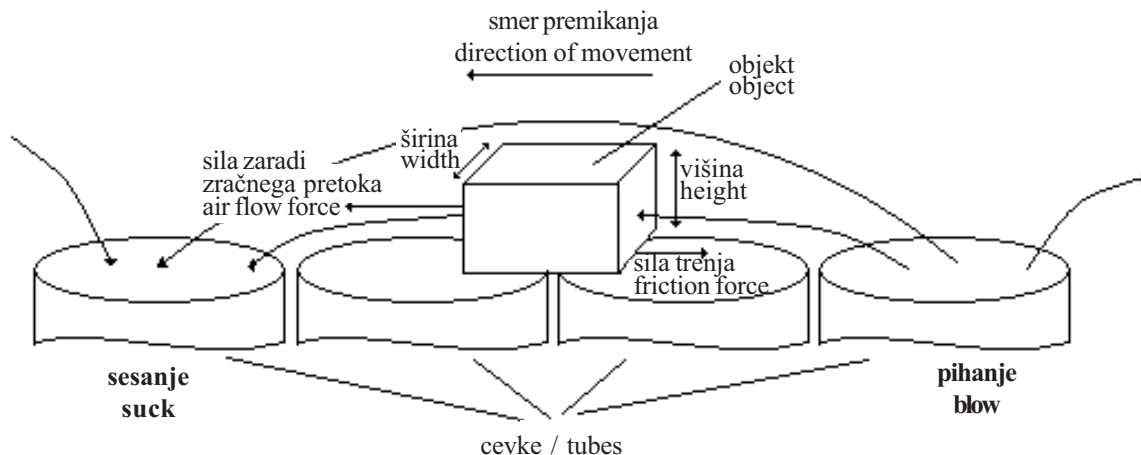

Sl. 4. Premik predmeta zaradi zračnega toka
 Fig. 4. Movement of the object in the airflow

skozi katero se zrak sesa, in cevko, skozi katero zrak piha, povzroči zračni tok v smeri od pihajoče cevke k sesajoči cevki. Ta zračni tok povzroči silo v smeri od pihajoče cevke proti sesajoči cevki. Če je sila zračnega toka večja od trenja med predmetom in površino naprave, potem se predmet premika v smeri zračnega toka. Če je predmet pretežak, ali če je sila trenja prevelika, tedaj uporabimo podobno tehniko za premikanje. Slednja tehnika je podobna prej opisani, le da v tem primeru tudi cevke pod predmetom pihajo zrak in s tem zmanjšajo trenje.

Razklenjena strategija krmiljenja, kakor tudi navidezno zančna in zančna strategija vodenja za premikanje predmetov na NPAP sta postopka krmiljenja po korakih. To pomeni, da so večji premiki togega predmeta izvedeni kot zaporedje manjših premikov togega predmeta. razklenjeno krmiljenje predmeta lahko obravnavamo navidezno ustaljeno. Z ustaljenim stanjem potencialnega polja pritiska sta

pressure between a sucking and a blowing tube causes the air to flow from the blowing tube to the sucking tube. The airflow delivers a force in a direction from the blowing tube to the sucking tube. If the airflow force is higher than the friction force between the surface and the object, the object moves in the direction of the airflow. If the object is too heavy or if the friction force is too high then another similar technique is used. This technique works in the same way as the previously described basic technique, except that tubes that are covered with the object have to be set to blow in order that the friction is decreased.

The open-loop control strategy, as well as the quasi-closed and closed-loop control strategies are step-by-step control approaches for the movement of rigid objects on the PASD. This means that the gross motion of a rigid object is achieved in a sequence of steps that represent the fine motion of a rigid object. The open-loop motion of the object is considered as

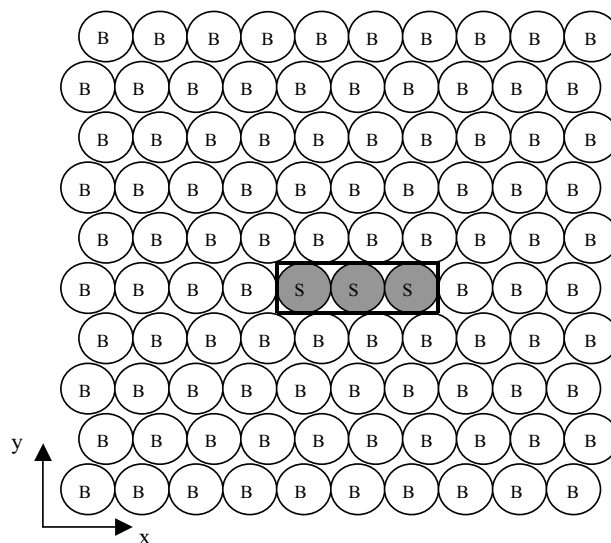

Sl. 5. Potencialno polje tlaka za predmet v vodoravni usmeritvi
 Fig. 5. Pressure potential field for an object in the horizontal orientation

enolično določena lega in usmeritev predmeta na NPAP. Primer potencialnega polja tlaka in z njim določene lege predmeta v vodoravni usmeritvi je prikazan na sliki 5.

Na sliki 5 je lega predmeta na NPAP prikazana s pravokotnikom, izrisanim s polno črto in s sivo barvo cevke, ki označuje cevke, pokrite s predmetom. Cevke s črko B pihajo zrak in imajo tlak višji od atmosferskega tlaka, medtem ko cevke s črko S sesajo zrak in imajo tlak nižji od atmosferskega tlaka. Predmet na sliki 5 je v ustaljenem stanju, določenem s prikazanim potencialnim poljem tlaka.

Vsak korak razklenjeno krmiljenje je posledica spremembe stanja potencialnega polja pritiska na NPAP. Ob spremembi potencialnega polja tlaka cevke, ki sesajo zrak, niso več pokrite s togim predmetom. Zato se vzpostavi zračni tok prek togega predmeta (sl. 4), tako da se predmet premakne, kakor je opisano v prvem odstavku podpoglavja 2.1. Premik togega predmeta je končan, ko ta ponovno pokrije cevke, ki sesajo zrak in se ponovno vzpostavi ustaljeno polje tlaka.

Predmete na NPAP lahko premikamo v različnih usmeritvah. Dve najbolj zanimivi usmeritvi: vodoravna in navpična usmeritev sta predstavljeni na sliki 6.

Iz vsakodnevnih izkušenj s predmeti na vodoravnih površinah kakor je miza, je znano, da so predmeti v vodoravni smeri stabilni, medtem ko so v navpični smeri labilno stabilni. Večja ko je višina predmeta v navpični smeri (razdalja med masnim središčem predmeta in vodoravno površino) v primerjavi z dolžino in širino predmeta, bolj labilna je stabilnost predmeta.

Stabilnost predmetov na NPAP je povečana v primerjavi s stabilnostjo istih predmetov na mizi. Povečano stabilnost predmetov na NPAP bomo prikazali na primeru predmeta v navpični smeri, ki na NPAP ni le labilno stabilen, temveč je stabilen.

quasi-stationary. With a stationary pressure potential field the position and the orientation of a rigid object on a PASD are uniformly defined. An example of the pressure potential field for a rigid object in a horizontal orientation is shown in Figure 5.

The position of the object on the PASD in figure 5 shows a rectangular plotted with a thick, solid line and gray-colored tubes covered by the object. The tubes with the letter B (blow) represent pressures higher than atmospheric pressure and the tubes with the letter S (suck) represent pressures lower than atmospheric pressure. The object in Figure 5 is in the stationary state determined by the pressure potential field.

Each step of the open-loop motion is the result of a change in the pressure potential field on the PASD. With a change of the pressure potential field the sucking tubes are not covered by the rigid object anymore. Therefore, an airflow is established across the rigid object (see Figure 4) so that the rigid object is moved in the way described in the first paragraph of subsection 2.1. The fine motion of a step is finished when the rigid object covers the sucking tubes again and a stationary pressure potential field is re-established.

Objects on the PASD can be moved in different orientations. The two most interesting orientations, horizontal and vertical, are represented in Figure 6.

From everyday experience of an object on a flat, horizontal surface, for example, a table, we know that objects in a horizontal orientation are stable, while objects in a vertical orientation are labile stable. The greater the height of the object in the vertical orientation (the distance between the center of mass and the flat horizontal surface) in comparison with its length and its width the more labile is the stability of the object.

It will be shown for the case of an object in the vertical orientation that the stability of the object on the PASD is increased in comparison to the stability of the same object on the table: i.e. the object on the PASD in the vertical orientation is not labile stable but stable.

(x^K, y^K, z^K) – lastni koordinatni sistem objekta / eigenvalue coordinate system of the object
 (x^R, y^R, z^R) – referenčni koordinatni sistem objekta / reference coordinate system of the object

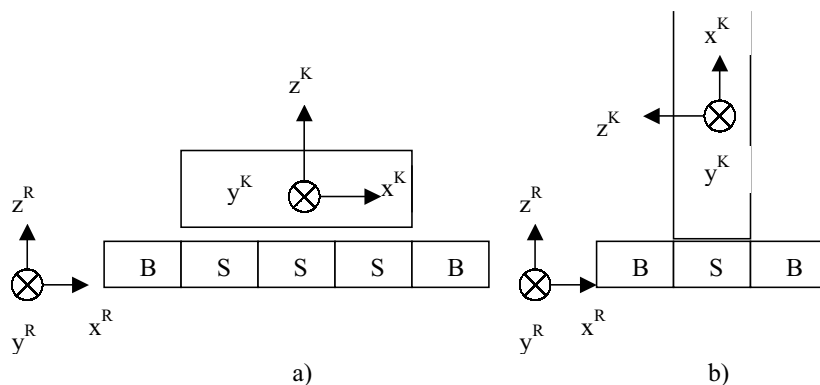

Sl. 6. a) Vodoravna in b) navpična usmeritev predmeta
 Fig. 6. a) Horizontal and b) vertical object orientation

Za izvedbo analize stabilnosti predmeta v navpični smeri na NPAP predpostavimo, da so cevke, iz katerih je zgrajena NPAP v smeri x in y urejene v ravne vrstice in stolpce. Gibanje predmeta na NPAP v navpični smeri (sl. 7) je naravno omejeno v negativni z^R smeri. Dodatno k naravni omejitvi gibanja bomo za izvedbo analize stabilnosti predpostavili, da ne obstajajo druga translacijska ali rotacijska gibanja predmeta razen vrtenja okoli osi y^R z osjo vrtenja v desnem spodnjem vogalu predmeta, kar je prikazano na sliki 7.

Gibanje predmeta je v takšnih razmerah definirano s sistemom enačb spremenljivk stanj:

$$\begin{bmatrix} \dot{\phi}_y \\ \ddot{\phi}_y \end{bmatrix} = \begin{bmatrix} 0 & 1 \\ 0 & 0 \end{bmatrix} \cdot \begin{bmatrix} \phi_y \\ \dot{\phi}_y \end{bmatrix} + \begin{bmatrix} 0 \\ \frac{1}{J_y^R} \end{bmatrix} \cdot \sum_i T_{yi} \quad (1)$$

kjer so: ϕ_y kot vrtenja okoli osi y^R , $\sum T_{yi}$ je vsota vseh vrtilnih momentov, ki delujejo na predmet, in J_y^R je vztrajnost predmeta okoli osi y^R referenčnega koordinatnega sistema. J_y^R je definirana po Steinerjevem pravilu in je vedno pozitivna.

$$J_y^R = m \cdot r^2 + J_y^K \quad (2)$$

m je masa predmeta, r je razdalja med osjo vrtenja in masnim središčem predmeta, J_y^K pa je vztrajnost predmeta okoli osi y^K .

Ravnotežna točka sistema je definirana z enačbo:

$$\begin{bmatrix} \dot{\phi}_y \\ \ddot{\phi}_y \end{bmatrix} = 0 \quad (3)$$

Pogoj (4) je določen z enačbama (1) in (3)

$$\frac{1}{J_y^R} \sum_i T_{yi} = 0 \Rightarrow \sum_i T_{yi} = 0 ; J_y^R > 0 \quad (4)$$

in mora biti izpolnjen, ko je sistem v ravnotežni točki.

V potrditev, da je predmet na sliki 7 v ravnotežni točki, je raziskan pogoj (4) za stanje s slike 7.

Predpostavimo enakomerno porazdelitev reakcijske sile in homogen material predmeta, vsota vrtilnih momentov $\sum T_{yi}$ je tedaj:

$$\sum_i T_{yi} = -T_g - T_s + T_t = -ds \cdot F_g - ds \cdot F_s + 2 \cdot ds \cdot F_t = -ds \cdot (F_g + F_s) + 2 \cdot ds \cdot \frac{1}{2} \cdot (F_g + F_s) = 0 \quad (5)$$

T_g je vrtilni moment okoli osi y^R , ki ga povzroča gravitacijska sila $F_g = m \cdot g$, delujoča na predmet. T_s je vrtilni moment okoli osi y^R , ki ga povzroča sila F_s delujoča na predmet, le ta pa se pojavi zaradi sesalnega učinka cevk, ki so prekrite s predmetom. Predpostavljamo, da deluje sila F_s v središču cevk, označenih s črko S na sliki 7. In T_t je vrtilni moment okoli osi y^R , ki ga povzročajo enakomerno porazdeljene površinske reakcijske sile F_t , delujoče na predmet, ds je polmer cevke.

For the stability analysis we have assumed that the tubes of the PASD in the x and y directions are arranged in straight rows and columns. The motion of the object on the PASD in the vertical direction (Fig. 7) is naturally constrained in the negative z^R direction. In addition to this natural constraint we will consider, for the purpose of this stability analysis, that no translational or rotational motion of the rigid object appears except for rotation around the y^R axis with the axis of rotation in the right-hand corner of the object as represented in Fig. 7.

The motion of the object under such a condition is defined by the system of state space equations:

where ϕ_y is the angle of rotation around the y^R axis, $\sum T_{yi}$ is the sum of all the torques that are acting on the object, and J_y^R is the inertia of the object around the y^R axis of the reference coordinate system. J_y^R is defined by Steiner's rule and is always positive.

m is the mass of the object, r is the distance between the axis of rotation and the object's center of mass, and J_y^K is the object's inertia around the y^K axis.

The equilibrium point of the system is defined by equation:

The condition (4) is determined from equations (1) and (3) and must be satisfied

if the system is at the equilibrium point.

To verify that the object in Figure 7 is at the equilibrium point the condition (4) is examined for the situation from Figure 7.

Assuming a uniform reactive force distribution and a homogeneous material for the object the sum of the torque $\sum T_{yi}$ is:

T_g is the torque around the y^R axis produced by gravitational force $F_g = m \cdot g$ on the object. T_s is the torque around the y^R axis produced by the force F_s on the object, which appears as a result of the sucking action of the tubes where the tubes are covered by the object. It is assumed that force F_s is acting in the middle of the tube denoted by S in Figure 7. And T_t is the torque around the y^R axis produced by the uniformly distributed surface reactive force F_t on the object. ds is equal to half of the tube diameter.

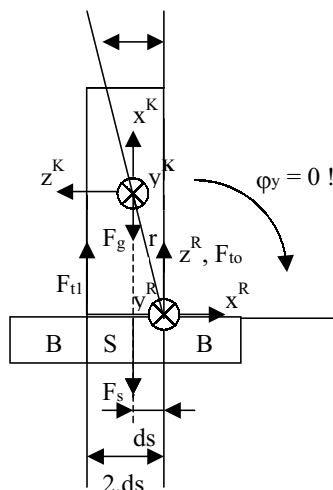

Sl. 7. Predmet v navpični usmeritvi
Fig. 7. Object in the vertical orientation

Ker je pogoj (4) izpolnjen, je predmet na sliki 7 v ravnotežni legi. Za analizo stabilnosti ravnotežne točke smo uporabili metodo Ljapunova. Če je ravnotežna točka stabilna, tedaj se bo predmet vrnil v ravnotežno točko tudi, če ga zavrtimo v levo, izmaknjeno iz ravnotežne lege. Kinetično energijo rotirajočega predmeta smo izbrali kot kandidata za Ljapunovovo funkcijo (6) sistema.

$$V = W_{krot} = \frac{J_y^R \cdot \dot{\varphi}_y^2}{2} \geq 0 \quad (6)$$

Izbrana funkcija Ljapunova je pozitivno definitna, ker je vztrajnost predmeta J_y^R vedno pozitivna (2). Da bo sistem stabilen, mora biti odvod Ljapunovove funkcije \dot{V} negativno semidefiniten.

$$\dot{V} = \dot{\varphi}_y \cdot J_y^R \cdot \ddot{\varphi}_y = \dot{\varphi}_y \cdot \sum_i T_{yi} \leq 0 \quad (7)$$

Oglejmo si stanje na sliki 8. Na sliki 8 je predmet zasukan za neki kot φ_y iz ravnotežne lege in se vrti okoli osi y^R s pozitivno hitrostjo $\dot{\varphi}_y > 0$.

Za izvedbo analize stabilnosti moramo torej ovrednotiti vsoto vrtilnih momentov $\sum_i T_{yi}$, ki skupaj s hitrostjo $\dot{\varphi}_y$ določa odvod funkcije Ljapunova. Če je $\sum_i T_{yi} \leq 0$, tedaj je navpična smer predmeta stabilna. Vsota vrtilnih momentov $\sum_i T_{yi}$ je za območje kota $0 \leq \varphi_y < 90^\circ$ enaka:

$$0 \leq \varphi_y < \alpha \quad \Rightarrow \sum_i T_{yi} = -T_g - T_s - \sum_j T_{Bj} \leq 0 \quad (8)$$

$$\alpha \leq \varphi_y < 90^\circ \quad \Rightarrow \sum_i T_{yi} = +T_g - T_s - \sum_j T_{Bj}$$

kjer je, enako kakor prej, T_g vrtilni moment okoli osi y^R , ki ga povzroča gravitacijska sila $F_g = m \cdot g$, delujoča na predmet, T_s je vrtilni moment okoli osi y^R , ki ga povzroča sila F_s , delujoča na predmet, le ta pa se pojavi zaradi sesalnega učinka cevok, ki so prekrte s predmetom. Vsoto vrtilnih momentov $\sum_j T_{Bj}$ okoli osi y^R ustvarjajo cevke s pihanjem zraka na predmet, ds je enak polmeru cevke.

Therefore, the object in Figure 7 is at the equilibrium point. To analyze the stability of the equilibrium point we used the Lyapunov method. If the equilibrium point is stable the object should return to the equilibrium point from a situation where the object is rotated out of the equilibrium point. The kinetic energy of the rotated object is chosen as a candidate Lyapunov function (6) of the system.

The chosen Lyapunov function is positive definite because the term J_y^R is always positive (2). In order for the system to be stable the derivative of the Lyapunov function \dot{V} must be negative semi-definite.

Now consider the situation in Figure 8. The object in Figure 8 is rotated out of the equilibrium point by an angle φ_y and rotates around the axis y^R with positive speed $\dot{\varphi}_y > 0$.

Therefore, for the stability analysis the sum of the torque $\sum_i T_{yi}$ has to be evaluated. If $\sum_i T_{yi} \leq 0$ then the object is stable. The sum of torque $\sum_i T_{yi}$ for the range of $0 \leq \varphi_y < 90^\circ$ is:

where, as before, the torque T_g around the y^R axis is produced by gravitational force $F_g = m \cdot g$ on the object, the torque T_s around the y^R axis is produced by the force F_s due to the sucking action of the tubes on the object and the sum of the torque $\sum_j T_{Bj}$ around the y^R axis is produced by the blowing action of the tubes on the object. ds is equal to half of the tube diameter.

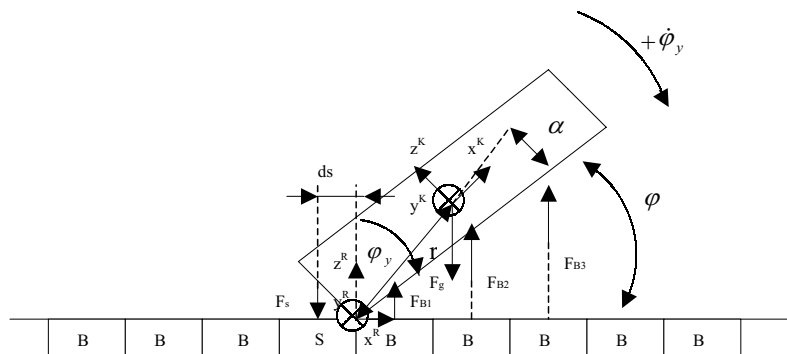

Sl. 8. Predmet, zasukan iz ravnotežne lege
Fig. 8. The object rotated out of the equilibrium point

Stabilnost predmeta v območju $0 \leq \varphi_y < \alpha$ pomeni področje labilne stabilnosti predmeta v navpični usmeritvi. To območje je enako območju labilne stabilnosti predmeta v navpični smeri na mizi. Na NPAP pa se zaradi sesanja in pihanja zraka iz cevk območje stabilnosti navpične smeri razširi tudi na območje $\alpha \leq \varphi_y < 90^\circ$.

Vrtilni moment, ki ga povzroča gravitacijska sila, je:

$$T_g = r \cdot \cos(\alpha + 90^\circ - \varphi_y) \cdot F_g; \quad F_g = m \cdot g \quad (9)$$

Vrtilni navor, ki ga povzroča sila F_s , zaradi sesalnega učinka cevk v vrsti, ki so prekrile s predmetom, je:

$$T_s = -ds \cdot F_s \quad (10)$$

Silo F_s lahko določimo iz:

$$F_s = -(p_{air} \cdot A_{OBT} - (p_{air} + p_s) \cdot A_{OBB}) \cdot \cos \varphi_y \quad (11)$$

kjer je A_{OBB} površina spodnje strani predmeta, p_{air} je atmosferski tlak. Predpostavljamo, da sta spodnja in zgornja stran predmeta (A_{OBB}, A_{OBT}) enaki in sta A_{OB} . Prav tako predpostavljamo, da je vrednost vakuumna nespremenljiva na spodnji strani predmeta. Vrednost $p_s < 0$ v primeru sesanja cevk. Zato lahko enačbo (11) prepišemo:

$$F_s = p_s \cdot A_{OB} \cdot \cos \varphi_y \quad (12)$$

Kakor prej, je predpostavljeno, da deluje sila F_s v središču cevk, ki sesajo. Zato je ds razdalja med središčem vrstice cevk, ki sesajo in osjo y^R . F_{Bj} je sila, ki nastane zaradi pihanja zraka skozi cevke v j-ti vrstici pod desno stranjo predmeta. Vrtilni navor T_{Bj} okoli osi y^R povzroča sila F_{Bj} .

$$T_{Bj} = -ds \cdot F_{Bj}; \quad F_{Bj} = p_B \cdot A_{Orij} \cdot \cos \varphi = p_B \cdot A_{Orij} \cdot \cos(90^\circ - \varphi_y) \quad (13)$$

Vrednost $p_B > 0$ v primeru pihanja cevk in A_{Orij} je j-ti del površine desne strani predmeta,

The stability of the object in the range $0 \leq \varphi_y < \alpha$ represents the labile stability range of the object as would be the case for the same object on a table. On the PASD the torque due to the sucking and blowing actions of the tubes on the object results in an increase in the stability range into the region $\alpha \leq \varphi_y < 90^\circ$.

The torque produced by gravitational force is:

The torque produced by the force F_s due to the sucking action of the tubes in a row that is beneath the bottom side of the object is:

The force F_s can be calculated as:

where A_{OBB} is the surface of the bottom side of the object and p_{air} is the atmospheric pressure. It is assumed that the bottom and the top (A_{OBB}, A_{OBT}) surfaces of the object are the same and are equal to A_{OB} . It is also assumed that the vacuum value p_s is constant on the bottom surface of the object. The value is $p_s < 0$ for the sucking action. So, the equation (11) could be rewritten:

As before, it is assumed that force F_s is acting in the middle of the row of sucking tubes. Therefore, ds is the distance between the middle of the row of sucking tubes and the axis y^R . F_{Bj} is the force produced by the blowing action of the tubes in the j-th row that is beneath the right-hand side of the object. The torque T_{Bj} around the y^R axis is produced by the force F_{Bj} .

The value $p_B > 0$ for the blowing action and A_{Orij} is the j-th part of the surface of the right-hand

ki bi pokrival cevke, če bi predmet ležal vodoravno. Predpostavljamo, da deluje sila F_{Bj} v središču cevk. Zato je razdalja med osjo y^R središčem j -te cevk enaka $(j-1/2) \cdot d_t$, kjer je d_t premer cevk NPAP.

Vsota vrtilnih momentov, ki delujejo na predmet, je tako:

$$\sum_i T_{yi} = T_g - T_s - \sum_j T_{Bj} = m \cdot g \cdot r \cdot \cos(90^\circ + \alpha - \varphi_y) - \frac{1}{2} \cdot d_t \cdot p_s \cdot A_{OB} \cdot \cos \varphi_y - \sum_j (j - \frac{1}{2}) \cdot d_t \cdot p_B \cdot A_{OBj} \cdot \cos(90^\circ - \varphi_y) \quad (14)$$

V območju $\alpha \leq \varphi_y < 90^\circ$ so vse tri trigonometrične funkcije: $\cos(90^\circ + \alpha - \varphi_y)$, $\cos(\varphi_y)$ in $\cos(90^\circ - \varphi_y)$ iz enačbe (14) pozitivne. Zato vrtilni moment, ki nastaja zaradi sesanja in pihanja cevk nasprotuje vrtilnemu momentu, ki ga povzroča sila teže F_g . Z dovolj visoko nastavitvijo vrednosti tlaka sesanja in pihanja NPAP lahko zagotovimo:

$$\sum_i T_{yi} \leq 0 \quad (15)$$

za vse $\alpha \leq \varphi_y < 90^\circ$. In stabilnost navpične smeri predmeta je zagotovljena.

Če se zavrti predmet iz ravnotežne lege z usmeritvijo proti desni $\dot{\varphi}_y > 0$, kakor je prikazano na sliki 8, tedaj je odvod Ljapunove funkcije $\dot{V} = \dot{\varphi}_y \cdot \sum_i T_{yi} \leq 0$, ker je $\dot{\varphi}_y > 0$ in $\sum_i T_{yi} \leq 0$. Z enako metodo Ljapunova in podobnimi enačbami, ki so prej opisane, je mogoče dokazati tudi stabilnost predmeta, ki ga zavrtimo iz ravnotežne lege v levo. To pomeni, da je navpična usmeritev predmeta stabilna.

Potencialno polje tlaka je lahko neskončno visoko in nespremenljivo (laminarni zračni tok) v teoriji, ne pa tudi v praksi. Zato velja ta analiza stabilnosti le za predmete v navpični usmeritvi, katerih višina ne presega višine laminarnega zračnega toka, ki ga ustvarja potencialno polje tlaka NPAP. Zaradi dejanske ureditve cevk NPAP (kjer cevke niso urejene v ravne vrstice po smeri y) je potreben za dosego enake stabilnosti nekoliko višji tlak. Zaradi povečane stabilnosti usmeritve predmeta je med gibanjem predmeta zagotovljena robustnost na spremembe usmeritve predmeta med razklenjenim krmiljenjem.

3 SKLEP

Ta prispevek prikazuje načrtovanje prototipa naprave s pnevmatično aktivno površino, njene potencialne uporabe in osnove gibanja objekta v zračnem toku, ki ga povzroči aktivna površina. Naslednja pomembna razlaga, ki je opisana v prispevku, je analiza stabilnosti po Ljapunovu za tog objekt v navpični usmeritvi, ki prikazuje povečano stabilnost objekta na NPAP zaradi zračnega toka aktivne površine.

side of the object covering the tubes of the PASD if the object would be in the horizontal orientation. It is assumed, again, that the F_{Bj} force is acting in the middle of the tubes. Therefore, the distance between the y^R axis and the middle of the j -th tube is $(j-1/2) \cdot d_t$, where d_t is the diameter of the tube of the PASD.

The sum of the torque acting on the object is:

In the range $\alpha \leq \varphi_y < 90^\circ$ all three trigonometric cosine functions: $\cos(90^\circ + \alpha - \varphi_y)$, $\cos(\varphi_y)$ and $\cos(90^\circ - \varphi_y)$ from equation (14) are positive. Therefore, the torque due to the sucking or blowing actions counteracts the gravity torque produced by the gravity force F_g . With a high enough level of adjustment of the blowing and sucking pressure of the PASD we can achieve:

for all $\alpha \leq \varphi_y < 90^\circ$. And the stability of the vertical object's orientation is ensured.

If the object comes out of the equilibrium region with rotation to the right $\dot{\varphi}_y > 0$ as shown in Figure 8 then the derivative of the Lyapunov function $\dot{V} = \dot{\varphi}_y \cdot \sum_i T_{yi} \leq 0$ since $\dot{\varphi}_y > 0$ and $\sum_i T_{yi} \leq 0$. The same Lyapunov method, with practically the same equation development as previously described, can be used to prove stability if the object comes out of the equilibrium point to the left. It means that the considered equilibrium point (vertical orientation) is stable.

The pressure potential field could be infinitely high and constant (laminar air-flow) in theory, but this is not possible in practice. Therefore, this stability analysis has practical value only for objects in the vertical orientation with a height that does not exceed the height of the laminar air-flow produced by the pressure potential field of the PASD. The actual arrangement of tubes for the PASD (the tubes are not in straight columns in the y direction) due to non-idealities means we need a slightly higher pressure to achieve the same stability. With the increased stability of the object orientation during step-by-step motion the robustness in terms of object orientation changes during the open-loop control is ensured.

3 CONCLUSION

This paper presents a prototype design of a PASD, its potential applications, and the basics of how an object is moved in the airflow caused by an active surface. The next important explanation is a Lyapunov-based stability analysis of a rigid object in the vertical orientation, which showed increased stability of the objects on the PASD due to the airflow of the active surface.

Zahvala

Projekt razvoja prototipne naprave NPAP je bil med drugim financiran tudi iz programa Fulbright-ovih štipendij in je bil izveden v Laboratorijih centra za avtomatizacijo tehnologij, New York center naprednih tehnologij, Rensselaer Polytechnic Institute. Avtorji prispevka bi se radi posebej zahvalili vsemu osebju, ki je kakor koli prispevalo razvoju NPAP v Center for Automation Technology, posebej prof. Hary-ju Stephanou in Ben-u Potsaid-u.

Acknowledgment

This project is also funded under the Fulbright Scholar Program and was developed in the laboratories of the Center for Automation Technologies, New York State Center for Advanced Technology, Rensselaer Polytechnic Institute. The authors of the paper would like to thank all involved personnel in the Center for Automation Technologies, especially to Ben Potsaid and Harry Stephanou.

4 LITERATURA

4 REFERENCES

- [1] Böhringer, K.-F., B.R. Donald, N.C. MacDonald (1999) Programmable force fields for distributed manipulation, with applications to MEMS actuator arrays and vibratory parts feeders, *The International Journal of Robotics Research*, vol. 18, No. 2, 168-200.
- [2] Böhringer, K.-F., K. Goldberg, M. Cohn, R. Howe (1998) Parallel microassembly with electrostatic force fields, *Proceedings of the 1998 IEEE*, International Conference on Robotics & Automation, Lueven, Belgium, 1204-1211.
- [3] Kavraki, L. E. (1997) Part orientation with programmable vector fields: two stable equilibria for most parts, *Proceedings of the 1997 IEEE*, International Conference on Robotics and Automation, Albuquerque, New Mexico, 2446-2451.
- [4] Luntz, J. E., W. Messner, H. Choset (1997) Parcel manipulation and dynamics with a distributed actuator array: the virtual vehicle, *Proceedings of the 1997 IEEE*, International Conference on Robotics and Automation, Albuquerque, New Mexico, 2446-2451.
- [5] Akiyama, T., D. Collard, H. Fujita (1997) Scratch drive actuator with mechanical links for self-assembly of three-dimensional MEMS, *Journal of Microelectromechanical systems*, VOL. 6, No. 1, 10-17.
- [6] Konishi, S., H. Fujita (1994) A conveyance system using air flow based on the concept of distributed micro motion system, *Journal of Microelectromechanical systems*, VOL. 3, No. 2, 54-58.
- [7] Wenheng, L., P. Will (1995) Parts manipulation on an intelligent motion surface, *Proceeding of IROS'95*, 399-404.
- [8] Pister, K. S. J., R. Fearing, R. Howe (1990) A planar air levitated electrostatic actuator system, *Proceedings IEEE Workshop on MEMS*, Napa Valley, California, 67-71.
- [9] Fujita, H. (1993) Group work of microactuators, *International Advanced Robot Program Workshop on Micromachined Technologies and Systems*, Tokyo, Japan, 24-31.
- [10] Storment, C. W., D.A. Borkholder, V. Westerlind, J.W. Suh, N.I. Maluf, G.T.A. Kovacs (1994) Flexible, dry-released process for aluminum electrostatic actuators, *Journals of Microelectromechanical Systems*, 3(3), 90-96.
- [11] Liu, C., Tsao, T., Will, P., Tai, Y., Liu, W.: A micro-machined magnetic actuator array for micro-robotics assembly systems, *Transducers-Digest Int. Conf. On Solid-State Sensors and Actuators*, Stockholm, Sweden, 34-38.
- [12] Vikramaditya, B., B.J. Nelson (1999) Visually servoed micropositioning for robotics micromanipulation, *Microcomputer Application*, Vol. 18, No. 1, 64-72.

Naslovi avtorjev: dr. Suzana Uran
prof.dr. Riko Šafarič
Fakulteta za elektrotehniko,
računalništvo in informatiko
Univerza v Mariboru
Smetanova 17
2000 Maribor
suzana.uran@uni-mb.si
riko.safaric@uni-mb.si

dr. Tobias Winther
Center for Automation
Technologies
Rensselaer Polytechnic Institute
110 8th Street, CII 8015, Troy
New York 12180-3590, USA
winther@cat.rpi.edu

Authors' Addresses: Dr. Suzana Uran
Prof.Dr. Riko Šafarič
Faculty of Electrical Eng. and
Computer Sciences
University of Maribor
Smetanova 17
2000 Maribor, Slovenia
suzana.uran@uni-mb.si
riko.safaric@uni-mb.si

Dr. Tobias Winther
Center for Automation
Technologies
Rensselaer Polytechnic Institute
110 8th Street, CII 8015, Troy
New York 12180-3590, USA
winther@cat.rpi.edu

Prejeto: 8.5.2001
Received:

Sprejeto: 23.5.2002
Accepted: