

Analiza visokotlačnega in nizekotlačnega vračanja izpušnih plinov v tlačno polnjenem dizelskem motorju

An Analysis of the Application of High- and Low-Pressure Exhaust-Gas Recirculation to a Turbocharged Diesel Engine

Aleš Hribernik - Gorazd Bombek

Vračanje izpušnih plinov je učinkovita metoda za zmanjšanje emisije dušikovih oksidov (NO_x). Dva različna postopka vračanja izpušnih plinov se lahko uporabita za tlačno polnjene dizelske motorje. Pri nizkotlačnem postopku vodimo del izpušnih plinov, ki iztekajo iz turbine, na polnilno stran motorja, kjer se pomešajo s svežim zrakom. Alternativna pot je visokotlačni postopek. Pri tem postopku odvezemo del izpušnih plinov že pred turbino in jih pri nadtlaku tlačimo v polnilni zbiralnik za kompresorjem. Z enorazsežno metodo smo simulirali tokovne in termodinamične procese v štirivaljnem motorju z vračanjem izpušnih plinov po obeh postopkih. Raziskali smo možnost doseganja zelene stopnje vračanja z obema postopkoma in njun vpliv na obratovalne karakteristike motorja in turbokompresorja. Rezultati so prikazani v prispjevku.

© 2004 Strojniški vestnik. Vse pravice pridržane.

(Ključne besede: motor z notranjim zgorevanjem, recirkulacija izpušnih plinov, emisije NO_x, meritve, simuliranje)

Exhaust-gas recirculation (EGR) is an effective way of reducing NO_x emissions. Two different strategies can be applied when using EGR in a turbocharged diesel engine. The first one is known as low-pressure EGR, where a passage is provided enabling exhaust gasses from below the turbine to pass to the fresh-air side of the engine. Its alternative is high-pressure EGR. In this EGR configuration the exhaust gas is withdrawn from the exhaust manifold above the turbine and fed to the intake manifold below the compressor. The applications of both strategies to a four-cylinder diesel engine were studied by means of a one-dimensional simulation. The possible range of EGR applications for both concepts and their effects on the engine and turbocharger operations were examined and are discussed in this paper.

© 2004 Journal of Mechanical Engineering. All rights reserved.

(Keywords: internal combustion engines, exhaust gas recirculation, NO_x emissions, measurements, simulations)

0 UVOD

Vračanje izpušnih plinov je uveljavljen postopek za zmanjšanje emisij dušikovih oksidov NO_x v motorjih s prisilnim vžigom in se vse bolj uveljavlja tudi v manjših dizelskih motorjih. Z vračanjem izpušnih plinov zmanjšamo NO_x pri vseh obratovalnih pogojih motorja. Še posebej pomembno pa je zmanjšanje NO_x pri visokih obremenitvah motorja, saj v teh razmerah nastaja največ NO_x [1].

Med razlogi za zmanjšanje NO_x zaradi vračanja izpušnih plinov se najpogosteje omenja znižanje najvišjih temperatur v valju motorja zaradi zmanjšanja koncentracije kisika in povečanja toplotne kapacitete zmesi v valju. Ker je visoka temperatura v valju najpomembnejši dejavnik pri nastanku NO_x, je uporaba vračanja izpušnih plinov izredno učinkovit postopek za njegovo zmanjševanje [2]. Z raziskavami

0 INTRODUCTION

Exhaust-gas recirculation (EGR) is a well-established approach for NO_x-emission reduction in spark-ignition engines, and is now used extensively in small diesel engines. EGR is effective for reducing NO_x under all load conditions. High-load NO_x reduction in diesel engines is especially important because most of the NO_x is produced under high loads [1].

Several explanations have been proposed for the reduction in NO_x emissions using EGR. These explanations focus on EGR's reduction of the peak cylinder temperature due to the reduced oxygen concentration and the increased heat capacity of in-cylinder gases. EGR is an effective means of controlling NO_x formation, because the peak cylinder temperature is the most influential variable affecting NO_x pro-

je ugotovljeno, da je mogoče zmanjšati koncentracijo NOx v izpušnih plinih za 30 do 75 % pri uporabi 5 do 25 % stopnje vračanja izpušnih plinov ([1] in [3]).

Žal se pojavljajo pri uporabi vračanja izpušnih plinov tudi neželeni stranski učinki. Poveča se obraba motornih delov, potreben je višji polnilni tlak in povečajo se emisije neizgorelih ogljikovodikov (HC) in saj. Povečana obraba je predvsem posledica abrazije, ki jo povzročajo delčki (saje) v polnilnem zraku in žveplene kisline v recirkuliranih izpušnih plinih, in povzroča razgradnjo mazalnega olja [1]. Povečan tlak polnjenja je potreben zato, ker izpušni plini nadomestijo del zraka v polnilnem zbiralniku in je potrebna večja skupna masa polnjenja valjev motorja, da lahko zgore enaka količina goriva in ostane gostota moči motorja nespremenjena [1]. Povečanje emisije delčkov (saj) je opaziti predvsem pri velikih obremenitvah. Predpostavlja se, da je posledica znižanja temperature zgorevanja, kar zmanjša hitrost oksidacije saj [4].

Vračanje izpušnih plinov v tlačno polnjenem dizelskem motorju lahko izvedemo z dvema postopkoma. Tako imenovani nizkotlačni postopek prikazuje slika 1. Del izpušnih plinov, ki iztekajo iz turbine, vodimo na polnilno stran motorja in jih mešamo s svežim zrakom. Pozitivna tlačna razlika med izpušno in sesalno stranjo motorja omogoča preprosto vodenje s krmilnim ventilom in veliko stopnjo vračanja v širokem delovnem področju motorja. Potrebna je uporaba filtra za saje, da se izognemo obrabi kompresorskih lopatic in zamašitvi hladilnika polnilnega zraka [5]. Alternativa nizkotlačni je visokotlačno vračanje izpušnih plinov, ki izkorišča tlačne valove v izpušnem sistemu pred turbino.

duction [2]. Researchers observed 30 % to 75 % reductions in NOx when using 5 % to 25 % EGR rates ([1] and [3]).

Unfortunately, EGR also has undesirable side-effects, these include: increased engine wear, higher required boost pressure, and higher HC and particulate emissions. The increased engine wear is due to abrasion by the particulates present in the intake air, and from the sulphuric acid present in the recirculating exhaust gas, which tends to break-down the lubricating oil [1]. Higher boost pressures are required because the exhaust is replacing some of the oxygen in the intake manifold. The increased total mass must, therefore, be forced into the cylinder to burn the same quantity of fuel and retain the original power density [1]. The increase in particulate emissions occurs mainly under high loads, and is believed to be due to the reduced combustion temperatures resulting from reduced soot-oxidation rates [4].

Two different strategies can be applied to EGR in a turbocharged diesel engine. The first one is known as the low-pressure EGR concept (Fig. 1). A passage is provided for the exhaust gases from below the turbine to pass to the fresh-air side of the engine. The positive pressure difference across the appropriate EGR valve makes EGR possible over a wide range of engine operating conditions. Increased wear on the compressor blades, and charge air cooler contamination may occur, however, if no diesel particulate filter is used [5]. The alternative is high-pressure EGR, which makes use of the dynamic pressure above the turbine. In this EGR configuration (Fig. 2) the exhaust gas is withdrawn from the ex-

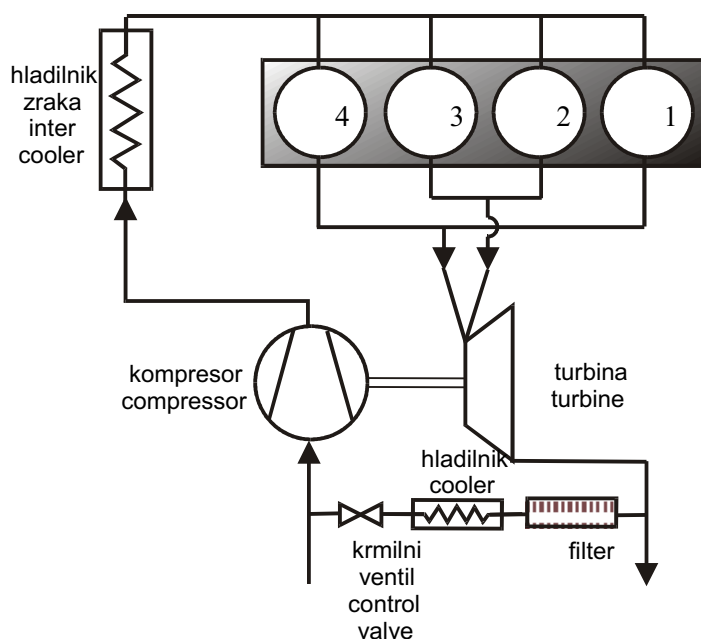

Sl. 1. Nizko-tlačni postopek vračanja
Fig. 1. Low-pressure EGR concept

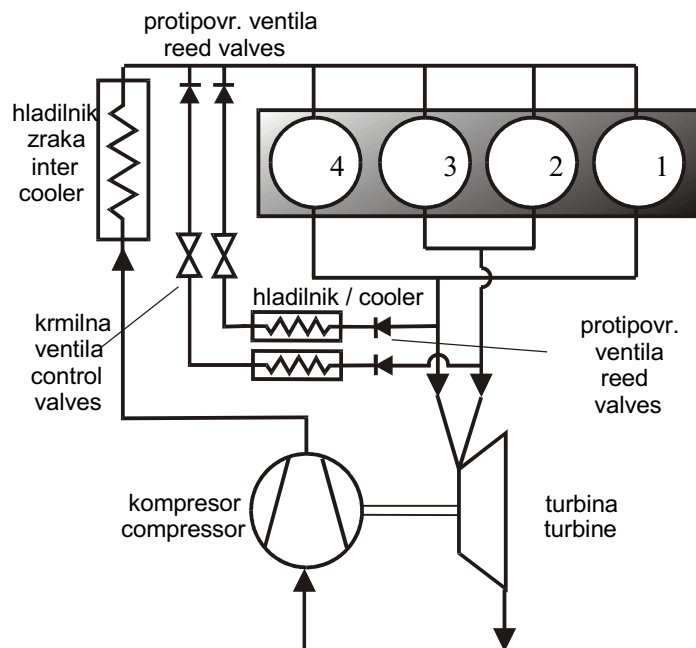

Sl. 2. Visoko-tlačni postopek vračanja
Fig. 2. High-pressure EGR concept

Postopek je prikazan na sliki 2. Del izpušnih plinov se že pred turbino odcepi in vteka v polnljni zbiralnik za kompresorjem. Vrnjeni izpušni plini zato ne potujejo skozi kompresor in hladilnik polnilnega zraka. S tem se izogemo problemom, značilnim za nizekotlačni postopek vračanja izpušnih plinov.

Raziskave in primerjava obeh postopkov vračanja na 6-valjnem tlačno polnjenem dizelskem so že bile opravljene, tako z eksperimentalnim postopkom [5] kakor tudi z uporabo simulacijskih metod [6]. Namen predstavljene študije pa je bil preučiti uporabo obeh postopkov na 4-valjnem motorju. Dela smo se lotili tako, da smo najprej z meritvami ugotavljali vpliv stopnje vračanja na znižanje NO_x in na spemembo preostalih emisijskih komponent v izpušnih plinih. S tem smo poskušali določiti najprimernejšo stopnjo vračanja izpušnih plinov za obravnavan motor. Nato pa smo z uporabo enorazsežne metode simulirali tokovne in termodinamične procese v štirivaljnem motorju z vračanjem izpušnih plinov po obeh postopkih. Raziskali smo možnost doseganja želene stopnje vračanja z obema postopkoma in vpliv vračanja na obratovalne karakteristike motorja in turbokompresorja.

1 RAZISKAVE VPLIVA STOPNJE VRAČANJA IZPUŠNIH PLINOV NA EMISIJO ŠKODLJIVIH KOMPONENT V IZPUŠNIH PLINIH

Raziskave smo izvedli s prototipnim motorjem TAM BF4L515. Osnovne karakteristike motorja so zbrane v preglednici 1. Uporabili smo nizekotlačni postopek vračanja (slika 1). Vrnjene izpušne pline smo najprej vodili skozi filter za saje. Nato smo jih ohladili v prenosniku toplote voda –

haust manifold above the turbine and fed to the intake manifold below the compressor. The recirculated exhaust gas, therefore, does not pass through the compressor and intercooler and the problems encountered using the low-pressure EGR strategy do not occur.

The application of both strategies for a six-cylinder engine have already been studied by means of both experiment [5] and simulation [6]. The purpose of this presented study was to examine the application of both concepts for a four-cylinder engine. First, the effect of EGR on NO_x reduction and emissions formation was studied using a set of measurements performed on the test engine, and the results were used to predict the optimal EGR rate. Then a one-dimensional simulation was used to simulate flow and thermodynamic processes within the four-cylinder engine with both EGR concepts applied in order to establish the possibility of achieving the optimum experimentally obtained EGR rate for each individual concept, and to study the effects of EGR on the engine and turbocharger operation.

1 INVESTIGATION OF THE INFLUENCE OF EGR RATE ON THE ENGINE EMISSIONS

Investigations were performed on the TAM BF4L515 diesel engine. The characteristics of this engine are summarised in Table 1. The low-pressure EGR concept (Fig. 1) was applied. A passage was provided for the exhaust gases from below the turbine to pass to the fresh-air side of the engine through

Preglednica 1. Podatki o testnem motorju

Table 1. Test engine specifications

Motor Engine	tlačno poljnjeni, 4-taktni dizelski z neposrednim vbrizgom goriva turbocharged, 4-stroke direct injected diesel engine
Dobava goriva Fueling	tlačilka BOSCH BOSCH in-line pump
Število valjev Number of cylinders	4
Premer x gib bata Bore x stroke	125 mm x 145 mm
Gibna prostornina Total displacement	7117 cm ³
Tlačno razmerje Compression ratio	15,8
Turbokompresor Turbocharger	HOLSET H1E8264AX/GA26*11

plin na temperaturo 25 °C in jih prek krmilnega ventila vodili v sesalno cev motorja. Stopnjo vračanja smo spreminjali z nastavitvijo krmilnega ventila in jo določili kot razmerje masnega toka vrnjenih izpušnih plinov in celotnega masnega pretoka skozi motor.

Meritve smo izvajali pri nespremenljivi vrtilni frekvenci in stalnem srednjem dejanskem tlaku motorja. Merili smo osnovne obratovalne parametre motorja, to so: vrtilna frekvenca motorja in turbokompresorja, vrtilni moment motorja, pretok svežega zraka, pretok vrnjenih izpušnih plinov, poraba goriva, tlak in temperatura polnilnega zraka in izpušnih plinov v značilnih točkah, temperatura glave in valjev motorja. Hkrati smo merili tudi koncentracijo plinskih komponent v izpušnih plinih. Koncentracijo NO_x smo izmerili s kemoluminescenčno metodo, koncentracijo neizgorelih ogljikovodikov HC s plamensko ionizacijskim detektorjem, stopnjo sajavosti z Boschevo metodo, koncentracijo CO z metodo absorpcije nerazsejane infrardeče svetlobe in koncentracijo O₂ z elektrolitsko metodo. Na sliki 3 je prikazana značilna sprememba koncentracije plinskih komponent v odvisnosti od povečevanja stopnje recirkulacije. Koncentracija NO_x se močno zmanjša že pri 8-odstotni stopnji vračanja in je pri 21-odstotni stopnji vračanja manjša za 65 odstotkov. Vračanje ne vpliva pomembno na povečanje koncentracije HC, pač pa vpliva predvsem na povečanje sajavosti in povečanje koncentracije CO; v obeh primerih za dobrih 300 odstotkov pri 21-odstotni stopnji vračanja. Ugotovimo lahko, da je za prikazan primer najprimernejša 14-odstotna stopnja vračanja, pri kateri je osnovna koncentracija NO_x več ko razpolovljena, medtem ko se sajavost in koncentracija CO niti ne podvojita.

2 RAČUNALNIŠKA SIMULACIJA TLAČNO POLNJENEGA MOTORJA

Uporabili smo enorazsežno metodo za simulacijo tokovnih in termodinamičnih postopkov v

a diesel particulate filter. The recirculated gas was externally cooled by water to gas heat exchanger, and the gas temperature was maintained at 25 °C. The EGR rate was defined as the ratio of the recirculated mass flow and the total mass flow through the engine, and it was controlled by the EGR valve.

Measurements were performed at a constant engine speed and a constant mean effective pressure. All the basic engine operational parameters, such as engine speed and turbocharger (rpm), engine torque, fresh-air flow rate, recirculated-gas flow rate, fuel consumption, pressures and temperatures at the intake and exhaust side of the engine, were measured. The exhaust-gas emissions were measured simultaneously. The NO_x concentration was measured by a chemiluminescence analyser; a flame ionisation detector was used for the unburned hydro-carbon measurement, particulates were monitored with the AVL 450 smoke meter, the carbon monoxide concentration was measured with a nondispersive infrared analyser, and a ZrO₂ electrolytic method was used for the oxygen concentration measurement. A typical effect of EGR on the exhaust-gas emissions of the investigated engine is shown in Fig. 3. NO_x was already drastically reduced with 8 % EGR. It was reduced by more than 65 % with 21 % EGR. Almost no EGR effect on the emissions of the unburned hydrocarbons (HCs) was observed. However, the emissions of carbon monoxide and particulates tripled with 21 % EGR. In this particular case it can be seen that 14 % EGR was the optimum, NO_x emissions were reduced by more than 50 %, while CO and particulate emissions were still satisfactory.

2 COMPUTER SIMULATION OF TURBOCHARGED ENGINE

A one-dimensional method was used to simulate the flow and thermodynamic processes

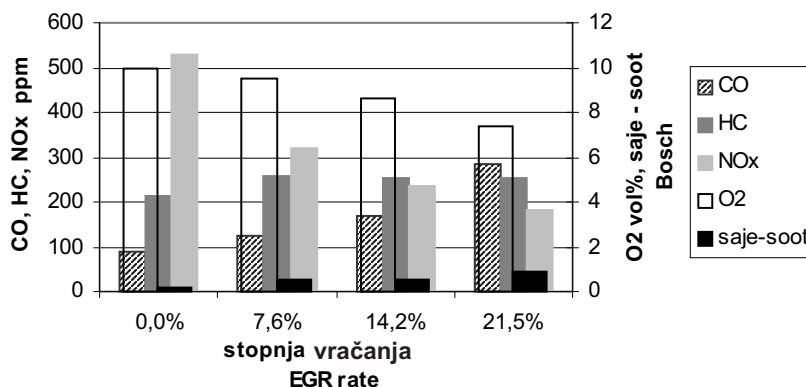

Sl. 3. Vpliv stopnje vračanja izpušnih plinov na spremembo koncentracije škodljivih komponent v izpušnih plinih ($n = 1600 \text{ min}^{-1}$, $p_e = 9 \text{ bar}$)

Fig. 3. Effect of EGR rate on engine emissions ($n = 1600 \text{ min}^{-1}$, $p_e = 9 \text{ bar}$)

motorju z notranjim zgorevanjem. Metodo smo večkrat uspešno uporabili za obravnavani tlačno polnjeni motor, jo testirali s primerjavo računskih in eksperimentalnih rezultatov in podrobno predstavili v [7].

Uporabili smo dva simulacijska modela. Oba smo razvili iz osnovnega modela motorja in uporabili nekaj manjših sprememb polnilnega in izpušnega cevne sistema potrebnih za izvedbo vračanja izpušnih plinov po sistemu nizkega oz. visokega tlaka. Omejili smo se le na simulacijo obratovanja pri nizkih vrtilnih frekvencah motorja (1100 in 1300 min^{-1}) pri treh obremenitvah ($p_e=10\text{bar}$, $p_e=12\text{bar}$ in $p_e=14\text{bar}$). V teh obratovalnih razmerah je presežek zraka v tlačno polnjenem motorju najmanjši in potrebna je skrbna izbira stopnje recirkulacije izpušnih plinov, da se razmerje zrak – gorivo ne zmanjša pod kritično mejo (meja sajenja motorja) in koncentracija saj ne zveča čez vse meje. Povečanje tlaka v polnilnem zbiralniku za kompresorjem in s tem povečan pretok skozi motor je najučinkovitejši ukrep, da se temu izognemo. Zagotovimo ga lahko z uporabo turbine s spremenljivo geometrijsko obliko. Z nekoliko manjšo uspešnostjo (nižje stopnje vračanja) pa lahko uporabimo kar turbino z manjšim okrovom in sistemom obtekanja turbine, ki prek posebnega ventila prepušča del izpušnih plinov mimo turbine in preprečuje pojav dušenega toka v turbini pri velikih vrtilnih frekvencah motorja. Odločili smo se, da preizkusimo oba postopka. Zato smo stopnjo vračanja omejili na 10% pri polni obremenitvi ($p_e=14\text{bar}$) in jo nato stopnjevali do 20% pri 70-odstotni obremenitvi ($p_e=10\text{bar}$). Kakor so pokazale raziskave (slika 3), lahko pri teh stopnjah vračanja izpušnih plinov pričakujemo več ko 50-odstotno zmanjšanje koncentracije NOx.

2.1 Nizekotlačno vračanje izpušnih plinov

Tok vrnjenih izpušnih plinov poteka od izpušne cevi za turbino, prek filtra za saje, hladilnika izpušnih plinov in krmilnega ventila v sesalno cev motorja, kjer se pomeša s svežim zrakom (sl. 1). Delovanje krmilnega ventila smo simulirali z modelom lokalne spremembe tlaka [8]. Uporaba tega robnega

within the internal combustion engine. The method was successfully used for simulations of the investigated turbocharged diesel engine and it was tested against the experimental data. The method is presented in detail in [7].

Two simulation models were used. These models were based on the original engine model with some minor modifications necessary for setting up the EGR system. EGR concepts were simulated for three different EGR rates, at two engine speeds and three loads. The engine operation was studied only at low engine speeds (1100 and 1300 rpm , both at $p_e=10\text{bar}$, $p_e=12\text{bar}$ and $p_e=14\text{bar}$). Fresh-air excess is the lowest at these speeds, EGR can reduce the equivalent air-to-fuel ratio under the soot limit and the soot emission can increase dramatically. EGR rates, therefore, have to be chosen carefully. This problem can be avoided by the application of a variable geometry turbine (VGT). However, an appropriate size of turbine housing using the waste gate system can also do the job when the low-pressure EGR concept is applied and the EGR rate is kept small at high engine loads. It was decided, therefore, to graduate the rate of EGR from 10% at full engine load ($p_e=14\text{bar}$) to 20% at 70% of full engine load ($p_e=10\text{bar}$). These EGR rates normally ensure up to 50% NOx-emission reductions according to the experimental results presented in Fig. 3.

2.1 Low-pressure EGR

The low-pressure EGR system recirculates exhaust gas from below the turbine and EGR cooler (Fig. 1). The exhaust gas is supplied to the fresh-air side of the engine via a flow-control valve. Operation of the flow-control valve was simulated by the so-called "local pressure drop" boundary [8]. Using this

pogoja na stiku dveh cevi namreč omogoča spreminjanje stopnje vračanja izpušnih plinov. Model hladilnika vrtnjenih izpušnih plinov smo poenostavili in ga obravnavali kot nadzorno prostornino z okrepljenim prestopom toplote v okolico. Pri tem smo s primerno izbranim koeficientom prenosa toplote dosegli želeno temperaturo izpušnih plinov na izstopu.

Povečanje vrtilne frekvence turbo-kompresorja in s tem tlaka v polnilnem zbiralniku za kompresorjem smo dosegli z uporabo manjšega okrova turbine (GA19*11), katerega vstopni prerez je 27 % manjši od vstopnega prereza izvorne turbine (GA26*11) in je opremljen z obtočnim ventilom. Tako je bilo mogoče pri vseh obravnavanih režimih doseči predpisano stopnjo vračanja izpušnih plinov, ne da bi ob tem primerjalni razmerik zrak – gorivo padel pod mejno vrednost 1,4 (meja sajinja za obravnavani motor), kakor prikazuje slika 4.

2.2 Visokotlačno vračanje izpušnih plinov

Za visokotlačno vračanje smo uporabili dvovejni povratni sistem z dvema hladilnikoma izpušnih plinov. Izpušni plini izpred levega ali desnega vtoka v turbino lahko prek prenosnika toplote, krmilnega ventila in protipovratnega ventila tečejo v polnilno cev za kompresorjem in hladilnikom polnilnega zraka (sl. 2). Prav uporaba protipovratnih peresnih ventilov, ki jih pogosto srečamo pri dvotaktnih motorjih [9], omogoča izrabo tlačnih valov v izpušnem sistemu za stiskanje izpušnih plinov v polnilni sistem tudi pri negativni povprečni tlačni razliki ($p_3/p_2 < 1$). Ker vstopajo izpušni plini v polnilni sistem za kompresorjem in hladilnikom polnilnega zraka, odpadejo problemi zaradi povečane obrabe kompresorja in mašenja pretočnih kanalov prenosnika toplote.

Pravilno delovanje protipovratnih peresnih ventilov odločilno vpliva na uspešnost visokotlačnega vračanja. Za popis delovanja protipovratnih ventilov smo uporabili model pretoka skozi polnilni ventil motorja [8]. Značilni enosmerni pretok skozi smo dosegli z nizkimi

type of boundary it was possible to achieve different EGR rates. The EGR cooler model was simplified, and simulated as a single control volume with an increased convection heat transfer. The rate of convection heat transfer within the EGR cooler was intensified to a degree at which the recirculated exhaust gas left the water-cooled EGR heat exchanger at the desired temperature.

The turbocharger speed and, consequently, the boost pressure were increased by the application of a smaller turbine housing (GA19*11) equipped with a “Waste-Gate” valve. The inflow cross section of this turbine housing is 27 % smaller than the inflow cross-section of the original one (turbine housing GA26*11). This measure ensured the equivalent air-fuel ratio remained above 1.4 (soot limit) during all engine-operation regimes and with the desired EGR rate (Fig. 4).

2.2 High-pressure EGR

In this EGR configuration of a four-cylinder engine, a dual duct, cooled exhaust recirculation system was applied. The exhaust gas was withdrawn from either duct of the exhaust pipe above the turbine and fed to a reed valve (commonly used by two-stroke engines [9]) via a flow-control valve and an exhaust cooler (Fig. 2). The dual-duct configuration, which employs individual control valves, coolers and reed valves, makes use of the dynamic exhaust pressure. In this way, sufficiently high EGR rates were sustained even under negative mean differential pressures ($p_3/p_2 < 1$). The recirculated exhaust gas entered the charge air line downstream of the charge air cooler. This preserves the compressor and inter-cooler from increased wear and contamination.

The correct operation of the reed valves was crucial for this EGR concept. An adapted cylinder-valve boundary-condition model [8] was used for this simulation. The one-way operation of this valve was achieved by the application of a very low dis-

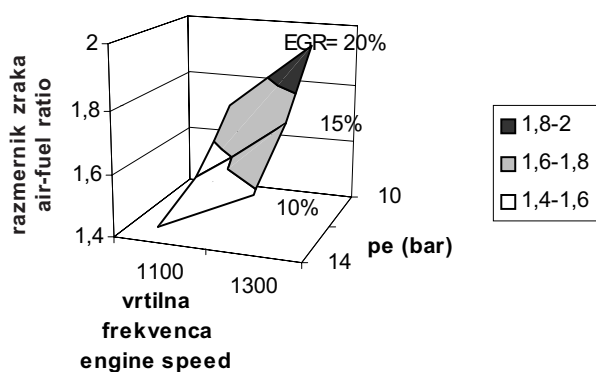

Sl. 4. Izračunani primerjalni razmernik zrak gorivo v sistemu z nizko-tlačnim vračanjem
Fig. 4. Predicted equivalent air-fuel ratio with low-pressure EGR

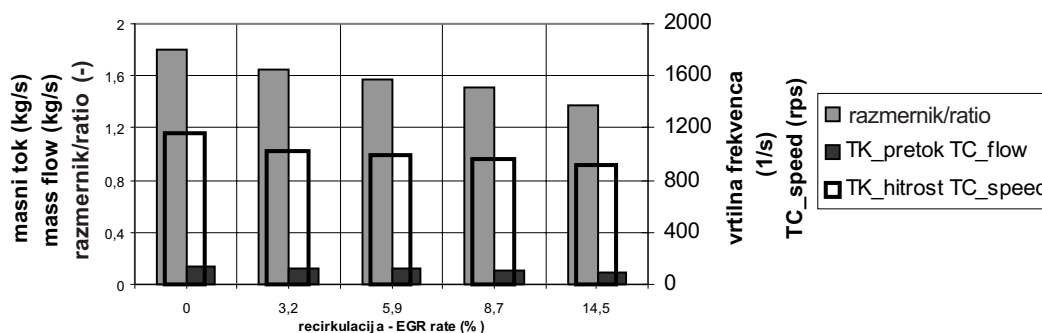

Sl. 5. Vpliv visoko-tlačnega vračanja na ekvivalentni razmernik zrak-gorivo ter na masni pretok in vrtilno frekvenco turbokompresorja ($n=1300 \text{ min}^{-1}$, $p_e=12\text{bar}$)

Fig. 5. Effects of application of high-pressure EGR on equivalent air-fuel ratio, mass flow rate and turbocharger speed ($n=1300 \text{ min}^{-1}$, $p_e=12\text{bar}$)

pretočnimi števili, ki smo jih predpisali za povratni tok. Tako smo dopustili majhno netesnost, kar ustreza dejanskim razmeram [9]. Preizkusili smo različne lege protipovratnega ventila v povratni veji in različne kombinacije ventilov. Ugotovili smo, da je najprimernejša uporaba dveh protipovratnih ventilov, ki sta nameščena na začetek in konec vsakega povratnega sistema. V takšni razporeditvi deluje prenosnik toplote kot nekakšen akumulator visokega tlaka. Prenos snovi v postopku vračanja izpušnih plinov je zato precej bolj ustaljen in ne vpliva negativno na delovanje kompresorja.

Ponovno smo skušali doseči višji tlak polnjenja kar z uporabo manjšega okrova turbine. Simulacije delovanja motorja z manjšim okrovom turbine GA19*11 in pri različnih stopnjah vračanja smo izvedli pri vrtilni frekvenci 1300 min^{-1} in 85-odstotni obremenitvi motorja ($p_e=12\text{bar}$). Vpliv stopnje visokotlačnega vračanja izpušnih plinov na izračunan masni pretok, vrtilno frekvenco turbokompresorja in ekvivalentni razmernik zrak – gorivo prikazuje slika 5. Visokotlačno vračanje izpušnih plinov močno vpliva na delovanje turbokompresorja. Zaradi zmanjšane pretoka skozi turbino se zmanjša moč turbine z njo pa vrtilna frekvenco turbokompresorja in tlak polnjenja (stopnja kompresije). Ustaljeno delovanje sistema motor – turbokompresor se zaradi tega vzpostavi pri precej nižjih obratovalnih parametrih (masni pretok, vrtilna frekvenco turbokompresorja, presežek zraka itn.). Zato želene 15-odstotne stopnje vračanja ne moremo doseči s primerjalnim razmernikom zrak – gorivo, ki bi bil višji od meje sajenja, saj je že pri 14,5-odstotni stopnji vračanja ekvivalentni razmernik le še 1,38 (sl. 5).

Potrebno povečanje tlaka polnjenja lahko torej dosežemo le z uporabo turbine s spremenljivo geometrijsko obliko. Delovanje turbine s spremenljivo geometrijsko obliko smo simulirali z modelom, ki izhaja iz modela dvonatočne turbine [10]. Tega sestavljajo trije pod-modeli: spiralni vodilnik, vmesni prostor in gonilnik. Model vmesnega prostora smo nadomestili z modelom obroča vodilnih lopatic [10]. Tako smo s spreminjanjem kota nagiba lopatic simulirali delovanje turbine s spremenljivo geometrijsko obliko ter pri enakih

charge coefficient for the reverse-flow operation, allowing very little leakage characteristic for the reed-valve operation [9]. The different positions and combinations of the reed valves were examined, and it was discovered that the application of the reed valve was optimum on each side of the EGR cooler. In this combination, the EGR cooler operated as a high-pressure accumulator, thus the mass transfer was smooth, without any extreme exhaust pressure pulses, which might have travelled through the EGR coolers into the intake system and interfered with the proper operation of the compressor, causing it to surge.

Firstly, any possibility of application for the turbocharger with a smaller turbine housing (GA19*11) was examined. Simulations of the engine operation using different EGR rates were performed at 1300 rpm and 85 % load ($p_e=12\text{bar}$). As shown in Fig. 5, high-pressure EGR dramatically affected the turbocharger's operation, because reducing the flow through the turbine decreased the turbine output. The turbocharger speed and boost pressure, therefore, decreased as well. The steady-state operation of the turbocharger-engine system was reached at significantly lower engine-operation parameters (mass flow, turbocharger speed, equivalent air to fuel ratio, etc.), and the desired EGR rate (15% at this load) could not be obtained when the air-to-fuel ratio was above the soot limit (λ is 1.38 at 14.5 % EGR rate – Fig. 5).

This problem can be solved by the application of a variable-geometry turbine. The simulation of the variable-geometry turbine operation was performed by a turbine model adapted from a twin-turbine model [10]. This model consists of three sub-models: the spiral volute, the interspace and the turbine rotor. In the adapted model the model of interspace between the volute and rotor was supplemented, however, by guide vanes [10]. The angle of the guide vanes was varied during simulations, and the flow-control valve was adjusted simultaneously in order to achieve the same boost pressure and the

stopnjah vračanja z visokotlačnim postopkom dosegli enake tlake polnjenja kakor pri nizkotlačnem vračanju izpušnih plinov. Na sliki 6 je prikazan kot nagiba vodilnih lopatic, ki je potreben, da so stopnja vračanja, tlak polnjenja in preostali parametri obratovanja motorja enaki kakor pri nizkotlačnem postopku. Potrebno je bilo precejšnje pripiranje turbine, saj so koti nagiba vodilnih lopatic do 40% manjši od srednjega kota iztekanja ($\alpha_s = 20^\circ$) iz izvirnega turbinskega okrova GA19*11, ki je brez obroča vodilnih lopatic.

3 PRIMERJAVA NIZKO- IN VISOKOTLAČNEGA POSTOPKA VRAČANJA

Rezultati računalniških simulacij so pokazali, da je mogoče tako z nizko- kakor z visokotlačnim sistemom dosegati enake stopnje vračanja izpušnih plinov. Predpostavimo torej lahko, da sta oba postopka enako učinkovita z vidika zmanjševanja emisije NOx. Delovanje turbokompresorja v obeh sistemih pa se precej razlikuje. Masni pretok skozi kompresor in turbino je pri visokotlačnem postopku manjši kakor pri nizkotlačnem. Relativna razlika znaša prav toliko, kolikor je stopnja vračanja. Zmanjšan masni pretok lahko ogrozi stabilno delovanje kompresorja, saj se delovne točke pomaknejo bliže k meji črpanja, kakor to prikazuje slika 7. Delovne točke kompresorja v sistemu z nizko-tlačnim postopkom vračanja so tik ob delovnih točkah kompresorja testnega motorja brez regeneracije. V sistemu z visokotlačnim postopkom so se delovne točke precej bolj približale meji črpanja. Kadar se takemu premiku pridružijo še tlačni valovi, ki se prek visokotlačnega recirkulacijskega sistema razširijo v polnilno cev, lahko postane delovanje kompresorja nestabilno.

Potovanje tlačnih valov skozi visokotlačni povratni sistem lahko preprečimo z uporabo dveh protipovratnih ventilov. Pri tem je prvi postavljen na vstopu drugi pa na izstopu iz sistema. Pri tem deluje hladilnik izpušnih plinov kot visokotlačni akumulator. To podaljša obdobje polnjenja polnilne cevi z izpušnimi plini in zmanjša intenzivnost pretoka. Kakor

same EGR rates as with the low-pressure EGR concept. A diagram of the guide-vanes angle used in the simulations of the high-pressure EGR concept using the VG turbine is shown in Fig. 6. The mean volute outflow angle of the original turbine without guide vanes was $\alpha_s = 20^\circ$. As can be seen from Fig. 6, an almost 40 % reduction of the flow angle was necessary for the operation of high-pressure EGR with the same engine system performance as low-pressure EGR in terms of the operational parameters.

3 COMPARISON OF LOW- AND HIGH-PRESSURE EGR

The computations showed that similar EGR rates can be generated in both high- and low-pressure EGR configurations. Since the charge-mixture temperatures did not differ significantly, it can be assumed that the NOx-emission reduction is also similar for both concepts. The operation of the turbocharger, however, differed significantly with both EGR systems. In contrast to low-pressure EGR, the total air mass flow through the compressor and through the turbine decreased when using high-pressure EGR. This mass flow reduction is equal to the EGR rate, and may cause the compressor operation to be near, or even within, the non-stable surge region. Figure 7 shows the effects of EGR on the positions of the compressor's operational points on the compressor map. The compressor operational points using low-pressure EGR were located close to the compressor operational line of the original test engine, while the compressor operational points using high-pressure EGR shifted towards the surge line. When this shift is accompanied by pressure pulses passing through the high-pressure EGR system, compressor surge might occur.

The application of the reed valve on both sides of the EGR cooler hinders the pressure pulses when travelling through the EGR cooler. Moreover, in this configuration the EGR cooler operated as a high-pressure accumulator and distributed the recirculated exhaust gas into the intake system for an interval that was much longer than the filling period of the EGR cooler. The velocity and

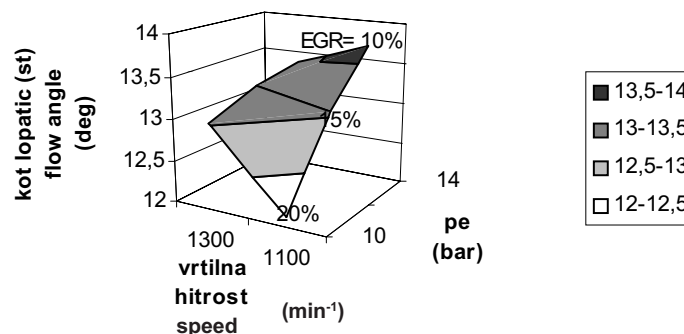

Sl. 6. Sprememba kota naklona vodilnih lopatic turbine – visoko-tlačni sistem vračanja
Fig. 6. Map of guide vane angles for VG turbine in combination with high-pressure EGR

prikazuje slika 8, se največja hitrost plinov od vstopa v sistem do izstopa iz njega zmanjša od 140 m/s na 25 m/s, tlačna amplituda pa se zmanjša z 0,4 bar na 0,05 bar.

Kljub temu, da je masni pretok skozi valje motorja enak, pa obstajajo pomembne razlike med postopkoma izmenjave delovne snovi v obeh sistemih. Primerjavo potekov tlaka v valju prikazuje slika 9. Med izpuhom se tlak v valju pri sistemu z visokotlačnim vračanjem znižuje precej hitreje kakor pri sistemu z nizkotlačnim vračanjem, saj izpušni

pressure pulses transferred into the intake system, therefore, were low (Fig. 8), and did not interfere with the compressor's operation. The maximum exhaust-gas velocity was reduced from 140 m/s at the EGR system's inflow side to 25 m/s at the outflow side, and similarly the pressure amplitude was reduced from 0.4 bar to 0.05 bar.

Although the mass flow through the engine cylinders and the boost pressure were similar in the cases of both EGR configurations, there were some evident differences during the gas-exchange process. In-cylinder pressure-time histories are compared in Fig. 9. During the

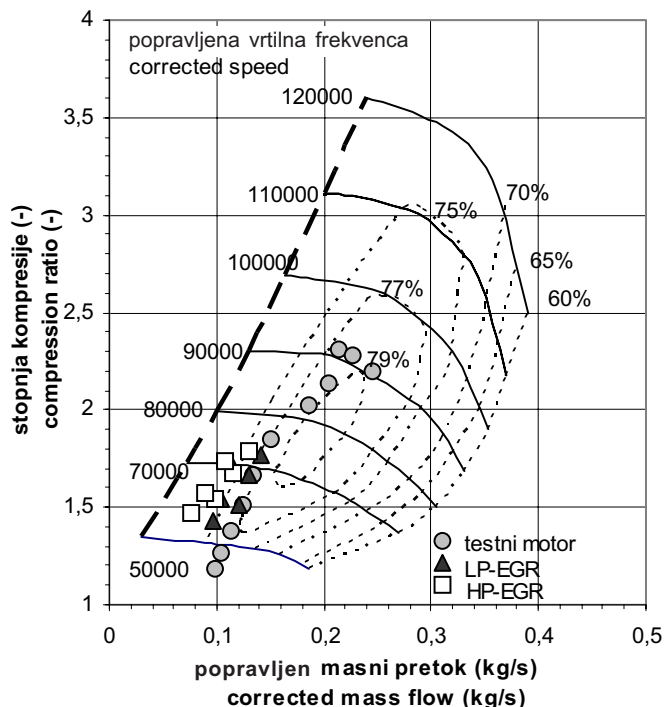

Sl. 7. Delovne točke kompresorja za motor brez vračanja, motor z nizko-tlačnim vračanjem (LP-EGR) in motor z visoko-tlačnim vračanjem (HP-EGR)

Fig. 7. The original test engine, the low-pressure EGR concept (LP-EGR) and the high pressure EGR concept (HP-EGR) compressor operational points

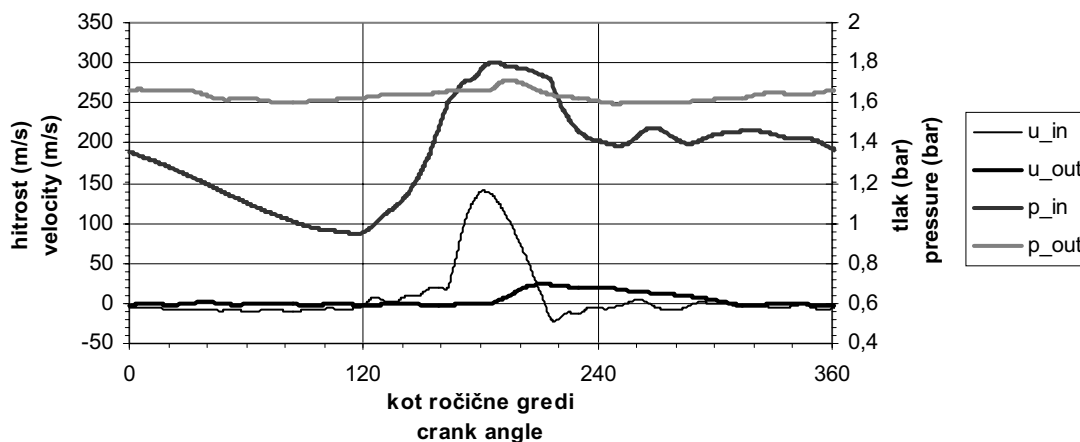

Sl. 8. Potek tlaka in hitrosti pred (p_{in} , u_{in}) in za hladilnikom izp. plinov (p_{out} , u_{out}) – visoko-tlačno vračanje

Fig. 8. Pressure- and velocity- time histories at the EGR cooler entry (p_{in} , u_{in}), and at the EGR cooler exit (p_{out} , u_{out}) - high-pressure EGR

Preglednica 2. Primerjava relativnega indiciranega dela izmenjave delovne snovi za sistem z nizkotlačnim (LP) in visokotlačnim (HP) vračanjem

Table 2. Comparison of relative indicated pumping work with low-pressure (LP) and high-pressure (HP) EGR configuration

	$p_e=14$ bar, EGR=10%		$p_e=12$ bar, EGR=15%		$p_e=14$ bar, EGR=20%	
	LP	HP	LP	HP	LP	HP
1100 min^{-1}	0,75%	0,54%	0,54%	0,35%	0,39%	0,18%
1300 min^{-1}	0,12%	-0,17%	0,00%	-0,13%	-0,24%	-0,35%

plini hkrati ekspandirajo skozi turbino in v hladilnik izpušnih plinov. V trenutku, ko se na vstopnem protipovratnem ventilu vzpostavi negativno tlačno razmerje, se tlačni valovi odbijejo od njega nazaj v izpušni sistem. Tlak v izpušnem sistemu se zato zviša, z njim pa tudi tlak v valju. Ta sekundarni tlačni val vpliva na postopek izmenjave delovne snovi na dva načina. Močno se poveča masa zaostalih izpušnih plinov in poveča se delo, potrebno za izmenjavo delovne snovi. Povečanje mase zaostalih plinov (do 15 %) lahko štejemo za pozitiven učinek, saj poveča stopnjo vračanja, medtem ko pa je povečanje dela potrebnega za izmenjavo delovne snovi, nezaželeno.

V preglednici 2 je prikazano indicirano delo, potrebno za izmenjavo delovne snovi, ki smo ga določili z numerično integracijo izračunanega tlaka v valju motorja. Rezultati so podani v obliki relativnih deležev srednjega dejanskega dela. Delo izmenjave delovne snovi je pri vrtilni frekvenci motorja 1100 min^{-1} pozitivno v vseh primerih, pri 1300 min^{-1} pa je pozitivno le v sistemu z nizkotlačnim vračanjem. V povprečju je relativno delo izmenjave delovne snovi v sistemu z nizkotlačnim vračanjem za 0,1 do 0,3-odstotne točke manjše. Zato lahko sklepamo, da je dejanski izkoristek motorja z nizkotlačnim vračanjem v enaki meri (0,1 do 0,3-odstotne točke) večji.

exhaust period using high-pressure EGR the in-cylinder pressure decreased much faster, because the exhaust gases expanded into the EGR cooler and through the turbine at the same time. Once the pressure difference at the EGR cooler entry became negative, however, the pressure pulses were reflected from the reed valve back to the exhaust system, and both the exhaust system and the in-cylinder pressures increased. This secondary pressure pulse deteriorated the gas-exchange process in two ways. The residual gas mass fraction increased, and the pumping work, necessary for gas exchange, also increased. Up to 15 % higher residual mass fraction was observed using high-pressure EGR. Since this helped to increase the EGR rate the effect was regarded as positive. The increased pumping work reduced the overall engine efficiency and had a negative effect.

The indicated pumping work calculated from the computed in-cylinder pressure traces for both EGR configurations is presented in Table 2 and expressed as a percentage of the total effective work. The positive values relate to 1100 rpm, and the negative values to a 1300-rpm high-pressure EGR operating regime. The low-pressure EGR relative pumping work shows between 0.1 and 0.3 percentage points higher than its relative value for high-pressure EGR. It may, therefore, be assumed that the same difference (between 0.1 and 0.3 percentage points) also exists between the overall engine efficiencies.

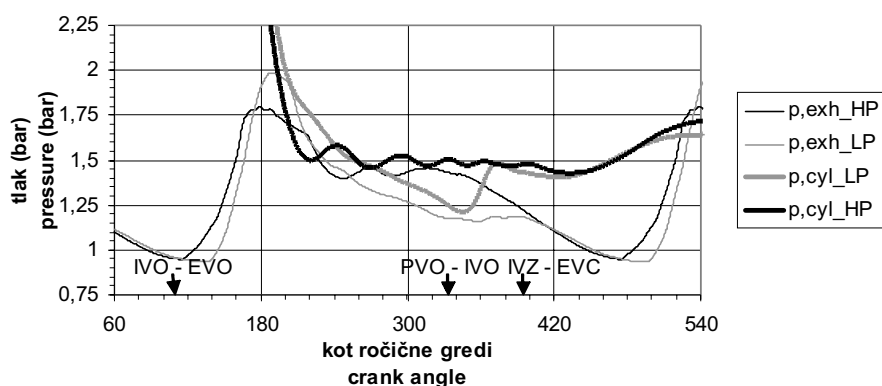
Sl. 9. Potek tlaka v valju in v kanalu izpušnega ventila za motor z nizko-tlačnim (p,cyl_LP , p,exh_LP) in visoko-tlačnim vračanjem (p,cyl_HP , p,exh_HP)Fig. 9. Comparison of pressure-time histories within the cylinder and exhaust manifold with low-pressure GR (p,cyl_LP , p,exh_LP) and high-pressure EGR (p,cyl_HP , p,exh_HP)

4 SKLEP

V prispevku smo prikazali rezultate meritev vpliva vračanja izpušnih plinov na emisijo škodljivih komponent v izpušnih plinih. Ugotovili smo, da že 10-odstotna stopnja vračanja prepolovi emisijo NO_x, pri čemer se emisija preostalih škodljivih komponent ne poveča pomembno. Šele pri 20-odstotni stopnji vračanja se močno zvečajo koncentracije CO in saj. Te ugotovitve smo upoštevali v nadaljevanju, ko smo z uporabo enorazsežne numerične simulacije ovrednotili dva postopka recirkulacije izpušnih plinov v 4-valjnem tlačno polnjenem dizelskem motorju. Na podlagi računskih rezultatov lahko podamo naslednje ugotovitve:

- Z obema postopkoma nizekotlačnim in visokotlačnim je mogoče doseči stopnje vračanja med 10 in 20 %, ki zagotavljajo občutno znižanje NO_x.
- V sistemu z nizekotlačnim postopkom za povečanje tlaka polnjenja in ohranitev zadostnega presežka zraka zadošča manjši okrov turbine z obtočnim ventilom.
- V sistemu z visokotlačnim postopkom se turbina z manjšim okrovom ne obnese. Potrebna je turbina s spremenljivo geometrijsko obliko, da hkrati povečamo učinek turbo-kompresorja in stopnjo vračanja.
- Nizekotlačni postopek vračanja ne vpliva na postopek izmenjave delovne snovi. Prostorninski izkoristek, koeficient zaostalih plinov in delo izmenjave delovne snovi ostanejo enaki kakor v primeru motorja brez regeneracije.
- Z visokotlačnim postopkom se poveča poraba dela za izmenjavo delovne snovi. Pripomniti pa velja, da smo obdržali nespremenjene krmilne čase ventilov in da bi se lahko z njihovim optimiranjem razmere izboljšale.

4 CONCLUSIONS

The influence of exhaust-gas recirculation on engine emissions was experimentally investigated. It was found that a 10 % EGR rate halved the NO_x emissions and did not increase the emissions of other pollutants significantly. A drastic increase in CO and soot emissions was observed at 20 % EGR. These stating were considered in the continuation where the applications of two different EGR configurations on a four-cylinder, turbocharged diesel engine were studied by means of a one-dimensional simulation. Based on the computational results the following conclusions can be reached:

- for both the configurations investigated it was possible to achieve EGR rates in a range between 10 % and 20 %, which reduce NO_x emissions significantly.
- the application of a smaller turbine housing was successful for increasing the boost pressure and maintaining the air-to-fuel ratio above the soot limit when the low-pressure EGR concept was applied.
- the smaller turbine housing did not work for the high-pressure EGR concept, and the application of a variable-geometry turbine was necessary in order to simultaneously increase the turbocharger performance and the EGR rate.
- the low-pressure EGR configuration did not interfere significantly with the gas-exchange process. The pumping work, volumetric efficiency, and residual gas fraction remained the same as in the case of the original engine scheme.
- a deterioration in the gas-exchange process parameters was noticed using the high-pressure EGR configuration. Optimisation of the valve timing, however, which might have improved the effective engine data was not taken into consideration.

5 LITERATURA

5 REFERENCES

- [1] Needham, J.R., D.M. Doyle, A.J. Nicol (1991) The low NO_x truck engine, *SAE Paper 910731*.
- [2] Heywood, J.B. (1988) Internal combustion engine fundamentals, *McGrawHill*, New York.
- [3] Ached, N., U.D.T. Sat, H. Sugar (1993) *Combined effects of EGR and supercharging on diesel combustion and emissions*, *SAE Paper 930601*.
- [4] Odaka, M., N. Koike, Y. Tsukamoto, K. Narusawa (1992) Optimizing control of NO_x and smoke emissions from DI engine with EGR and methanol fumigation, *SAE Paper 920468*.
- [5] Kohketsu, S., K. Mori, K., Sakai, T. Hakozaki (1997) EGR technologies for a turbocharged and intercooled heavy-duty diesel engine, *SAE Paper 970340*.
- [6] Schmitt, F., A. Lingens (2001) The potential of different exhaust gas recirculation systems, *AutoTechnology 2/2001*, 70–73.
- [7] Hribernik, A. (1995) Primerjava brez- in enodimenzionalnih metod za simuliranje procesov v tlačno polnjenem dizelskem motorju, *Strojniški vestnik*, let. 41, št. 7-8, 229-238.
- [8] Benson, R.S. (1982) The thermodynamic and gas dynamics of internal-combustion engines, Vol. I, *Clarendon Press*, Oxford.
- [9] Hinds, E.T., G.P. Blair, Unsteady gas flow through reed valve induction system, *SAE Paper 780766*
- [10] Hribernik, A. (1994) Modeliranje robnih pogojev dvonatočne turbine turbokompresorja vozilskega dizel motorja, doktorska disertacija, Maribor.

Naslov avtorjev: doc. dr. Aleš Hribernik
mag. Gorazd Bombek
Fakulteta za strojništvo
Univerza v Mariboru
Smetanova 17
SI-2000 Maribor
ales.hribernik@uni-mb.si
gorazd.bombek@uni-mb.si

Author's Address: Doc. Dr. Aleš Hribernik
Mag. Gorazd Bombek
Faculty of Mechanical Eng.
University of Maribor
Smetanova 17
SI-2000 Maribor, Slovenia
ales.hribernik@uni-mb.si
gorazd.bombek@uni-mb.si

Prejeto: 22.10.2003
Received:

Sprejeto: 12.2.2004
Accepted:

Odprto za diskusijo: 1 leto
Open for discussion: 1 year