

Simulating Nonlinear Materials under Centrifugal Forces by using Intelligent Cross-Linked Simulations

Reinhard Hackenschmidt* – Bettina Alber-Laukant – Frank Rieg
University of Bayreuth, Department of Engineering Design and CAD, Germany

Actual sophisticated development processes are conducted by the use of multiple computer-aided tools (CAx-tools) to accelerate product development. However, because of below optimal simulation strategies and procedure guidelines mainly for complex materials and loading the development process is constricted and hence sluggish. The main emphasis of the article is to show how Intelligent CROss-linked Simulations (ICROS) methodical approach can be used to handle complex processes supported by specific computer techniques employed. Development of an elastomer insert subassembly for a standard claw coupling is used as an example of such a complex process.

©2011 Journal of Mechanical Engineering. All rights reserved.

Keywords: product development, CAx, ICROS, FEA, simulation, workflow

0 INTRODUCTION

Classical claw couplings (Fig. 1) are flexible and designed for positive torque transmission. They are fail-safe. Operational vibrations and shocks are efficiently dampened and reduced with the use of an elastomeric insert element to be located between metal parts. The two congruent coupling halves with concave claws on the inside are peripherally offset in relation to one another by half a pitch.



Fig. 1. *Standard Claw coupling*

To broaden the clutches technical field of application for up to 40,000 rpm high-speed rotating drive-trains, the question of material distortion both under centrifugal / torque and compression load has to be investigated. To avoid costly hardware experiments, the development of

an effective simulation solution, also transferable to a wide range of couplings with different nominal torques had top priority.

As the use of a variety of different computer-aided tools (CAx-tools) e.g. for strength of material and manufacturing simulations is necessary for a useful outcome, the methodical approach based on Intelligent CROss-linked Simulations (ICROS) was chosen to optimize the virtual simulation process chain as presented in subsequent sections of this paper.

1 RELATED RESEARCH

Product development as a whole consists of many sub-processes that have to be performed in specific order. These processes are also iterative and linked to certain product-specific data. By a detailed analysis of these processes, their functionalities and complex interactions can be uncovered. There were many attempts to improve the product development processes in industry, from traditional phase-gate approach [1] to more efficient set-based concurrent engineering [2].

In order to achieve a better organisation and an efficient use of available product development, computer-aided tool, the Artificial Intelligence (AI), has been extensively applied [3] to [5], along with other multi-criteria analyses [6] and [7].

Despite all the proven benefits of modern engineering software, one of the main problems existing today in the development process is the

*Corr. Author's Address: University of Bayreuth, Department of Engineering Design and CAD, 95440 Bayreuth, Germany, konstruktionslehre@uni-bayreuth.de

Babylonian-like system variety and complexity. On the one hand, as discussed in [8], the conflicts in-house use of multiple systems, programs and simulation tools may lead to coordination problems.

On the other hand, the complexity of global supplier structures with their own simulation systems also creates significant handling problems (Fig. 2).

When designing complex products, often various special analysis tools need to be applied [10]. Moreover, sometimes even different shape models representations are needed to perform the analysis [11]. In addition, the existing sequence of simulation tools does not adequately model fibre reinforced polymer parts [12].

Depending on their relations single sub-processes can be composed to complete process-chains up to adequate support during the post-

processing phase by the use of e.g. intelligent rule-based consultative system [13].

It can be concluded that the achievement of adequate coordination of multiple simulation programs still represents a bottleneck in the product development process.

2 ICROS

To ensure a reliable accomplishment of product development by using multiple simulation programs ICROS recommends to organize the procedural method following the widespread four step engineering design approach according to Pahl/Beitz [14] or the VDI 2221 [15]. This basic approach only has to be adapted from product design in a way that it can support process design [16]:

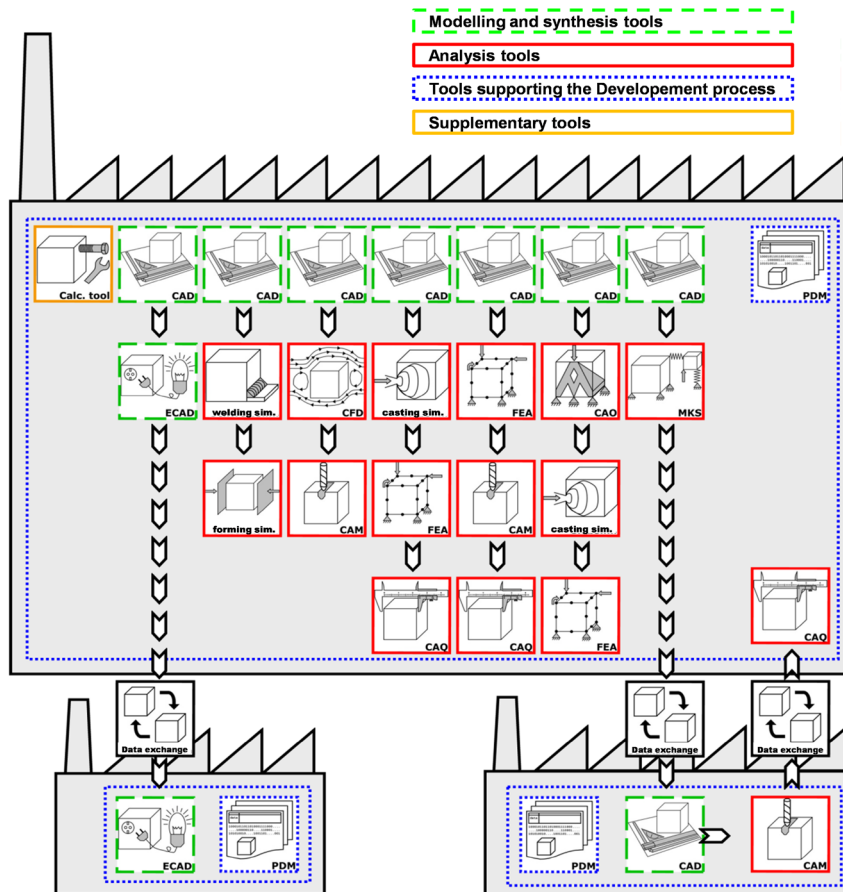

Fig. 2. Complex simulation tool environment [9]

- First step: Clarification and specification of task and simulation needs.
- Second step: Conceptual design of the simulation needs.
- Third step: Design of the simulation scenario.
- Fourth step: Development of a suitable simulation environment.

A detailed discussion about the application of methods, processes and instruments is made in advance. This approach stimulates the use of adequate virtual design tools already in the early phase of the overall process.

In the same way, it also determines the criteria and information that has to be carried along the way through all the design and simulation steps. With qualified information about the simulations needed and the CAE-software available decisions about either reserving capacities in the in-house CAE-department or the necessity for contacting external service providers, is facilitated. This is fundamental for developing generic simulation process chains, and also for the outline of a project-based workflow and timeline.

Detailed decisions about programs, operating systems and adequate hardware have to be made under the viewpoint of necessary functionality and existing system environment. It is fundamental to know the detailed program capacity and coverage of internally available or even externally used programs. If, for example, a part out of a material with non-linear behaviour has to be developed, the simulation tool needs to be able to cope with inhomogeneous material.

The results of the examinations have to be fixed to all necessary details, in corresponding worksheets. This ranges from correct export-and import-formats, including corresponding settings, to detailed support in order to resolve interdependencies of results or design tasks. These should be provided on an effective level of granularity to take account of software- and user-specific circumstances. They can be combined to form a holistic environment, which is used in this specific development task. The abstraction to a generalized and certifiable process chain later on is easily possible.

This will lead to a dramatic improvement in coping with challenging tasks, especially in today's multinational and complex relations between customers and tiers. The precise analysis

of the main tasks to be performed in this complex development process determines that especially the simulation phase itself has to be supported by documents that help the designer to choose the right simulation features or, if experienced designers are involved, represent special topics seldom used or critical (Fig. 3). In this way, also internal regulations or legal restrictions can be provided on the spot after a full ICROS-schema is developed.

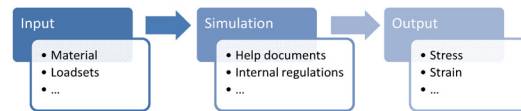

Fig. 3. Required input data / generated output data for simulation processes

3 CLAW CLUTCH DEVELOPMENT USING ICROS

The design of a claw coupling with elastomeric damping elements is a challenging task, especially if high speed rotational frequencies are claimed for its application. Without doubt, the specification list according to Pahl/Beitz [14] is a basic prerequisite for the engineering task as here all the technical needs have to be defined.

The discussed clutch application assumes mainly correct dimensioning of the polymer part. Hence, there is a need for adequate computer-aided simulation tools to predict the material behaviour.

As polymers are widely non-linear in their characteristics, in the first ICROS step the variety of software to be considered has to be selected. Table 1 shows a representative list.

Table 1. Software selection list excerpt for polymer mechanical stability calculation

Program	Linear / nonlinear	Version
MSC.Marc	y/y	Marc 2010
Abaqus	y/y	Explicit or Implicit 6.10
ProMECHANICA	y/n	Wildfire 5
Z88Aurora	y/y	V2
...

The list has to be verified and completed by other necessary programs to meet all requirements in regard to all the simulation needs. In the second ICROS step the simulation program requirements for the entire simulation chain were discussed and fixed for all the necessities of the project:

- centrifugal force load calculation,
- mould injection behaviour,
- displacement simulation,
- die casting mould machining.

This leads to a well-defined list of programs (Table 2), which are of course adjustable and adaptable due to the companies' standards and prerequisites.

Table 2. Overall software selection list excerpt

Task	Program
Centrifugal Forces	Abaqus
	MSC.Marc
Displacements	Abaqus
Injection moulding	Moldex3D
	Moldflow
Mould machining	ProMECHANISM
...	...

A typical simulation program flow suggestion for such an engineering design problem can be found in ICROS' standardized workflow diagrams and has to be adapted to the concrete task in the third ICROS step (Fig. 4).

The classical approach along the ICROS path with modelling the clutch in the 3D-CAD system followed by a linear FEM calculation under high rotation speed (28,000 rpm) plus torque load (60 Nm) of the charged insert-clutch-contact areas lead to fundamental results (Fig. 5).

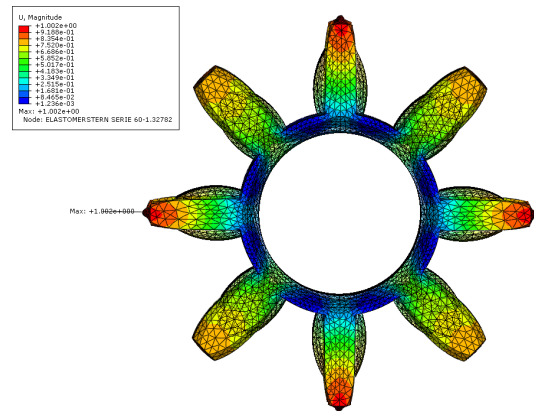

Fig. 5. First simulation results

Firstly, due to the rotation load, the displacement areas show significant radial deformation of the elastomeric insert. Secondly, the torque burdened areas are partially disabled in their distortion; that is the reason why the appropriate regions differ from the others. These results represent the reality very well in principle, but unfortunately the absolute figures as seen in Table 3 are some order of magnitudes too high as compared with a physical high speed test on a specially developed high speed test bench.

Table 3. Simulation vs. experimental results

	Linear Simulation	Non-linear Simulation	Test
Displacement max [mm]	1.0	1.3	1.7

Here, it was a great challenge to measure the radial polymer deformation values at the clutch while rotating up to 40,000 rpm. It was realized by the use of a light beam in combination with a highly sensitive photo cell, delivering the strength

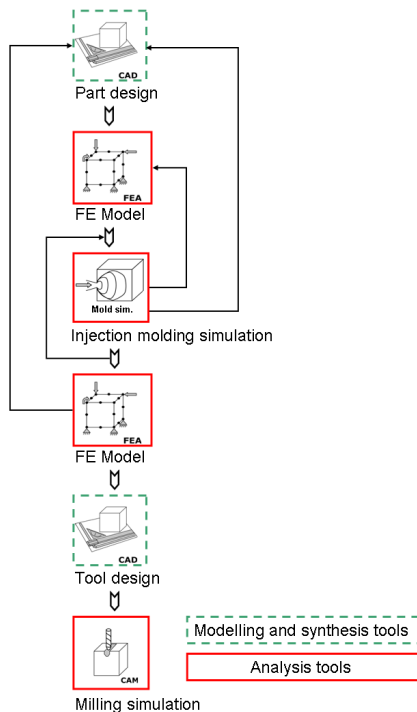

Fig. 4. Standard process workflow for polymer simulation processing

of current according to the real deformation peak of the elastomeric element. Not only maximum but also enduring distortion and time dependent creeping effects could be measured very precisely.

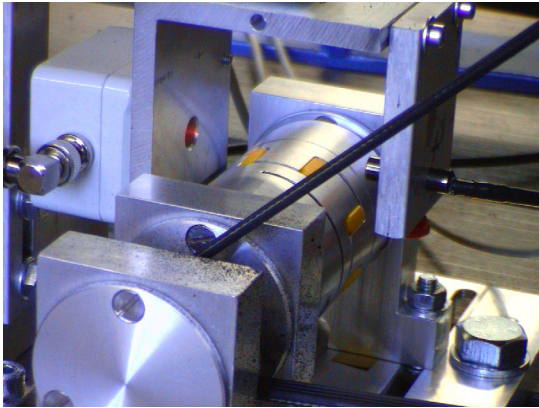

Fig. 6. High-speed test bench

To ensure reliable simulation results, it was found that the use of linear material parameters determined out of standard pulling tests as provided e.g. by the producer of elastomeric materials, do not fit the real material values. The explanation lies in the specific material behaviour: For reasons of expense, thermoplastic elastomers (TPE) are used. These materials are either copolymers or physically mixed polymers.

Compared to common thermoset elastomers with chemical bonding these special thermoplastic elastomer blends have a physically cross linking depending on their hard/soft segmentation of the blend components (see Figs. 7a and b). Therefore, by room temperature and moderate forces they act like real elastomers only with the help of semi crystalline agglomerations and the resulting van der Waals forces.

The properties lie between both materials thermoplastic and elastomers (see Fig. 7c).

In spite of elastomers the production of TPE is quite simple owing to the use of standard injection moulding processes (Fig. 8). Nevertheless, the most important difference between thermoset elastomers and thermoplastic elastomers is the type of the cross-linking bond in their structures. The cross-linking mechanism of TPE strongly depends on the fabrication process and differs substantially. The behaviour cannot be simulated in its complexity. To ensure that TPE's

behaviour is neither linear elastic nor viscoelastic, an additional simulation with a hyperelastic material model was done which produced more realistic results but they did not fit the above pattern at all.

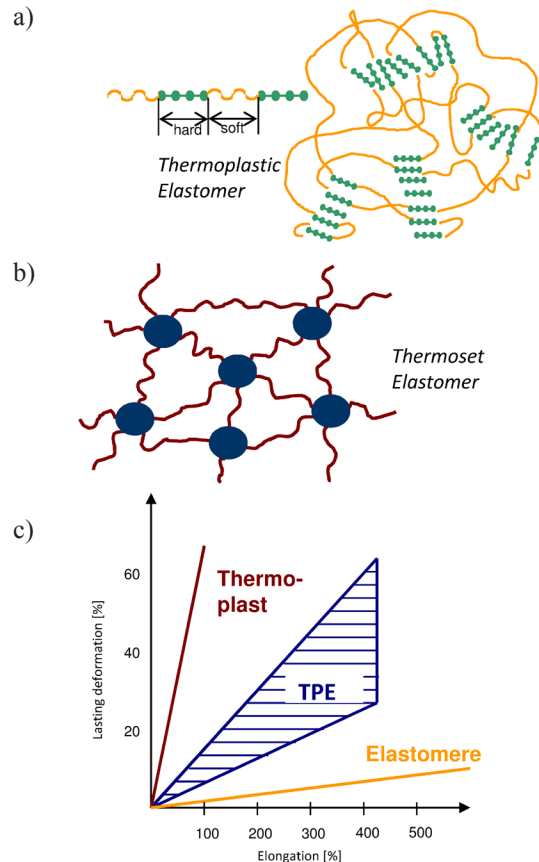

Fig. 7. Conformation and properties of thermoplastic elastomers and thermoset elastomers

Different material models like Mooney Rivlin, Neo Hooke, Yeoh, Ogden, Marlow or Arruda-Boyce are suitable to deal with the problem.

The chosen material model is a hyper elastic model of Ogden which depends on the principle stretch ratios λ_i .

$$U = \sum_{i=1}^N \frac{2\mu_i}{\alpha_i^2} \left(\overline{\lambda_1^{\alpha_i}} + \overline{\lambda_2^{\alpha_i}} + \overline{\lambda_3^{\alpha_i}} - 3 \right) + \sum_{i=1}^N \frac{1}{D_i} (J_{el} - 1)^{2i},$$

$$\overline{\lambda_i} = J^{-\frac{1}{3}} \lambda_i, \quad (1)$$

and α_i , μ_i , D_i are to be determined from experimental test data [17].

Additionally, known hardening effects of elastomeric parts under pressure load [18] led to a conclusion that for the investigated clutch part, a specific determination of the material parameters is indispensable.

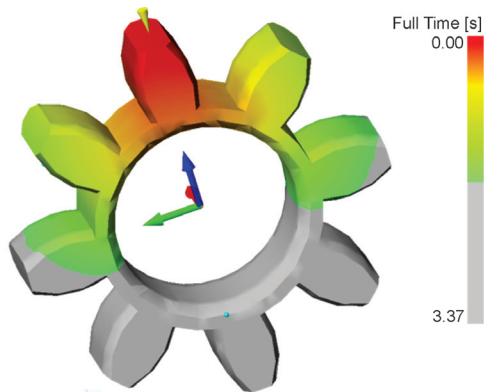

Fig. 8. Insert mould process simulation results

Hence, a part specific pulling rig was developed for the use on a standard Zwick testing machine (Fig. 9).



Fig. 9. Insert pulling rig

The resulting material parameters served as mapping basis for the FEM model in an adequate non-linear FEM tool. The comparison of the results shows that the simulation data are very close to the measured reality, leading to the

manufacturing approval of the mould forms and materials procurement. It should be stated that some additional improvement loops on behalf of the geometrical attributes of the clutch and insert geometry were also performed. Conducting thoroughly this fourth ICROS step results in the development of a detailed simulation workflow plan perfectly suitable for the task (Fig. 10).

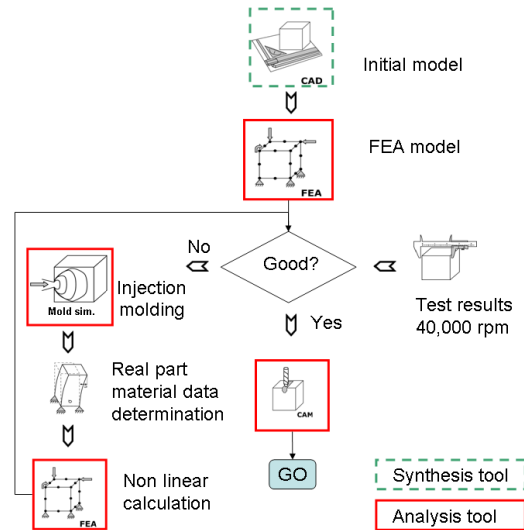

Fig. 10. ICROS high-speed simulation workflow overview

The findings of this specific task according to the simulation tool needs and interactions are added to the general ICROS case database and can be used for related virtual development tasks.

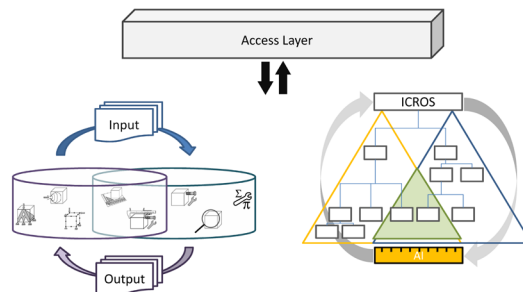

Fig. 11. Combination of ICROS with AI for exceptional problems

To face these challenges, engineers should have direct contact to the best practices for their current simulation step [19]. Ideally, it is essential to provide them with the necessary information according to their respective design experience without constraining their creativity. This case sensitivity could be managed with the help of AI (Fig. 11).

4 RESULTS AND CONCLUSIONS

Due to the requirement of being able to handle centrifugal forces and distortions resulting from a very high rotating speed applied on nonlinear elastomer, the finding of an optimized virtual simulation tool dedication was investigated. It could be pointed out that material properties can be mapped and scaled to a computer model by a skilled combination of virtual product design and prototype testing using the ICROS method presented.

With the help of adequate methods like AI it should even be possible to come to an automatic case covering detection system to effectively support engineer in developing processes.

5 REFERENCES

- [1] Morgan, J.M., Liker, J.K. (2006). *The Toyota product development system: integrating people, process and technology*. Productivity Press, New York.
- [2] Raudberget, D. (2010). Practical applications of set-based concurrent engineering in industry. *Strojniški vestnik - Journal of Mechanical Engineering*, vol. 56, no. 11, p. 685-695.
- [3] McMahon, C., Lowe, A., Culley, S. (2004). Knowledge management in engineering design: Personalization and codification. *Journal of Engineering Design*, vol. 15, p. 307-325.
- [4] Sancin, U., Dobravec, M., Dolšak, B. (2010). Human cognition as an intelligent decision support system for plastic products' design. *Expert Systems with Applications*, vol. 37, p. 7227-7233.
- [5] Dolšak, B. (2002). Finite element mesh design expert system. *Knowledge-Based Systems*, vol. 15, no. 5-6, p. 315-322.
- [6] Kostanjevec, T., Polajnar, A., Kostanjevec, M. (2009). Product development simulation with multicriteria analysis. *International Journal of Simulation Modelling*, vol. 8, no. 1, p. 38-47.
- [7] Fain, N., Moes, N., Duhovnik, J. (2010). The role of the user and the society in new product development. *Strojniški vestnik - Journal of Mechanical Engineering*, vol. 56, no. 7-8, p. 521-530.
- [8] Dolšak, B., Novak, M. (2011). Intelligent decision support for structural design analysis. *Advanced Engineering Informatics*, vol. 25, p. 330-340.
- [9] Goering, J.U. (2007). *Kopplung und prozessorientierte Verknüpfung der Methoden und Werkzeuge. FORFLOW - Bayerischer Forschungsverbund für Prozess- und Workflowunterstützung zur Planung und Steuerung der Abläufe in der Produktentwicklung: 1. Ergebnisbericht*, Erlangen, p. 87-98.
- [10] Chen, D.C., Chen, W.J., Lin, J.Y., Jheng, M.W., Chen, J.M. (2010). Finite element analysis of superplastic blow-forming of Ti-6Al-4V sheet into closed ellip-cylindrical die. *International Journal of Simulation Modelling*, vol. 9, no. 1, p. 17-27.
- [11] Hamri, O., Léon, J.C., Giannini, F., Falcidieno, B. (2010). Computer aided design and finite element simulation consistency. *Strojniški vestnik - Journal of Mechanical Engineering*, vol. 56, no. 11, p. 728-743.
- [12] Alber, B., Rieg, F., Hackenschmidt, R. (2007). Product design with high-tech-polymers – Practical use of CAE-tools with cross-linked simulations and experimental verification. *Materialprüfung*, vol. 49, no. 7-8, p. 402-407.
- [13] Novak, M., Dolšak, B. (2008). Intelligent FEA-based design improvement. *Engineering Application of Artificial Intelligence*, vol. 21, no. 8, p. 1239-1254.
- [14] Pahl, G., Beitz, W., Feldhusen, J., Grothe, K.-H. (2007). *Konstruktionslehre - Grundlagen erfolgreicher Produktentwicklung- Methoden und Anwendung*, Berlin.
- [15] VDI 2221 (1993). *Methodik zum Entwickeln und Konstruieren technischer Systeme und Produkte*. VDI-Handbuch Konstruktion, Berlin - Düsseldorf.

- [16] Hackenschmidt, R., Alber, B., Rieg, F. (2007). Intelligente Verknüpfung von Simulationsprogrammen. CAD-CAM Report, vol. 26, no. 4, p. 34-41.
- [17] Dassault Systèmes (2009). *ABAQUS Analysis User's Manual*. vol. 3, Vélizy-Villacoublay.
- [18] Holden, G. (2000). *Understanding Thermoplastic Elastomers*. Hanser, München.
- [19] Krehmer, H., Eckstein, R., Lauer, W., Roelofsen, J., Stöber, C., Troll, A., Zapf, J., Weber, N., Meerkamm, H., Henrich, A., Lindemann, U., Rieg, F., Wartzack, S. (2010). Das FORFLOW-Prozessmodell zur Unterstützung der multidisziplinären Produktentwicklung. *Konstruktion*, no. 10, p. 59-68.