

Optimizacijski postopek v procesu zasnove zobnikov

Optimisation Feature in Gear Design Procedure

Samo Ulaga - Jože Flašker - Boštjan Zafošnik - Iztok Ciglarič

V prispevku je opisano orodje za optimiranje geometrijske oblike zob kot dodatek k splošnim postopkom zasnove zobnikov. Algoritem omogoča zmanjšanje in enakomerno porazdelitev obrabe in jamičenja zob v ubiru. V postopku optimiranja upoštevamo dva glavna parametra, ki sta odvisna od geometrijske oblike zob: kontaktne napetosti in relativno drsenje. Oba sta odvisna od oblike kontaktne površine, ki pa je v veliki meri odvisna od koeficientov premikov profila. Če želimo doseči čim večjo življenjsko dobo zobnikov, moramo poiskati optimalne vrednosti koeficientov premikov profila, z upoštevanjem vseh preostalih robnih pogojev, ki so predpisani za zasnovo zobnikov. Uporabljen je algoritem adaptivnega izboljšanja mreže. V nadaljevanju prispevka je preverjena oblika zob, dobljena po predlaganem postopku. Prav tako so primerjane in ocenjene drsne razmere za obe obliki zob. Prikazana je možnost uporabe MKE v postopku snovanja zobnikov. Za izračun kontaktnih napetosti je uporabljen algoritem z metodo Lagrangeovih množiteljev po metodi končnih elementov, kontaktne površine pa so dodatno opisane s parametričnimi zlepkami.

© 2001 Strojniški vestnik. Vse pravice pridržane.

(Ključne besede: zasnove zobnikov, dresenje relativno, optimiranje, problemi kontaktni)

In this paper a tooth-geometry optimisation feature is proposed, which is to be added to the general gear-design procedure, so as to provide reduced and equally distributed wear and pitting of mating gear-teeth flanks. Two principal geometry-dependent parameters are considered for the optimisation purposes: contact stress and relative sliding. Both depend on the geometry of the contacting surfaces, which is mainly influenced by the addendum modification coefficient. To maximise the service life of the gear pair, optimum values of this coefficient have to be chosen, in order to satisfy prescribed criteria for specific sliding and Hertz pressure while all the design boundary conditions are fulfilled. An adaptive-grid-refinement algorithm procedure is applied and the gear-flank geometry resulting from the optimisation algorithm is subsequently analysed. The sliding circumstances are compared and evaluated. A FEM contact algorithm using the Lagrange multiplier method and a spline-based geometry definition is applied to calculate the contact stress distribution patterns and to show the applicability of the computational methods to the general gear design.

© 2001 Journal of Mechanical Engineering. All rights reserved.

(Keywords: gear design, relative sliding, optimization, contact problems)

0 UVOD

Kontakt dveh zobnih bokov v ubiru je mogoče obravnavati kot neprilegajoč kotalno-drsni kontakt s trenjem [1], kakor je prikazano na sliki 1. Kotaljenje je vir normalnih napetosti v zobu, drsenje s trenjem pa povzroča strižne napetosti. Če je prekoračena trdnost materiala, se lahko pojavijo poškodbe površine zoba, kar ima za posledico skrajšanje dobe trajanja ali celo zlom zoba.

Relativno drsenje se med ubiranjem zobnih bokov (sl. 1), pojavi kot posledica naslednjega: zaradi kotaljenja prideta točki P_1 in P_2 v kontakt v točki A – začetek ubiranja, medtem

0 INTRODUCTION

The contact of two mating teeth flanks can be described as a non-conforming, rolling-sliding contact with friction, [1], as shown in Figure 1. Due to the rolling, the gears are subject to normal stresses, while the frictional sliding produces shear stresses. Exceeding the material's stiffness can result in damage to the contacting surfaces, and as a result, the service life of the gear pair may be seriously affected or, in the extreme case, the material could fail.

During the mating process, adjacent gear-tooth flanks are subject to relative sliding (Fig. 1) for the following reasons: the rolling of the mating gears, points P_1 and P_2 are brought into contact at point A

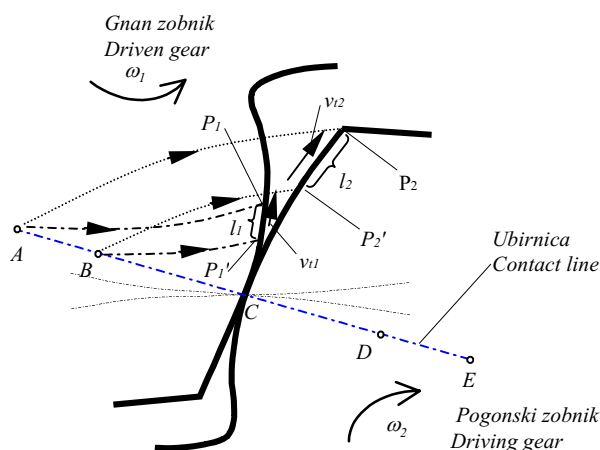

Sl. 1. Kotalno-drsni kontakt zobnikov
Fig. 1. Rolling-sliding contact of gears

ko prideta točki P_1' in P_2' v kontakt v točki B na ubirnici. Posledično bo del zobnega boka l_1 v kontaktu z delom protiboka l_2 . Zaradi različnih dolžin se pojavi relativno drsenje, zaradi česar se obrabi krajši del zobnega boka v kontaktu. V uporabi so metode za analizo razmer med ubiranjem. Najbolj so razširjene različne metode, ki jih predlagajo standardi (DIN, ISO, AGMA). V prispevku je predlagan algoritem za optimiranje obrabe zobnih bokov kot dodatek k postopku zasnove zobnikov, ki ga predlaga standard DIN3990 [2]. V standardnih metodah običajno najprej izberemo parametre, kakor so modul, medosna razdalja in število zob, ki določajo ustrezno vsoto koeficientov premikov profilov (PP) po ISO112/1 [3]. Izračunana vsota je nato porazdeljena med zobnik in pastorek, kakor to predlaga DIN3992 [4]. Na ta način dosežemo navidezno sorazmerno upogibno nosilnost zob, drsne hitrosti in relativno drsenje. Fazi določanja geometrijske oblike zob sledi natančna določitev nosilnosti. Izračunane vrednosti napetosti nato primerjamo z dovoljenimi vrednostmi za izbran material pastorka in zobnika. V prispevku je, z namenom zmanjšati obrabo in jamičenje zobnih bokov, običajnemu postopku dodan algoritem za optimiranje oblike zobnih bokov (sl. 2). Obravnavana je soodvisnost PP, relativnega drsenja in Hertz-ovega tlaka v primeru evolventne valjaste zobniške dvojice.

Definiran je nelinearen problem, z namenom poiskati najboljšo rešitev glede optimalne porazdelitve PP za izbrano zobniško dvojico. Definicija omogoča minimizacijo in optimalno porazdelitev relativnega drsenja glave in korena ISO112/1 [3] zob v ubiranju in posledično zmanjšanje obrabe. Upoštevani so običajni robni pogoji, ki veljajo pri običajnih postopkih zasnove zobnikov: normalne in

— the beginning of engagement; while points P_1' and P_2' come into contact with each other at the engagement point B. Consequently, a flank section l_1 will be in contact with contacting the adjacent flank section l_2 . Due to a difference in their lengths, relative sliding occurs, causing increased wear of the shorter section of the mating flanks. Different methods are available to analyse the contact circumstances during gear meshing, methods suggested by different standards (DIN, ISO, AGMA) are widely used. In this paper a general gear- design procedure, suggested by the DIN3990 standard [2], is examined and some wear optimisation features are suggested. When using the standardised procedure, gear-pair parameters such as module, centre distance and number of teeth are initially defined, and then the accompanying sum of the addendum modification coefficients (AMC), as defined in ISO112/1 [3], is calculated. Its distribution between the pinion and the gear is suggested by DIN3992 [4]. Following the above recommendation, pseudo-proportional bending-load capacity, sliding velocity and relative sliding are assured. The exact bending- and contact-load capacity evaluation follows the geometry definition phase. The calculated values are compared with the allowed values for the pinion and gear material. In the present paper, a gear-teeth-geometry optimisation algorithm is added to the above gear-design procedure in order to reduce the abrasion wear and pitting of mating gear-teeth flanks (Figure 2). The interdependency of the AMC, the specific sliding and the Hertz pressure is analysed for the case of an involute cylindrical gear pair.

A non-linear programming problem is defined in order to find the best solution by means of the optimum AMC distribution values for the selected gear pair. This definition enables minimisation and equal distribution of the relative sliding for the addendum and dedendum flank ISO112/1 [3] of the mating gear teeth, and as a result, minimises the wear of the gear pair. Normal and bending stresses are constrained to

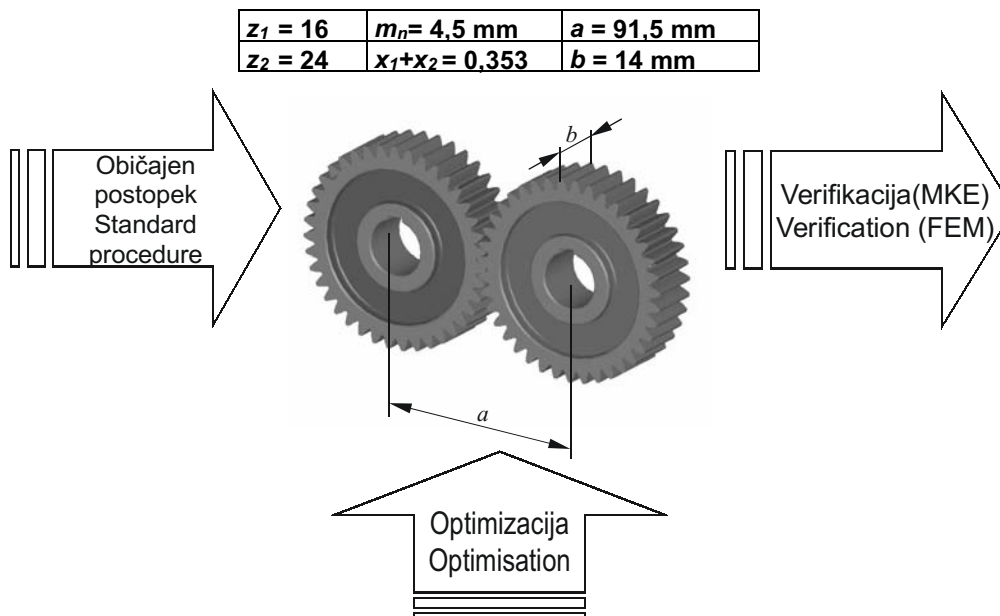

Sl. 2. Način reševanja
Fig. 2. Solution approach

upogibne napetosti znotraj dovoljenih vrednosti, prav tako tudi debelina zoba, stopnja ubiranja in spodrezanje. Optimalna rešitev je določena z uporabo globalnih metod optimiranja. Napetosti, izračunane z običajnim postopkom so primerjane z vrednostmi, dobljenimi po metodi končnih elementov (MKE).

remain within the prescribed values, and other design criteria such as gear-tooth thickness, contact ratio and tooth interference are also considered. An optimum distribution is found using global optimisation methods. Stresses calculated by conventional methods are compared to the numerical solution obtained by the finite-element method (FEM).

1 TEORETIČNE OSNOVE

1 THEORETICAL BACKGROUND

1.1 Drsenje

1.1 Sliding

Kakor je navedeno v različni strokovni literaturi [5], se pojavi relativno drsenje v kontaktnih točkah vzdolž ubirnice zaradi različne dolžine kontaktnih površin vrha in korena zob v ubiranju. Od kinematskega pola C , kjer se drsenje teoretično ne pojavlja, se razlika obodnih hitrosti v_{T1} in v_{T2} v kontaktnih točkah večja proti zunanjim točkam ubiranja A in E (sl. 3).

As a consequence of the different lengths of the addendum and the dedendum flanks (Fig. 1), relative sliding occurs in the contact points along the transverse path of contact Niemann *et al.* [5]. From the pitch point C , where sliding is theoretically zero, the difference between the tangential velocities v_{T1} and v_{T2} at the contacting points increases towards the external points of the engagement A and E respectively (Fig. 3).

Relativno drsenje pomeni razmerje med relativno obodno hitrostjo zobnih bokov v ubiranju in obodno hitrostjo določenega zobnega boka:

Specific sliding represents the ratio between the relative tangential velocity and the tangential velocity of the particular gear-tooth flank:

$$\zeta_1 = \frac{v_{T1} - v_{T2}}{v_{T1}} \quad \zeta_2 = \frac{v_{T2} - v_{T1}}{v_{T2}} \quad (1)$$

v izbrani kontaktni točki Y , kakor prikazuje slika 3. V enačbi (1) pomenita v_{T1} in v_{T2} obodne hitrosti pastorka in zobnika. Obodno hitrost izračunamo kot:

at the particular contacting point Y , as shown in Fig. 3. In (1), v_{T1} and v_{T2} are the tangential velocity of the pinion and gear, respectively. The tangential velocity is calculated as:

$$v_{T1} = \omega_1 \overline{N_1 Y} \quad v_{T2} = \omega_2 \overline{N_2 Y} \quad (2),$$

kjer sta ω_1 in ω_2 kotni hitrosti, $\overline{N_1 Y}$ in $\overline{N_2 Y}$ pa sta razdalji med N_1 oziroma N_2 in trenutno ubirno točko Y . Specifično drsenje imamo lahko za merilo abrazivne

where ω_1 and ω_2 are angular velocities and $\overline{N_1 Y}$ and $\overline{N_2 Y}$ are distances between the engagement point Y and the points N_1 and N_2 , respectively. The specific

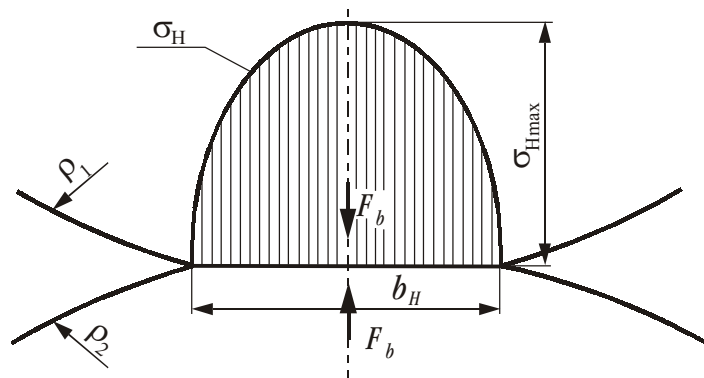

Sl. 4. Hertzova porazdelitev napetosti

Fig. 4. Hertz pressure distribution

voljo preprosti izrazi. V primeru, da sta v kontaktu telesi iz različnih materialov, je treba izračunati nadomestni modul elastičnosti:

$$\frac{1}{E} = \frac{1}{2} \left(\frac{1}{E_1} + \frac{1}{E_2} \right) \quad (4)$$

V primeru kontakta dveh zobnih bokov izračunamo največje napetosti kot:

$$\sigma_{H \max} = \sqrt{\frac{E}{2\pi(1-\nu^2)} \frac{F_b}{b\rho}} = \sqrt{0,175 \frac{E F_b}{2\pi b\rho}} \quad (5)$$

kjer pomenijo: E - Youngov modul, F_b - normalno silo na zobni bok, b - širino zob, ν - Poissonovo število. Povprečni polmer ukrivljenosti ρ v trenutni točki ubiranja Y , izračunamo po enačbi:

$$\frac{1}{\rho} = \frac{1}{\rho_{1Y}} + \frac{1}{\rho_{2Y}} \quad (6)$$

Širino kontaktnega področja izračunamo kot:

$$b_H = \sqrt{\frac{32(1-\nu^2) F_b \rho}{\pi E b}} \quad (7)$$

1.3 Koeficient premika profila

Evolventno ozobje je, v nasprotju od cikloidnega, neobčutljivo na spremembo medosne razdalje. Sprememba medosne razdalje povzroči samo spremembo ubirnega kota. Da ohranimo zvezno in enolično prenašanje krožnega gibanja in zagotovimo predpisano obodno ohlapnost, je treba prilagoditi obliko zobnega profila. Slednje dosežemo s t.i. premikom profila. Izraz pomeni premik referenčnega profila orodja med izdelavo ozobja, in sicer za vrednost xm , kjer m pomeni normalni modul, x pa imenujemo koeficient premika profila (ISO112/1[3]). Za dano zobniško dvojico ob izbrani medosni razdalji in modulu izračunamo ustrezno vsoto PP. Vsaka sprememba PP pomeni spremembo oblike profila zob. Spremenijo se tudi lastnosti zobnikov v ubiru, kakor so prekrivanje zobnih bokov, ukrivljenost

in maksimum value can be calculated using simple formulae. In the case of solids made of two different materials, an equivalent modulus of elasticity has to be defined:

When applied to analyse the line-contact circumstances of the mating gear-teeth flanks, the maximum normal stress can be calculated as:

where E is Young's modulus, F_b is the normal force on the tooth flank, b represents the face width and ν is Poisson's ratio. The mean radius of curvature, ρ , at the engagement point Y , is calculated as:

The width of the contact area is defined as:

1.3 Addendum modification coefficient

Unlike cycloid gear pairs, involute gears are insensitive to changes in centre distance. It only causes an alteration of the pressure angle. To preserve the continuous and uniform transformation of rotary motion, and to retain the prescribed circumferential backlash of the gear teeth, it is necessary to adjust the profile geometry of the teeth. This can be achieved by an addendum modification. It is understood as the tool reference profile shift during the manufacture of the toothed gear by an amount xm , where m represents a normal module and x is termed the addendum modification coefficient, as defined in ISO112/1 [3]. For the particular gear pair at the prescribed centre distance and module the corresponding pressure angle and the sum of the AMC are calculated. Any variation of the AMC results in a changed tooth profile. It also leads to changed properties of the mating gears, such as: meshing interference, tooth flank radii of

zobnih bokov, ubirni kot, debelina korena zob, stopnja ubiranja, medosna razdalja, drsne hitrosti, [8]). Porazdelitev vsote PP, kakršno predlagajo različni standardni postopki za zasnovo zobnikov, ni vedno optimalna glede obrabe in jamičenja zobnih bokov. Izbrani koeficienti PP pa odločilno vplivajo na vsaj dva pomembna parametra obrabe zobnikov (sl. 5). Vrednosti največjih normalnih napetosti v kontaktnih točkah vzdolž ubirnice, izračunane po enačbi (5), so neposredno odvisne od polmera ukrivljenosti na mestu dotika, ta pa je funkcija PP.

curvature, pressure angle, tooth root thickness, contact ratio, centre distance, sliding velocities, etc. (Beitz *et al.* [10]). The distribution of the sum of the AMC, as suggested by standardised gear-design procedures is not always optimum with respect to the abrasion wear and pitting of the mating gear flanks. The shape of the gear tooth following from the selected coefficient of the AMC directly influences at least two important parameters of gear wear (Fig. 5). The maximum value of the normal stress at the contact points along the contact line, calculated from (5), directly depends on the curvature of the contacting surfaces, which is the function of the AMC.

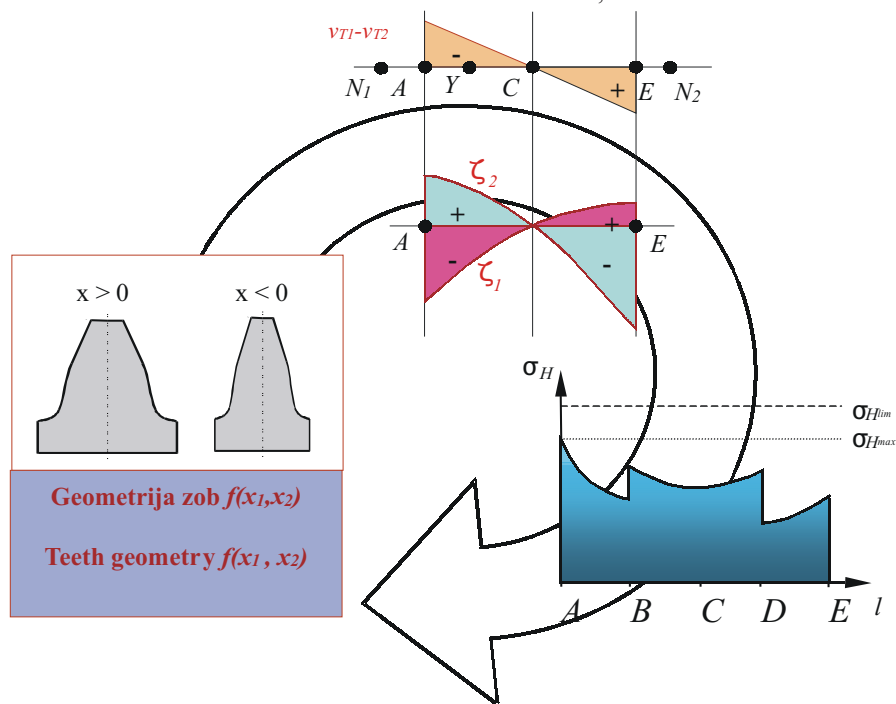

Sl. 5. Soodvisnost parametrov
Fig. 5. Parameter interdependence

Razdalje $\overline{N_i Y}$, $i=1,2$, uporabljene v enačbi (2) so neposredno odvisne od PP. Da bi zmanjšali obrabo, moramo relativno drsenje zmanjšati do najmanjših mogočih vrednosti, medtem ko morajo normalne napetosti ostati znotraj dovoljenih vrednosti. Optimalno porazdelitev PP lahko izračunamo z metodami nelinearnega programiranja.

The distances $\overline{N_i Y}$, $i=1,2$ used in (2) directly depend on the AMC. To reduce the wear of the gear pair, relative sliding has to be reduced to the smallest possible level, while normal stresses must remain below the permissible values. The optimum distribution can be calculated using non-linear programming methods.

2 NALOGA MATEMATIČNEGA PROGRAMIRANJA

2 NON-LINEAR PROGRAMMING PROBLEMS

2.1 Definicija

Veliko nalog s področja optimalnega konstruiranja lahko zapišemo v obliki naloge nelinearnega matematičnega programiranja P , kakor je predlagal Arora v delu [9]:

2.1 Definition

The optimum design can be formulated in the form of a non-linear programming problem P , as stated by Arora [9], which can generally be written as:

$$\min f_0(\mathbf{x}), \mathbf{x} \in \mathbb{R}^k \quad (8),$$

in upoštevamo omejitve

subject to

$$f_i(\mathbf{x}) \leq 0, 1 \leq i \leq h$$

$$x_j \in [\tilde{x}_j, \hat{x}_j], 1 \leq j \leq k$$

kjer so $\mathbf{x} \in \mathbb{R}^k$ vektor projektne spremenljivke, $f_0(\mathbf{x})$ namenska funkcija in $f_i(\mathbf{x}) \leq 0, 1 \leq i \leq h$ omejitvene funkcije, ki definirajo dovoljeno območje S . Vektorja $\tilde{\mathbf{x}}$ in $\hat{\mathbf{x}}$ predstavljata spodnje oziroma zgornje meje projektne spremenljivke, ki jih izberemo tako, da zagotovimo fizikalno primerno rešitve naloge. Rešitev naloge (8) je optimalni vektor projektne spremenljivke $^*\mathbf{x}$. V konkretnem primeru definiramo vektor projektne spremenljivke:

$$\mathbf{x} = [x_1, x_2]^T \quad (9)$$

kjer sta x_1 in x_2 koeficienta profilnega premika, s katerima nadziramo oziroma definiramo geometrijsko obliko zobniške dvojice. Namensko funkcijo definiramo s parametri specifičnega drsenja:

$$f_0(x_1, x_2) := \zeta_1 + \zeta_2 + \zeta_1 \cdot \zeta_2 \quad (10)$$

Namenska funkcija je definirana tako, da minimizacija funkcije hkrati zagotovi najmanjšo absolutno vrednost specifičnega drsenja in minimalno razliko največjih vrednosti specifičnega drsenja za zobna boka v ubiranju. V nadaljevanju definiramo še omejitvene funkcije:

where $\mathbf{x} \in \mathbb{R}^k$ is a parameter or design-variable vector, $f_0(\mathbf{x})$ is the objective function and $f_i(\mathbf{x}) \leq 0, 1 \leq i \leq h$ are constraint functions defining the feasible domain S . Vectors $\tilde{\mathbf{x}}$ and $\hat{\mathbf{x}}$ represent the lower and upper bounds of the design-variable vector, respectively, and are chosen to constrain the parameters to physically attainable values. The solution of the formulation (8) is the optimum design-variable vector $^*\mathbf{x}$. For our purpose, we define the design-variable vector as:

where x_1 and x_2 are the AMC defining and controlling the gear-pair geometry. The objective function is defined by means of specific sliding:

It is formed in a way that enables the minimisation of the absolute magnitude of the specific sliding and also minimises the difference between the maximum values for adjacent tooth flanks. Further, we define the constraint functions:

$$f_1(x_1, x_2) := \sigma_{H \max} - \sigma_{H \lim} \leq 0 \quad (11.1)$$

$$f_2(x_1, x_2) := \sigma_{F \max} - \sigma_{F \lim} \leq 0 \quad (11.2)$$

$$f_3(x_1, x_2) := \frac{d_{a1}}{2} - \sqrt{\left(\frac{d_{b1}}{2}\right)^2 + (a \cdot \sin(\alpha_{wt}))^2} \leq 0 \quad (11.3)$$

$$f_4(x_1, x_2) := \frac{d_{a2}}{2} - \sqrt{\left(\frac{d_{b2}}{2}\right)^2 + (a \cdot \sin(\alpha_{wt}))^2} \leq 0 \quad (11.4)$$

$$f_5(x_1, x_2) := s_{a \min} - d_{a1} \left(\frac{1}{z_1} \left(\frac{\pi}{2} + x_1 \tan(\alpha_t) \right) + \text{inv}(\alpha_t) - \text{inv}(\alpha_{a1}) \right) \leq 0 \quad (11.5)$$

$$f_6(x_1, x_2) := s_{a \min} - d_{a2} \left(\frac{1}{z_2} \left(\frac{\pi}{2} + x_2 \tan(\alpha_t) \right) + \text{inv}(\alpha_t) - \text{inv}(\alpha_{a2}) \right) \leq 0 \quad (11.6)$$

$$f_7(x_1, x_2) := (x_1 + x_2) - \frac{(z_1 + z_2)(\text{inv}(\alpha_{wt}) - \text{inv}(\alpha_t))}{2 \tan(\alpha_n)} = 0 \quad (11.7)$$

$$f_8(x_1, x_2) := \frac{\sqrt{d_{a1}^2 - d_{b1}^2} + \sqrt{d_{a2}^2 - d_{b2}^2} - 2 \cdot a \cdot \sin(\alpha_{wt})}{2 \cdot \pi \cdot m \cdot \cos(\alpha_t)} \geq 1,1 \quad (11.8)$$

Omejitvi (11.1) in (11.2) zagotavljata, da sta največja normalna in upogibna napetost zob v ubiranju manjši od dovoljenih vrednosti konstrukcijskega materiala. Omejitvi (11.3) in (11.4) preprečujeta prekrivanje aktivnih delov zobnih bokov v ubiranju. Ustrezno debelino vrha zoba [10]:

Constraints (11.1) and (11.2) ensure that the maximum calculated normal and bending stresses, respectively, are less than the permissible values for the particular material. Constraints (11.3) and (11.4) prevent interference of the active sections of the tooth flanks from occurring. In order to keep the thickness of the tooth tip greater than the permissible value [10]:

$$s_{a_{\min}} = 0,4 \cdot m \quad (12)$$

zagotavljata omejitvi (11.5) in (11.6), upoštevani v formulaciji naloge. Omejitev (11.7) je upoštevana z namenom, da zagotovimo konstantno vsoto koeficientov profilnega premika in omejitev (11.8) z namenom, da zagotovimo stopnjo profilnega ubiranja manj ko 1,1. Izrazi, uporabljeni v (11), so dobro znani v literaturi [5], ki obravnava konstruiranje zobnikov.

2.2 Rešitev naloge

Naloga nelinearnega matematičnega programiranja je rešena z uporabo globalne optimizacijske metode. Uporabljen je algoritem prilagodnega izboljševanja mreže (AGR), ki smo ga uvedli v okolju Mathematica [11]. Algoritem AGR spada med hevristične deterministične metode [12]. Načelo delovanja algoritma AGR je naslednje. Na definicijskem območju, na katerem je rešitev, ustvarimo n začetnih točk na enakih medsebojnih razdaljah (sl. 6)

constraints (11.) and (11.6) are applied to our formulation. Finally, constraint (11.7) is imposed in order to ensure that the sum of the AMC is constant, and the constraint (11.8) is to prevent a contact ratio of less than 1.1 appearing. Expressions in (11) are well known from the literature dealing with gear design [7].

2.2 Solution approach

The global optimisation method is used in the present work. An Adaptive Grid Refinement (AGR) algorithm within Mathematica [11] is applied. The AGR algorithm is, in essence, a generalised-descent method. These methods are [12] classified as heuristic deterministic methods. They are based on the evolution of the cost function and its change only along certain paths, each considered as a design history as a function of time from starting point to minimum point at the current iteration. The algorithm works as follows. The interval to be searched for a solution is covered by a grid of n initial equi-distant grid points (Fig. 6).

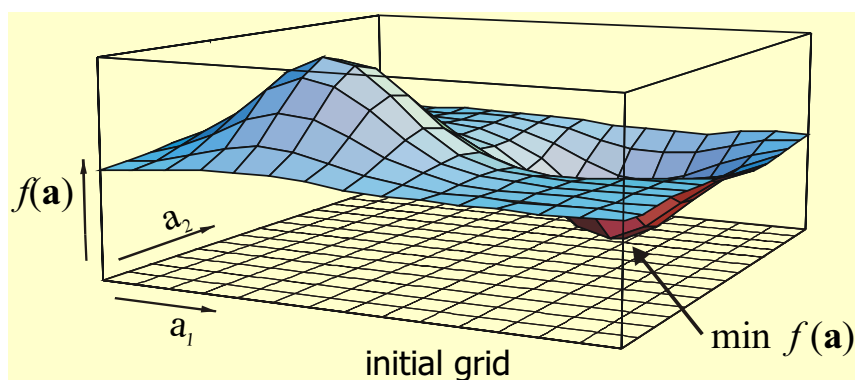

Sl. 6. Omreženo področje - simbolično
Fig. 6. Symbolic grid domain

V vsaki točki izračunamo vrednost namenske funkcije. Točke, v katerih je vrednost namenske funkcije relativno manjša, prenesemo v naslednjo iteracijo, preostale točke pa zavržemo in izločimo iz nadaljnega postopka. Ob vsaki obdržani točki algoritem ustvari novi točki, ki sta od začetne točke oddaljeni za tretjino začetne razdalje med točkami. Ponovno izračunamo vrednosti namenske funkcije v novih točkah. Iterativni postopek zgoščevanja mreže, določanja vrednosti namenske funkcije in izbire možnih rešitev se ponavlja, dokler niso izpolnjeni podani konvergenčni kriteriji. Vrednost namenske funkcije v točkah se z iteracijami zmanjšuje, in sicer v različnih smereh za več delov definicijskega območja. Enak postopek v splošnem poteka za poljubno število projektnih spremenljivk, vendar se s tem eksponentno poveča tudi število mrežnih vozlišč, kar je povezano z znatnim povečanjem numerične zahtevnosti. Algoritem je nadvse robusten, ne zahteva zveznosti in

At each point, the objective function is evaluated. The best points with the lowest objective function values are kept, while the rest are excluded from the subsequent procedure. For each kept point, the new points are evaluated on each side at one-third distance between the first set of points. The objective function value is evaluated once again for the new points. This process of grid refinement continues until a termination criterion is met. When the above procedure is applied, the population of the working set is reduced over the iterations while the solution set can spread over multiple possible regions and directions. The same procedure can be used for any of the design variables, although the number of grid points and computation effort increases exponentially with the number of design variables. The algorithm acts in a very stable way and

odvedljivosti namenske funkcije ter dobro obvladuje tudi definicijsko območje, podano z zahtevnejšimi omejitvenimi pogoji.

3 REZULTATI IN NJIHOVA POTRDITEV

3.1 Rezultati

Predlagan postopek optimalnega projektiranja smo uporabili na primeru valjaste zobniške dvojice, definirane s parametri, prikazanimi na sliki 2. Pri tem smo predpisali naslednje spodnje in zgornje meje projektnih spremenljivk:

$$\begin{aligned}\bar{\mathbf{x}} &= [-0,4, -0,4]^T \\ \bar{\mathbf{x}} &= [1,2, 1,2]^T\end{aligned}\quad (13),$$

ki pomenijo običajne mejne vrednosti stopnje profilnega premika [5]. S predlaganim algoritmom smo izračunali naslednje optimalne vrednosti koeficientov profilnega premika:

$$\mathbf{x} = [0,307; 0,046]^T \quad (14).$$

Optimalna rešitev izpolnjuje tudi omejitve, podane z izrazi (11). Kljub temu je treba poudariti, da mora izračunane vrednosti pred uporabo oceniti še izkušen snovalec zobniških gonil.

3.2 Overitev

V postopku overitve oblike zob, dobljene z optimizacijskim algoritmom, so bile uporabljene analitične in numerične metode. Za porazdelitev PP po enačbi (15), kakor jo predlaga DIN3992 [4], je bil v vsaki od značilnih točk vzdolž ubirnice (A, B, C, D, E) izračunan polmer ukrivljenosti:

$$\mathbf{x}_0 = [0,23; 0,12]^T \quad (15).$$

Zgornje vrednosti so bile izračunane tudi za porazdelitev PP, kakor jo predlaga optimizacijski algoritem (13). Za obe porazdelitvi PP je bil izračunan Hertzov tlak. Rezultate kaže slika 7.

Da bi potrdili učinkovitost predlaganega algoritma, je bilo v vseh točkah izračunano še relativno drsenje. Primerjavo vrednosti prikazuje slika 8. Kakor je razvidno s slik 7 in 8, so tako vrednosti Hertzovega tlaka, kakor tudi relativnega drsenja manjše in bolj enakomerno porazdeljene v primeru optimirane porazdelitve PP. Na podlagi prikazanega je moč sklepati, da bo obraba zobnih bokov zobnikov, oblikovanih na način, kakor je predlagano z optimizacijskim algoritmom, manjša in bolj enakomerna. Da dokažemo pravilnost postopka, smo enak algoritem uporabili še za optimiranje porazdelitve koeficientov PP zobniške dvojice z naslednjimi podatki: $P=25\text{kW}$, $n_1=700\text{min}^{-1}$, $i=3$, $z_1=21$, $m_n=4\text{mm}$, $a=170\text{mm}$. Rezultati so podani na sliki 8a.

requires no calculation of the derivatives. It can also handle discontinuities and calculations in the vicinity of a complex constraint boundary.

3 OPTIMISATION RESULTS AND VERIFICATION

3.1 Optimisation results

To verify the suggested approach, a spur gear pair was analysed, defined by the parameters given in Figure 2. The upper and lower bounds of the design-variable vector are:

respectively, and represent common gear-design limits [5]. Using the presented algorithm, the following results were obtained:

Where the constraints of equations (11) were considered as well. Nevertheless, it should be pointed out, that the experienced gear designer should always review the computational results, prior to the final decision.

3.2 Verification

Analytical and computational methods were used to verify the geometry obtained by the optimisation algorithm. The radii of curvature at every characteristic contact point along the path of contact (A, B, C, D, E) was calculated for the distribution of the AMC suggested by the standard procedure (DIN3992 [4]):

and the calculated optimum distribution (13) of the AMC. The Hertz pressure was calculated at every characteristic contact point (continuous line) and compared to the values obtained for a non-optimum distribution (dashed line). The results are presented in Figure 7.

To establish the efficiency of the suggested algorithm, relative sliding at each of the typical contact points was calculated as well, as shown in Figure 8. As can be seen from Figures 7 and 8, respectively, the normal pressure and relative sliding values for the optimised AMC distribution are lower and more equally distributed. Consequently, it can be assumed that the expected abrasion wear of the gear-teeth flanks, shaped in accordance with the optimisation algorithm, will be reduced and equally distributed. To prove the regularity of the approach, the same algorithm was used for another gear pair with the following data: $P=25\text{kW}$, $n_1=700\text{rpm}$, $i=3$, $z_1=21$, $m_n=4\text{mm}$, $a=170\text{mm}$. The results are presented in figure 8a.

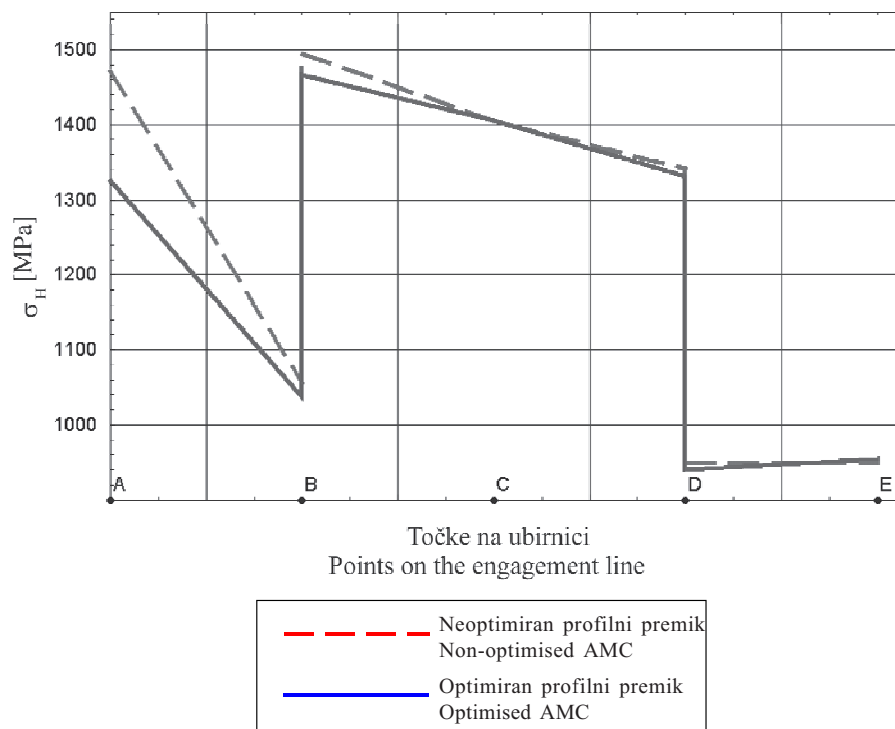

Sl. 7. Porazdelitev Hertzovega tlaka vzdolž ubirnice v MPa
 Fig. 7. Hertz pressure distribution along the path of contact in MPa

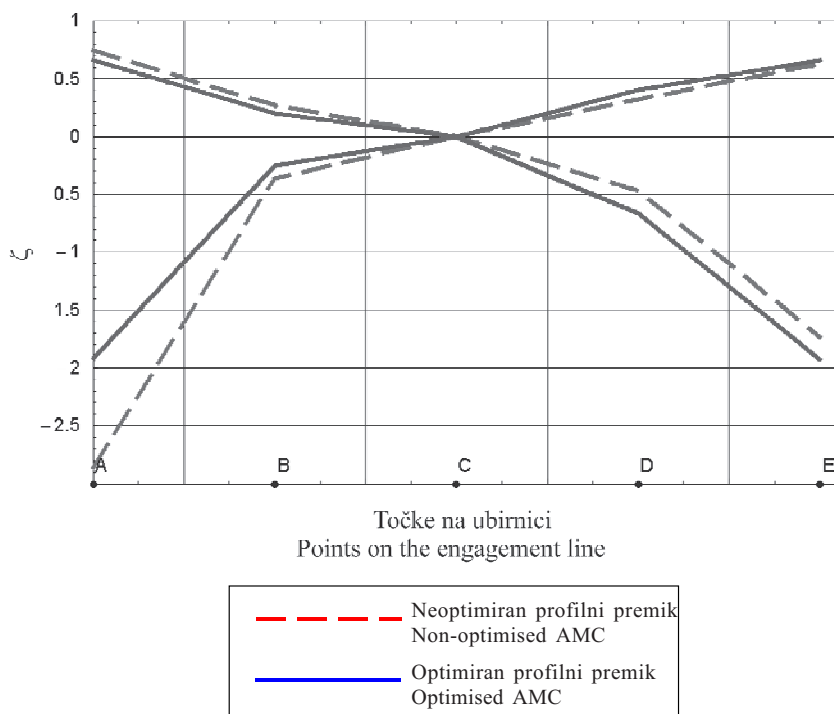

Sl. 8. Porazdelitev specifičnega drsenja vzdolž ubirnice
 Fig. 8. Specific sliding distribution along the path of contact

3.2.1 Uporaba MKE v postopku snovanja zobnikov

Porazdelitev normalnih napetosti v analizirani zobniški dvojici je bila, z namenom prikaza uporabnosti numeričnih metod, izračunana z metodo končnih elementov. Uporabljen je bil lasten program za analizo kontaktnih problemov,

3.2.1 Application of the FEM in general gear design

To demonstrate the applicability of computational tools in the gear-design process, the normal stress distribution of the analysed gear pair was calculated using the finite-element method (FEM). An in-house contact code, based on the FEM

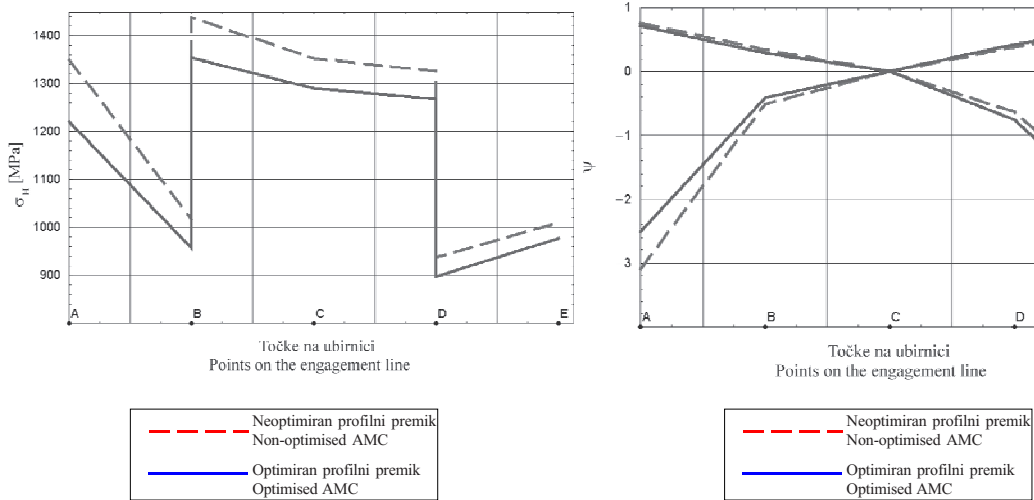

Sl. 8a. Porazdelitev specifičnega drsenja in Hertz-ovega tlaka vzdolž ubirnice
 Fig. 8a. Specific sliding and Hertz pressure distribution along the path of contact

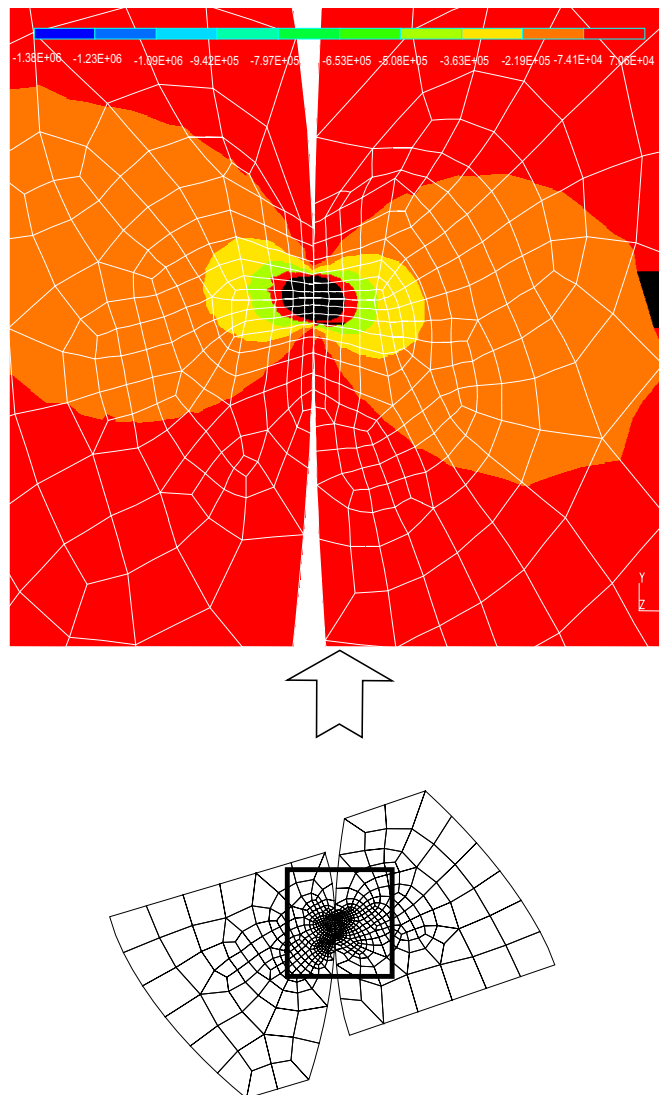

Sl. 9. Kontaktne napetosti po MKE za optimirano obliko zob – točka B
 Fig. 9. FEM contact stresses distribution for optimum tooth profile – B point

ki sloni na metodi končnih elementov [13]. V programu je za predpisovanje kontaktnih robnih pogojev uporabljena metoda Lagrangeovih množiteljev. Ker MKE ne daje 'gladkega' opisa analizirane geometrijske oblike, je bil uveden dodaten opis kontaktnih robov s pomočjo Overhauserjevih parametričnih zlepkov, ki omogoča preprosto in natančnejše zaznavanje kontakta in izračunavanje velikosti prodiranja. Program omogoča še nekatere koristne funkcije, to je Prosti algoritem Lagrangea-Eulerja (Arbitrary Lagrange-Euler Algoritem - ALE) [14] za razdelitev kotalnega kontakta na enostavnejše odseke. Za zmanjšanje števila prostostnih stopenj so v algoritmu na voljo posplošeni robni pogoji [15], ki omogočajo, da s povezovalnimi izrazi povežemo poljubno število prostostnih stopenj. Za optimirano in neoptimirano obliko zob so bile izračunane normalne napetosti. Na spodnji sliki je prikazan primer porazdelitve normalnih napetosti, za optimirano porazdelitev PP (14), izračunanih s pomočjo kontaktnega algoritma po MKE.

Predlagan algoritem MKE je uporaben za modeliranje kontaktnih pogojev med ubiranjem zob. Algoritem omogoča modeliranje dejanske geometrijske oblike zobnih profilov, trenja, toplotnih obremenitev, različnih elastičnih lastnosti materiala [13] itn. Prednost uporabe MKE pred običajnimi postopki je v tem, da poleg ekstremnih vrednosti ponujajo tudi celotno porazdelitev napetosti v telesu. Slednje je nujno za napovedovanje jamičenja in drugih oblik poškodb zobnikov. Pomanjkljivost uporabe MKE v postopku snovanja zobnikov je, da moramo, če želimo natančno modelirati geometrijsko obliko zob, uporabiti v okolici kontakta zelo gosto mrežo. Posledica so bistveno povečani računski časi.

4 SKLEP

V prispevku je predlagana uporaba različnih vrst inženirskih znanj, združenih v uporabna konstruktorska orodja. Standardnemu postopku konstruiranja zobniških gonil so dodane nove funkcije, ki izboljšajo učinkovitost. Predstavljen je algoritem za optimiranje porazdelitve koeficientov premikov profila. Optimalna rešitev je poiskana glede na relativno drsenje in dovoljene normalne napetosti ter ob upoštevanju splošnih robnih pogojev za konstruiranje zobnikov. Uporabljena je globalna optimizacijska metoda, in sicer algoritem prilagodnega izboljševanja mreže. Vzdolž ubirnice so za optimirano obliko zob preverjene vrednosti relativnega drsenja in normalnih napetosti. Rezultati so primerjani z vrednostmi, izračunanimi za

was used for the gear design [13]. The Lagrange multiplier method was used for the imposition of the contact boundary conditions. A redundant geometry definition was used to avoid a non-smooth geometry description provided by the FE shape function. Overhauser splines were used for the gear design providing simplified and more accurate contact detection and penetration-size calculation. Some other useful features were used within the computer program as well, and an Arbitrary Lagrangian Eulerian (ALE) algorithm for a decomposition of the rolling contact was applied [14]. To reduce the number of degrees of freedom, a system of generalised constraints, as suggested [15] was introduced, enabling arbitrary degrees of freedom to be linked by specified expressions to maintain desired relations. Optimised and non-optimised profiles of the gear teeth were modelled and the normal stresses calculated. Some results of the FEM contact algorithm for the optimum AMC distribution (14) are presented in the following figure.

The proposed FE algorithm is capable of modelling the contact conditions during the gear-teeth mating. It also allows for consideration of the real tooth profile; the friction and temperature loading; and the different elastic properties of the mating materials [13], etc. There are many reasons for proposing the application of computational methods in combination with conventional ones. Contact interaction between any two or more mechanical components can significantly affect their operating conditions. Due to their importance it is imperative to gain a proper insight into the process of contact interactions. FE analyses provide the complete stress-strain distribution of the mating gear teeth, which is necessary for predicting the possibility of pitting and other forms of gear failure. From the users' point of view it should be stressed that a comprehensive knowledge of general gear design is necessary to be able to use the computational tools properly.

4 CONCLUSIONS

In this work, an attempt to bring together different areas of engineering knowledge to create a useful design tool is presented. Some novel features within a general gear-design procedure are applied in the work to improve the efficiency of the standard gear-design procedures. An optimisation algorithm for the addendum modification coefficient distribution is presented. An optimum distribution is found with respect to the specific sliding and permissible Hertz pressure, taking general gear-design constraints into account. The global optimisation method is used for the above purpose. An adaptive grid refinement algorithm is applied. The gear-tooth profile resulting from the optimisation procedure is tested in terms of the specific sliding and the normal pressure distribution along the transverse path of the contact. Results are compared for the optimised and non-optimised AMC distribution. A FEM contact algorithm

neoptimirano obliko. Ugotovljeno je, da so vrednosti normalnih napetosti in relativnega drsenja za optimirano obliko zoba manjše in bolj enakomerno porazdeljene. Na podlagi prikazanih rezultatov lahko sklepamo, da je podani algoritem primeren za uporabo pri konstruiranju zobniških gonil. Uporabljen je tudi kontaktni algoritem po MKE, kot primerjava z analitičnimi postopki snovanja zobnikov.

is used to compare the analytical and computational gear-design procedures. It was established that the relative sliding and Hertz pressure of the mating tooth flanks of pinion and gear resulting from the calculated optimum AMC distribution are reduced and more equally distributed. From the presented results it can be concluded that the proposed approach is applicable to the general-purpose gear-design procedure, but it will be tested on an extensive selection of cases prior to it being proposed for general use.

5 OZNAKE 5 SYMBOLS

stične točke	P_1, P_2, P_1', P_2'	points of contact
značilne točke vzdolž ubirnice	A, B, C, D, E	characteristic points along the line of contact
del zobnega boka	f_1, f_2	teeth flank section
obodna hitrost	v_{T1}, v_{T2}	circumferent velocity
kotna hitrost	ω_1, ω_2	angular velocity
število zob	z_1, z_2	gear teeth number
normalni modul	m	normal modulus
medosna razdalja	a	centre distance
koeficient premika profila	x_1, x_2	addendum modification coefficient
širina zobnika	b	tooth face width
debelina vrha zoba	s_a	tooth tip thickness
medsebojno drsenje	ζ_1, ζ_2	specific sliding
trenutna točka stika	Y	actual point of contact
robne točke uporabnega področja ubiranja	N_1, N_2	boundary points of the utilisable domain
premer temenskega kroga	d_{a1}, d_{a2}	tip diameter
premer korenskega kroga	d_{b1}, d_{b2}	base diameter
premer kinematičnega kroga	d_{w1}, d_{w2}	pitch diameter
dejanski polmer ukrivljenosti	ρ_{1y}, ρ_{2y}	actual radii of curvature
vrtišče zobnikov	O_1, O_2	gear centre of rotation
ubirni kot na delilnem krogu	α_t	transverse pressure angle
ubirni kot na kinematičnem krogu	α_{wt}	working transverse pressure angle
ubirni kot na temenskem krogu	α_{a1}, α_{a2}	pressure angle at tip diameter
nagibni kot bočnic	β	helix angle
modul elastičnosti	E, E_1, E_2	modulus of elasticity
normalna napetost	σ_H	normal stress
največja izračunana normalna napetost	σ_{Hmax}	maximum calculated normal stress
dovoljena normalna napetost	σ_{Hlim}	permissible normal stress
upogibna napetost	σ_F	bending stress
dovoljena upogibna napetost	σ_{Flim}	permissible bending stress
normalna sila	F_b	normal force
Poissonovo število	ν	Poisson's ratio
širina stičnega področja	b_H	width of the contact area
nelinearen problem programiranja	P	non-linear programming problem
ciljna funkcija	f_0	objective function
omejitvena funkcija	f_i	constraint function
projektna spremenljivka	x	design variable
definijsko območje	R^k	domain space
dovoljeno območje	S	feasible domain
spodnja in zgornja meja projektne spremenljivke	\tilde{x}, \hat{x}	variable lower and upper band
optimalni vektor projektnih spremenljivk	x^*	optimal solution vector

6 REFERENCES

6 REFERENCES

- [1] Zhong, Z. H. (1993) Finite element procedures for contact–impact problems, *Oxford University Press*.
- [2] DIN 3990 (1996) Tragfähigkeitberechnung von Stirnrädern, Deutsch Norme, *Beuth Verlag*.
- [3] ISO 1122/1 (1983) Glossary of gear terms
- [4] DIN 3992, Ausgabe:1964-03 (1996) Profilverziehung bei Stirnrädern mit Außenverzahnung, Deutsch Norme, *Beuth Verlag*.
- [5] Niemann, G., H. Winter (1985) Maschinenelemente – Band II, *Springer-Verlag*.
- [6] Obersmit, E. (1982) Ozubljenja i zupčanici, *SNL, Zagreb*, 593 p.
- [7] Johnson, K. L. (1985) Contact mechanics, *Cambridge University Press*.
- [8] Beitz, W., K.H. Küttner (1983) Dubbel – Taschenbuch für den Maschinenbau, *Springer-Verlag*.
- [9] Arora, J.S., O.A. Elwakeil, A.I. Chahande and C.C. Hsieh (1995) Global optimization methods for engineering applications: a review, 1995. Structural optimization Vol. 9, No. 3/4, 137-159, *Springer-Verlag, Editor: G. Rozvany*.
- [10] Decker, K. H. (1985) Maschinenelemente – Gestaltung und Berechnung, *Carl Hanser Verlag, München*, 576 p.
- [11] Global nonlinear optimization using Mathematica (user manual). Loehle Enterprises, 1258 Windemere Ave. Naperville, IL 60564.
- [12] Arora, J.S., O.A. Elwakeil, A.I. Chahande and C.C. Hsieh (1995) Global optimization methods for engineering applications: a review, 1995. Structural optimization Vol. 9, No. 3/4, 137-159, *Springer-Verlag, Editor: G. Rozvany*.
- [13] Ulaga, S. (1998) Extended algorithm for contact problems using finite element method, PhD thesis, *University of Maribor - Slovenia*, (In Slovene, abstract in English), 127 p.
- [14] Nackenhorst, U. (1993) On the finite element analysis of steady state rolling contact, *Proceedings of the 1st International Conference on Computational Methods in Contact Mechanics, CMP*, Southampton, 53-60.
- [15] Hellen, T.K., A.B. Haines (1972) Generalised constraints for finite elements and their application to curve-bladed pump impellers, *CEGB Report, RD/B/N2252*.
- [16] Glodež S., Z. Ren (1998) Modelling of crack growth under cyclic contact loading. *Theor. appl. fract. mech.*, 30, Vol. 2, 159-173.
- [17] Glodež, S., Z. Ren, G. Fajdiga (2001) Computational modelling of the surface fatigue crack growth on gear teeth flanks. *Commun. numer. methods eng.*, vol. 17, no. 8, 529-541.
- [18] Kramberger, J. (2001) Širjenje razpok v zobnikih s tankim vencem: Doktorska teza/PhD thesis, University of Maribor - Slovenia.
- [19] Šraml, M. (2001) Modeliranje kontaktnega utrujanja strojnih delov: Doktorska teza/PhD thesis, *University of Maribor - Slovenia*.

Naslova avtorjev: dr. Samo Ulaga
 prof.dr. Jože Flašker
 mag. Boštjan Zafošnik
 Fakulteta za strojništvo
 Univerza v Mariboru
 Smetanova 17
 2000 Maribor

dr. Iztok Ciglarič
 Univerza v Ljubljani
 Fakulteta za strojništvo
 Aškerčeva 6
 1000 Ljubljana

Authors' Addresses: Dr. Samo Ulaga
 Prof.Dr. Jože Flašker
 Mag. Boštjan Zafošnik
 Faculty of Mechanical Eng.
 University of Maribor
 Smetanova 17
 2000 Maribor, Slovenia

Dr. Iztok Ciglarič
 Faculty of Mechanical Eng.
 University of Ljubljana
 Aškerčeva 6
 1000 Ljubljana, Slovenia

Prejeto:
 Received: 3.9.2001

Sprejeto:
 Accepted: 12.10.2001